

Stratos MS A405

pH Measurement

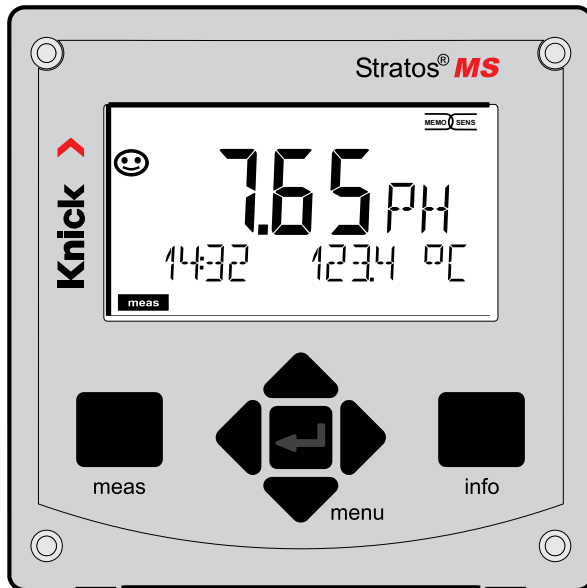

Read before installation.
Keep for future use.

Supplemental Directives

Read this document and retain it for future reference. Before assembling, installing, operating, or maintaining the product, ensure that you fully understand the instructions and risks. Observe all safety instructions. Failure to follow the instructions in this document may result in serious injury and/or property damage.

This document is subject to change without notice.

These supplemental directives explain how safety information is laid out in this document and what content it covers.

Safety Chapter



This document's Safety chapter is designed to give the reader a basic understanding of safety. It illustrates general hazards and gives strategies on how to avoid them.

Safety Guide

The external Safety Guide is designed to give the reader a basic understanding of safety. It illustrates general hazards and suggests strategies on how to avoid them.

Warnings

This document uses the following warnings to indicate hazardous situations:

Symbol	Category	Meaning	Remark
	WARNING	Designates a situation that can lead to death or serious (irreversible) injury.	The warnings contain information on how to avoid the hazard.
	CAUTION	Designates a situation that can lead to slight or moderate (reversible) injury.	
None	NOTICE	Designates a situation that can lead to property or environmental damage.	

Additional Safety Information

Stratos Safety Guide

Table of Contents

Supplemental Directives	2
Documents Supplied	5
Safety	6
Intended Use.....	7
Introduction	8
Assembly	9
Package Contents.....	9
Mounting Accessories	10
Pipe Mounting, Protective Hood	11
Panel Mounting	12
Electrical Installation	13
Terminal Assignments, Rating Plates	13
Power Supply	14
Start-Up	15
Calibration and Maintenance in the Lab	15
Measuring Mode	17
The Keys and Their Functions	18
The Display	19
Signal Colors (Display Backlighting).....	19
Display in Measuring Mode	20
Operating Modes	22
HOLD Mode.....	23
Operating Modes / Functions.....	24
Menu Structure of Configuration	25
Connecting a Memosens Sensor	26
Replacing a Sensor.....	27
Configuration	28
Configuration: Overview	28
Configuring the Sensor	32
Device Type: pH	32
Sensor Verification (TAG, GROUP)	34
Configuring the Current Output.....	36

Table of Contents

Configuring the Alarm.....	42
Temperature Compensation	44
Configuring the Relay Contacts	46
Protective Wiring of Relay Contacts.....	54
Configuring the Time/Date.....	56
Calibration	58
Automatic Calibration	60
Manual Calibration	62
Premeasured Sensors	64
Slope: Converting % to mV.....	65
ORP (Redox) Calibration.....	66
Product Calibration.....	68
Measurement.....	70
Diagnostics	71
Service	76
Operating Error!.....	79
Error Messages.....	81
Sensocheck and Sensoface	83
Decommissioning.....	84
Disposal	84
Returns.....	84
Operating States.....	85
Product Range	86
Specifications.....	87
Buffer Tables	91
-U1- Specifiable Buffer Set	104
Index.....	107

Safety Guide

In official EU languages and others

Quickstart Guides

Installation and first steps:

- Operation
- Menu structure
- Calibration
- Error messages and recommended actions

Test Report 2.2 According to EN 10204

Electronic Documentation

www.knick-international.com:

Manuals + software

Safety

Always Read and Observe the Safety Instructions!

The device is constructed in accordance with the latest technology and generally accepted safety rules and regulations.

Under certain circumstances, however, usage may pose risks to users or cause damage to the device.

Commissioning must be carried out by specialist personnel authorized by the operating company. If safe operation is not possible, the device must not be switched on or, if it is already on, must be switched off properly and secured against unintended operation.

Reasons to assume safe operation is not possible:

- the device shows visible damage
- failure to perform the intended function
- prolonged storage at temperature of below $-30\text{ }^{\circ}\text{C}/-22\text{ }^{\circ}\text{F}$ or above $70\text{ }^{\circ}\text{C}/158\text{ }^{\circ}\text{F}$
- severe transport stresses

Before recommissioning the device, a professional routine test must be performed. This test should be carried out by the manufacturer at its factory.

Mains Connection

The device does not have a power switch. An appropriately arranged and accessible disconnecting device for the transmitter must be present in the system installation. The disconnecting device must disconnect all non-grounded, current-carrying wires. The disconnecting device must be labeled in a way that enables the associated transmitter to be identified. The power line may carry dangerous touch voltages. Touch protection must be ensured by proper installation.

Personnel Requirements

Customer shall ensure that any personnel using or otherwise interacting with the product is adequately trained and has been properly instructed.

The operating company shall comply and cause its personnel to comply with all applicable laws, regulations, codes, ordinances and relevant industry qualification standards related to product. Failure to comply with the foregoing shall constitute a violation of operating company's obligations concerning the product, including but not limited to an unintended use as described in this document.

Intended Use

Stratos MS is a 4-wire analyzer for use with Memosens sensors. Current is provided through a universal power supply 80 ... 230 V AC, 45 ... 65 Hz / 24 ... 60 V DC. The analyzer provides two 0 (4) ... 20 mA current outputs for transmission of measured value and temperature, for example.

Two floating relay contacts are available for free configuration.

You can select one of the following measuring functions:

- pH
- ORP
- Dissolved oxygen
- Conductivity measurement (conductive/inductive)

The defined rated operating conditions must be observed when using this product. They can be found in the Specifications chapter of this User Manual; see page 87.

Function Check Mode (HOLD Function)

After activating configuration, calibration, or service, Stratos MS enters function check mode (HOLD).

The current outputs respond in accordance with the configuration.

Operations must not be carried out while Stratos Pro is in function check (HOLD) mode, as the system may behave unexpectedly and put users at risk.

Introduction

Enclosure and mounting possibilities

- The sturdy molded enclosure is rated IP66/IP67 / TYPE 4X Outdoor.

Material of front unit: PBT, rear unit: PC.

Dimensions: H 148 mm, W 148 mm, D 117 mm.

It is provided with knockouts to allow:

- panel mounting (138 mm x 138 mm cutout to DIN 43700)
- wall mounting (with sealing plugs to seal the enclosure)
- post/pipe mounting (dia. 40 ... 60 mm, □ 30 ... 45 mm)

Protective hood (accessory)

The protective hood provides additional protection against direct weather exposure and mechanical damage (available as accessory).

Connection of sensors, cable glands

For connecting the cables, the enclosure provides

- 3 knockouts for cable glands M20x1.5
- 2 knockouts for NPT 1/2" or rigid metallic conduit

For quasi-stationary installations with Memosens sensors, we recommend using the M12 socket accessory (ZU0822) instead of a cable gland – which allows simple replacement of the sensor cable without opening the device.

Memosens sensors and connecting cables

Please visit our website for more information on our product range: www.knick.de.

Package Contents

Check the shipment for transport damage and completeness.

The package should contain:

Front unit, rear unit, bag containing small parts

Specific test report

Documentation

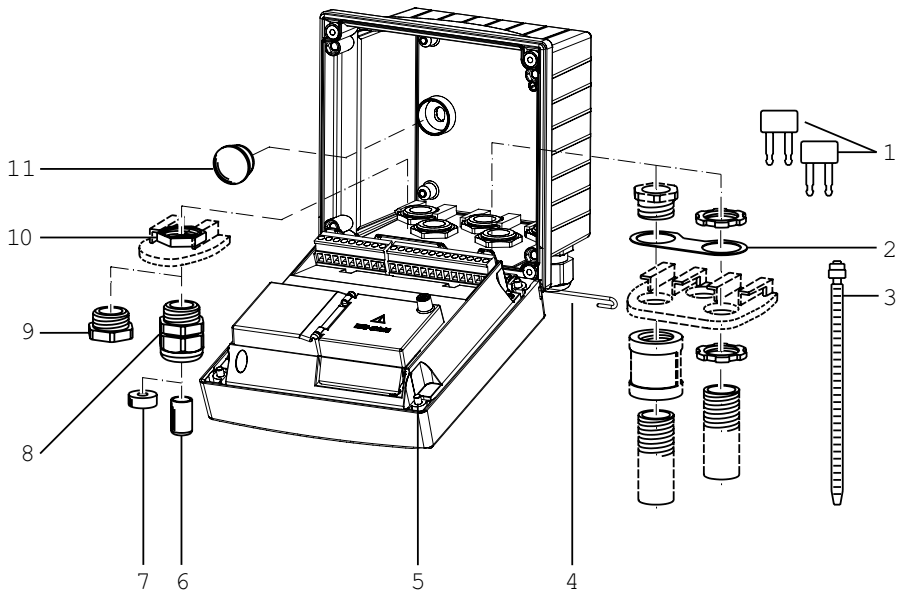
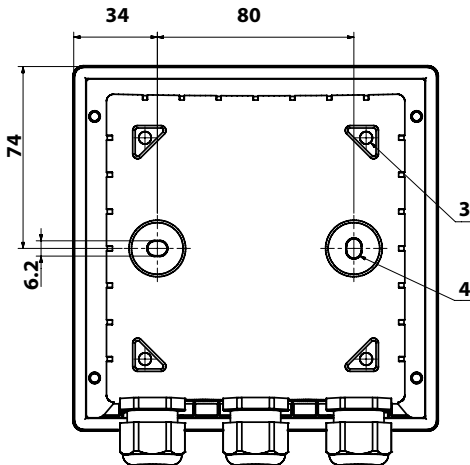
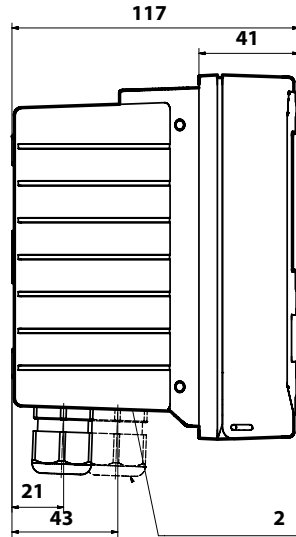
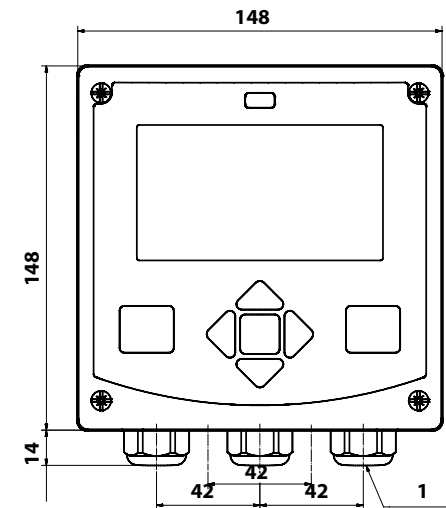

Fig.: Assembling the enclosure

- | | |
|---|--|
| 1) Insertable jumper (3x) | 6) Blanking plug (2x) |
| 2) Plate (1x), for conduit mounting:
Plate between housing and nut | 7) Reduction sealing insert (1x) |
| 3) Cable tie (3x) | 8) Cable gland (3x) |
| 4) Hinge pin (1x), insertable from
either side | 9) Blanking cap (2x) |
| 5) Enclosure screw, captive (4x) | 10) Hex nut (5x) |
| | 11) Plastic sealing plug (2x),
for sealing in case of wall mounting |

Mounting Plan, Dimensions



- 1) Cable gland (3x)
- 2) Knockouts for cable gland or $\frac{1}{2}$ " conduit, dia. 21.5 mm (2 knockouts).
Conduit couplings not included!
- 3) Knockout for pipe mounting (4x)
- 4) Knockout for wall mounting (2x)

Mounting Accessories

Pipe-mount kit, accessory ZU0274

Protective hood for wall and pipe mounting, accessory ZU0737

Panel-mount kit, accessory ZU0738

All dimensions in mm

Pipe Mounting, Protective Hood

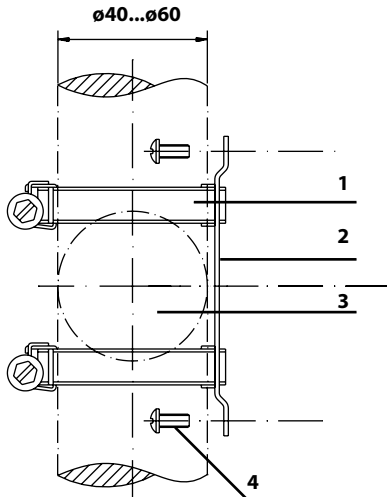

- 1) Hose clamp with worm gear drive to DIN 3017 (2x)
- 2) Pipe-mount plate (1x)
- 3) For vertical or horizontal posts or pipes
- 4) Self-tapping screw (4x)

Fig.: Pipe-mount kit, accessory ZU0274

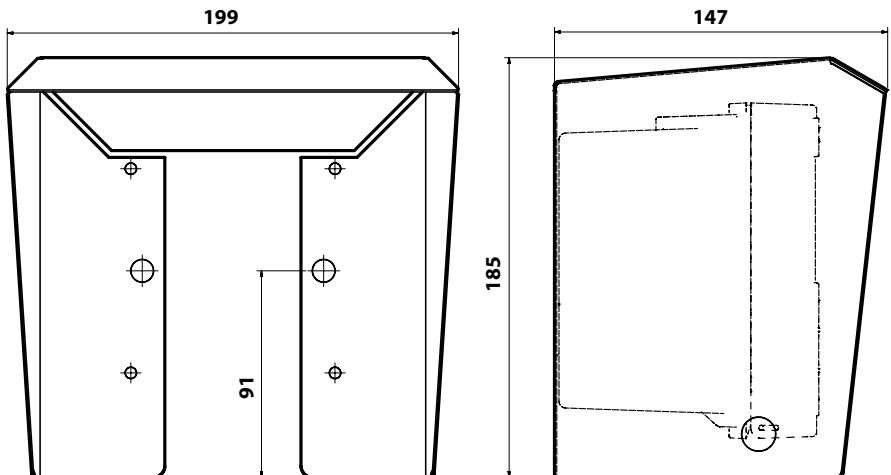
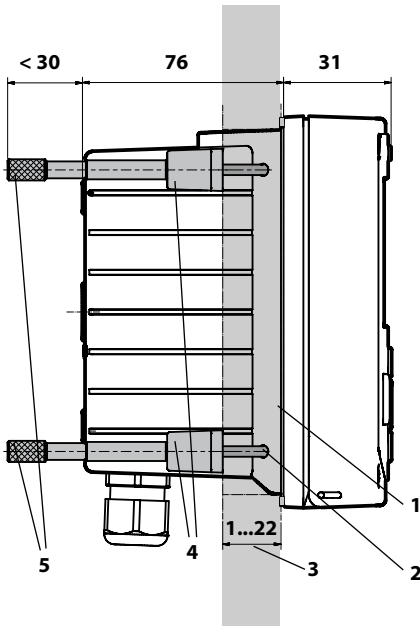

Fig.: Protective hood for wall and pipe mounting, accessory ZU0737

All dimensions in mm

Panel Mounting



- 1) Circumferential sealing (1 x)
- 2) Screw (4 x)
- 3) Position of control panel
- 4) Span piece (4 x)
- 5) Threaded sleeve (4 x)

Cutout

138 x 138 mm (DIN 43700)

Fig.: Panel-mount kit, accessory ZU0738

System Overview

Memosens

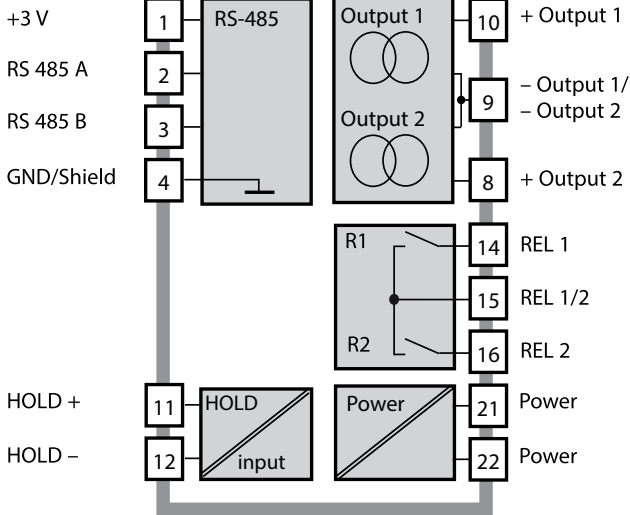

Terminal Assignments, Rating Plates

The terminals are suitable for single or stranded wires up to 2.5 mm² (AWG 14).

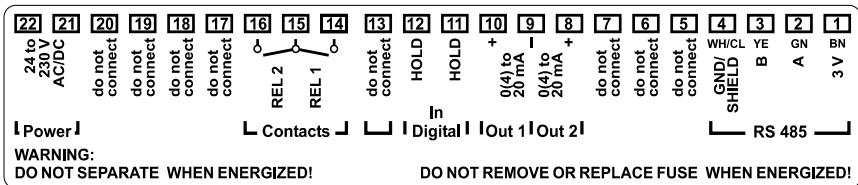

Fig.: Terminal assignments of Stratos MS

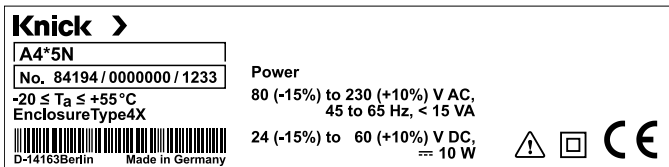
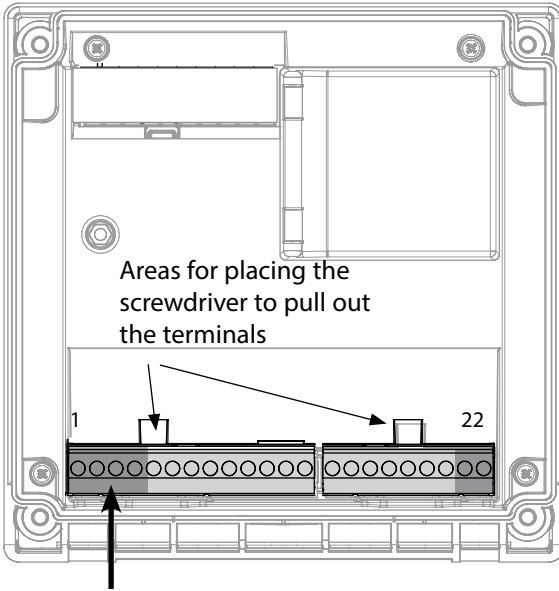

Fig.: Stratos MS rating plate at outside bottom of front (illustrative example)

Electrical Installation

Power Supply

Connect the power supply for Stratos MS to terminals 21 and 22
(80 ... 230 V AC, 45 ... 65 Hz / 24 ... 60 V DC)



Connection of Memosens sensor

1	Brown	+3 V
2	Green	RS 485 A
3	Yellow	RS 485 B
4	White/Transp.	GND/shield

Terminal assignments

Memosens connection

1 (BN)	+3 V	Brown
2 (GN)	RS 485 A	Green
3 (YE)	RS 485 B	Yellow
4 (WH/CL)	GND/ shield	White / Transp.
5	do not connect	
6	do not connect	
7	do not connect	

Current outputs OUT1, OUT2

8	+ Out 2	
9	- Out 1 / Out 2	
10	+ Out 1	
11	HOLD	
12	HOLD	
13	do not connect	

Relay contacts REL1, REL2

14	REL 1	
15	REL 1/2	
16	REL 2	
17	do not connect	
18	do not connect	
19	do not connect	
20	do not connect	

Power supply

21	power	
22	power	

Figure:
Terminals, device opened,
back of front unit

Start-Up

When a Memosens sensor is connected, the appropriate measuring function (device type) is automatically loaded.

Changing the Measuring Function

In the "Service" menu you can select another measuring function at any time.

Calibration and Maintenance in the Lab

The "MemoSuite" software allows calibrating Memosens sensors under reproducible conditions at a PC in the lab. The sensor parameters are registered in a database. Documenting and archiving meet the demands of FDA CFR 21 Part 11. Detailed reports can be output as csv export for Excel. MemoSuite is available as accessory and comes in the versions "Basic" and "Advanced": www.knick.de.

Settings and specifications

Connected sensor: sensor type, manufacturer, order code and serial number

Function selection:
The selected function is highlighted.

Connected sensor: sensor type, manufacturer, order code and serial number, measuring point and tag number

Last adjustment

The screenshot shows the MemoSuite software interface. The top navigation bar includes 'StartCenter', 'Calibration', 'Table View', 'History', 'Statistics', and 'pH Buffers'. The 'pH Buffers' tab is selected. The main area is divided into three sections: 'Measured values' (pH value: 7.09 pH, pH voltage: 49.2 mV, Temperature: 25.1 °C), 'Sensor data' (Sensor type: pH (glass), Manufacturer: KNICK, Order code: SE 533X/1-NMSN, Serial number: 1030550, Measuring point: 0, Tag number: 0), and 'Adjustment data' (Date: 6/27/2011 20:09:12, Slope: 58.5 mV/pH, Zero point: 7.06 pH). A red circle highlights the '7.09 pH' value in the 'Measured values' section. A red box highlights the 'Sensor data' section. A red box highlights the 'Adjustment data' section. A red box highlights the 'pH Buffers' tab in the navigation bar. A red box highlights the '7.09 pH' value in a magnified view at the bottom left. A red arrow points from the magnified view to the '7.09 pH' value in the 'Measured values' section.

pH value

7.09 pH

You can magnify a measured-value display at a click of the mouse.

Measuring Mode

After the operating voltage has been connected, the analyzer automatically goes to “Measuring” mode. To call the measuring mode from another operating mode (e.g., Diagnostics, Service): Hold **meas** key depressed (> 2 s).

Sensoface indicator
(sensor status)

Time

Mode indicator
(measuring)

Hold **meas** key
depressed for calling
the measuring mode
(hitting the key once
more switches the
display)

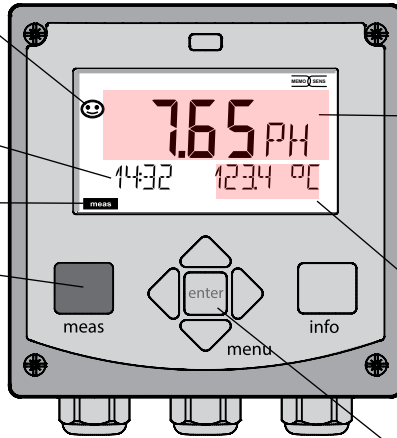

Display indicates
OUT1:
e.g., measured
value

Display indicates
OUT2:
e.g.,
temperature

enter key

Depending on the configuration, you can set various displays as standard display for the measuring mode (see page 20).

Note: By pressing the **meas** key in measuring mode you can view the displays for approx. 60 sec.



You must configure the analyzer for the respective measurement task, see page 28.

The Keys and Their Functions

Up / Down arrows

- Menu: Increase/decrease a numeral
- Menu: Selection

Left / Right arrows

- Menu: Previous/next menu group
- Number entry: Move between digits

meas

- Return to last menu level
- Directly to measuring mode (press > 2 s)
- Measuring mode: other display (temporarily for approx. 60 s)

info

- Retrieve information
- Show error messages

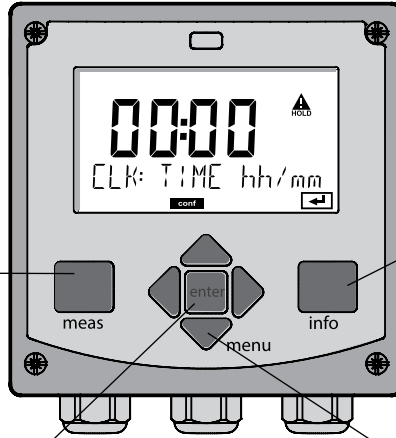

enter



- Configuration: Confirm entries, next configuration step
- Calibration: Continue program flow

menu

- Measuring mode: Call menu

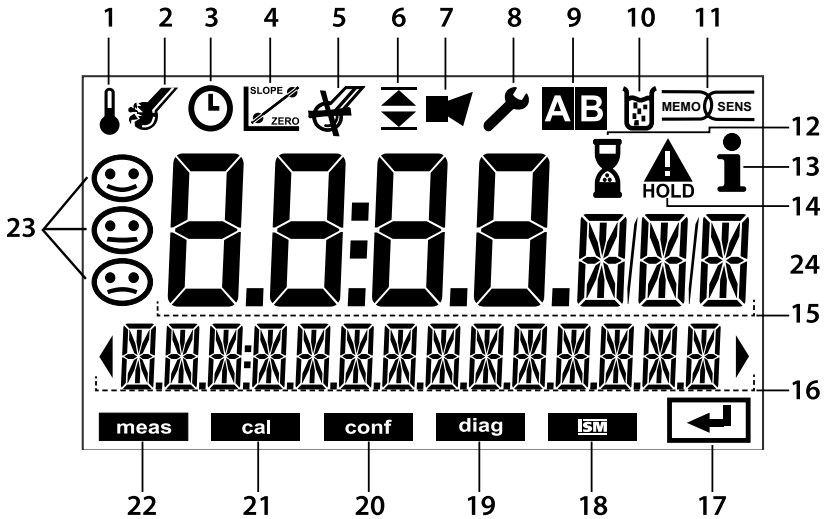
The Display



- | | | | |
|----|--|----|-----------------------|
| 1 | Temperature | 13 | Info available |
| 2 | Sensocheck | 14 | HOLD mode active |
| 3 | Interval/response time | 15 | Primary process value |
| 4 | Sensor data | 16 | Secondary display |
| 5 | Wear | 17 | Proceed using enter |
| 6 | Limit message:
Limit 1  or Limit 2  | 18 | Not used |
| 7 | Alarm | 19 | Diagnostics |
| 8 | Service | 20 | Configuration mode |
| 9 | Not used | 21 | Calibration mode |
| 10 | Calibration | 22 | Measuring mode |
| 11 | Memosens sensor | 23 | Sensoface |
| 12 | Waiting time running | 24 | Unit symbols |

Signal Colors (Display Backlighting)

- | | |
|--------------|--|
| Red | Alarm (in case of fault: display values blink) |
| Red blinking | Input error: illegal value or wrong passcode |

Operation

Display in Measuring Mode

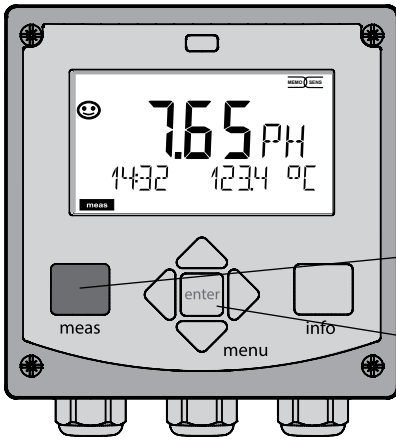

The MAIN DISPLAY is the display which is shown in measuring mode. To call the measuring mode from any other mode, hold the **meas** key depressed for at least 2 sec.

meas key

enter key

meas



meas

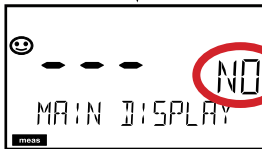

approx. 2 s



By pressing **meas** briefly you can step through further displays such as primary value or tag number (TAG).

After 60 sec they switch back to the main display.

Press **enter** to select a display as MAIN DISPLAY (displayed permanently in measuring mode).

The secondary display shows "MAIN DISPLAY – NO".

Use the **UP / DOWN** arrows to select "MAIN DISPLAY – YES" and confirm by pressing **enter**.

This display is now shown in measuring mode.

To select the operating mode:

- 1) Hold **meas** key depressed (> 2 s) (measuring mode)
- 2) Press **menu** key: the selection menu appears
- 3) Select operating mode using left / right arrow key
- 4) Press **enter** to confirm the selected mode

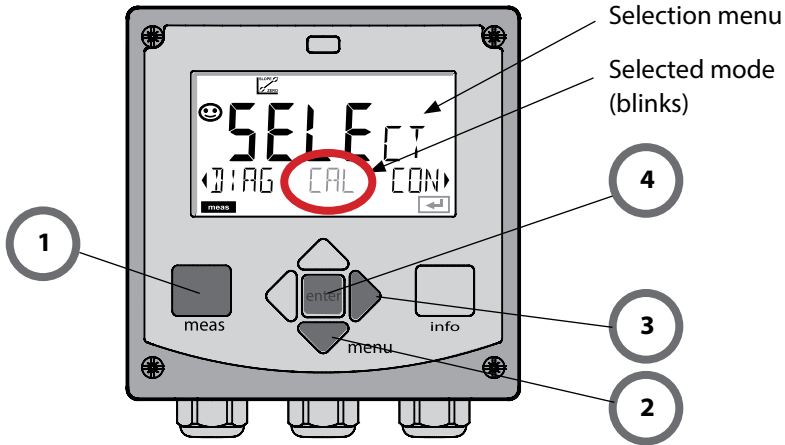

To enter a value:

- 5) Select numeral: left / right arrow
- 6) Change numeral: up / down arrow
- 7) Confirm entry by pressing **enter**

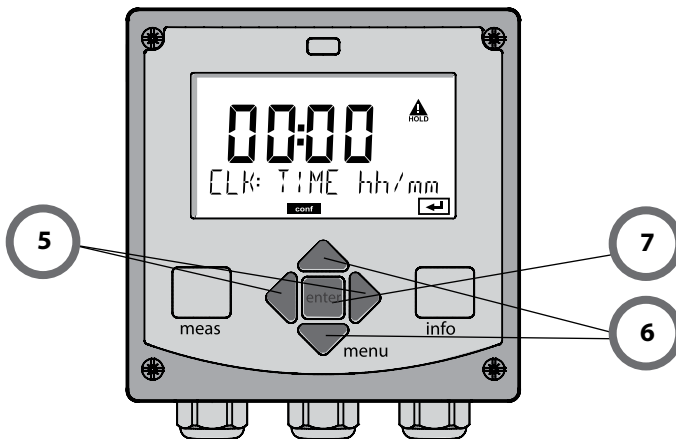

Operating Modes

Diagnostics

Display of calibration data, display of sensor data, sensor monitor, performing a device self-test, viewing the logbook entries, display of hardware/software versions of the individual components. The logbook can store 100 events (00...99). They can be displayed directly on the device.

HOLD

Manual activation of HOLD mode, e.g., for replacing a sensor. The signal outputs adopt a defined state. HOLD can also be activated via the external input (see next page).

Calibration

Every sensor has typical characteristic values, which change in the course of the operating time. Calibration is required to supply a correct measured value. The device checks which value the sensor delivers when measuring in a known solution. When there is a deviation, the device can be "adjusted". In that case, the device displays the "actual" value and internally corrects the measurement error of the sensor. Calibration must be repeated at regular intervals. The time between the calibration cycles depends on the load on the sensor. During calibration the device is in HOLD mode.

During calibration the device remains in the HOLD mode until it is stopped by the operator.

Configuration

You must configure the analyzer for the respective measurement task. In the "Configuration" mode you select the connected sensor, the measuring range to be transmitted, and the conditions for warning and alarm messages. During configuration the device is in HOLD mode.

Configuration mode is automatically exited 20 minutes after the last keystroke. The device returns to measuring mode.

Service

Maintenance functions (current source, relay test), assigning passcodes, selecting the device type (pH/oxy/conductivity), resetting to factory settings.

The HOLD mode is a safety state during configuration and calibration. Output current is frozen (LAST) or set to a fixed value (FIX). Alarm and limit contacts are disabled.

HOLD mode, display icon:



Output signal response

- **LAST:** The output current is frozen at its last value. Recommended for short configuration procedures. The process should not change decisively during configuration. Changes are not noticed with this setting!
- **FIX:** The output current is set to a value that is noticeably different from the process value to signal the control system that the device is being worked at.

Output signal during HOLD:

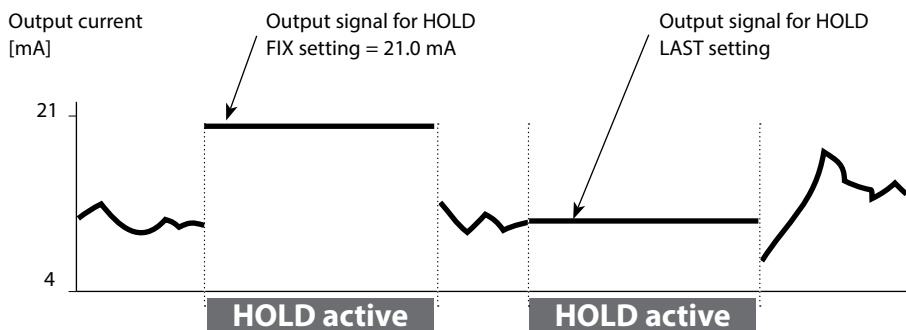

Terminating the HOLD mode

The HOLD mode is exited by switching to measuring mode (hold **meas** key depressed). The display reads "Good Bye". After that, the HOLD mode is exited. When the calibration mode is exited, a confirmation prompt ensures that the installation is ready for operation (e.g.: sensor reinstalled, located in process).

External activation of HOLD

The HOLD mode can be activated from outside by sending a signal to the HOLD input (e.g., from the process control system).

HOLD inactive	0...2 V AC/DC
HOLD active	10...30 V AC/DC

Operating Modes / Functions

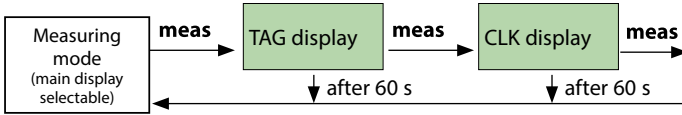

Pressing the **menu** key (down arrow) opens the selection menu.
 Select the menu group using the left/right arrow keys.
 Pressing **enter** opens a menu item. Press **meas** to return.

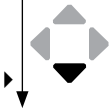

DIAG	CALDATA	Display of calibration data
	SENSOR	Display of sensor data
	SELFTTEST	Self test: RAM, ROM, EEPROM, module
	LOGBOOK	100 events with date and time
	MONITOR	Display of direct sensor values
	VERSION	Display of software version, model designation, serial no.
HOLD	Manual activation of HOLD mode, e.g., for sensor replacement. The signal outputs behave as configured (e.g., last measured value, 21 mA)	
CAL	pH	pH adjustment / ORP adjustment / product calibration
	Oxy	Adjustment (WTR/AIR) / zero adjustment / product cal.
	COND(I)	Adjustment with solution / factor input / product cal.
	CAL_RTDT	Adjustment of temperature probe
CONF	CONF	Configuration See "Overview of Configuration" on next page.
SERVICE <small>(Access via code, factory setting: 5555)</small>	MONITOR	Display of measured values for validation (simulators)
	OUT1	Current source, output 1
	OUT2	Current source, output 2
	RELAIS	Relay test
	CODES	Specifying access codes for operating modes
	DEVICE TYPE	Selecting the device type
	DEFAULT	Reset to factory setting

Menu Structure of Configuration

The configuration steps are assigned to different menu groups.

Using the left/right arrow keys, you can jump between the individual menu groups.

Each menu group contains menu items for setting the parameters.



Pressing **enter** opens a menu item. Use the arrow keys to edit a value.

Press **enter** to confirm/save the settings.

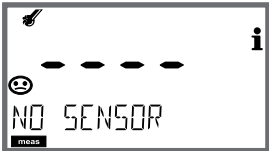

Return to measurement: Hold **meas** key depressed (> 2 s).

Select menu group	Menu group	Code	Display	Select menu item
	Sensor settings	SNS:	Conf SENSOR	 enter enter enter enter
		Menu item 1		
		:		
		Menu item ...		
▶	Current Output 1	OT1:	Conf OUT 1	
▶	Current Output 2	OT2:	Conf OUT 2	
▶	Compensation	COR:	Conf CORRECT:ON	
▶	Alarm mode	ALA:	Conf ALARM	
▶	Relay outputs (LIMIT / ALARM / WASH)	REL:	Conf REL 1/REL 2	
▶	Setting the clock	CLK:	Conf CLOCK	
▶	Tag number	TAG:	Conf TAG	◀

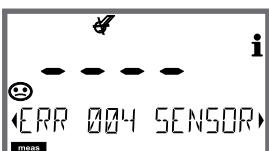
Connecting a Memosens Sensor

Step	Action/Display	Remark
Connect sensor		When no Memosens sensor is connected, the error message "NO SENSOR" is displayed.
Wait until the sensor data are displayed.		The hourglass in the display blinks.
Check sensor data	 <p data-bbox="389 722 658 818">View sensor information using ◀ ▶ keys, confirm using enter.</p>	Sensoface is friendly when the sensor data are okay.
Go to measuring mode	Press meas , info or enter	After 60 sec the device automatically returns to measuring mode (timeout).
Possible error message		
Sensor defective. Replace sensor		When this error message appears, the sensor cannot be used. Sensoface is sad.

Replacing a Sensor

Step	Action/Display	Remark
<p>Select HOLD mode A sensor should only be replaced during HOLD mode to prevent unintended reactions of the outputs or contacts.</p>	<p>Press menu key to call the selection menu, select HOLD using the ◀ ▶ keys, press enter to confirm.</p>	<p>Now the device is in HOLD mode. The HOLD mode can also be activated externally via the HOLD input. During HOLD the output current is frozen at its last value or set to a fixed value.</p>
<p>Disconnect and remove old sensor</p>		
<p>Install and connect new sensor.</p>		<p>Temporary messages which are activated during the replacement are indicated but not output to the alarm contact and not entered in the logbook.</p>
<p>Wait until the sensor data are displayed.</p>		
<p>Check sensor data</p>	 <p>View sensor information using ◀ ▶ keys, confirm using enter.</p>	<p>You can view the sensor manufacturer and type, serial number and last calibration date.</p>
<p>Check measured values</p>		
<p>EXIT HOLD</p>	<p>Hit meas key: Return to the selection menu. Hold meas key depressed: Device switches to measuring mode.</p>	

Configuration

⚠ CAUTION! Incorrect parameter settings or adjustments can result in incorrect outputs. Stratos MS must therefore be commissioned by a system specialist, all its parameters must be set, and it must be fully adjusted. For detailed information on parameter setting and adjustment, see the user manual

Configuration: Overview

Configuration (default in bold print)			
Sensor		pH	
SNS	TEMP UNIT	°C / °F	
	CALMODE		AUTO / MAN / DAT
	AUTO	BUFFER SET	-01- MT -02- KNC ... -U1- USR ("info" shows nominal buffer values)
	CALTIMER		OFF / ON
	ON	CAL-CYCLE	0 ... 9999 h (168 h)
	CHECK TAG		OFF / ON
	CHECK GROUP		OFF / ON

Configuration: Overview

Current output 1			pH
OT1	RANGE		4 ... 20 mA / 0 ... 20 mA
	CHANNEL		PH / ORP / TEMP
	PH	BEGIN (0)4 mA	00.00 pH / -2.00 ... 16.00 pH
		END 20 mA	14.00 pH / -2.00 ... 16.00 pH
	rH	BEGIN (0)4 mA	000.0 rH / 000.0 ... 200.0 rH
		END 20 mA	200.0 rH / 000.0 ... 200.0 rH
	ORP (Memosens ORP sensor)	BEGIN (0)4 mA	-1000 mV / -1999 ... 1999 mV
		END 20 mA	1000 mV / -1999 ... 1999 mV
	TMP °C	BEGIN (0)4 mA	000.0 °C / -20 ... 300 °C
		END 20 mA	100.0 °C / -20 ... 300 °C
	TMP °F	BEGIN (0)4 mA	032.0 °F / -4 ... 572 °F
		END 20 mA	212.0 °F / -4 ... 572 °F
	FILTERTIME		0000 SEC / 0 ... 120 SEC
	FAIL 22 mA		OFF / ON
	FACE 22mA		OFF / ON
HOLD MODE		LAST / FIX	
FIX	HOLD_FIX	021.0 mA / 0 ... 22 mA	
Current output 2			Default setting CHANNEL: TMP (other settings like OT1)

Correction			pH
COR	TC SELECT		OFF / LIN / PURE WTR
	LIN	TC LIQUID	00.00 %/K / -19.99 ... 19.99 %/K

Configuration: Overview

Configuration (default in bold print)		
Alarm		pH
ALA	DELAYTIME	0 ... 600 s (0010 SEC)
	SENSOCHECK	ON / OFF
Relay 1		
RL1	LIMIT ALARM WASH	The following submenu depends on the selected setting.
LM1	CHANNEL	PH / ORP / TMP
	FUNCTION	Lo LEVEL / Hi LEVEL
	CONTACT	N/O / N/C
	LEVEL	00.00 pH -2.00 ... 16.00 pH (-1999 ... 1999 mV) (-20 ... 200 °C)
	HYSTERESIS	00.50 pH 0.00 ... 10.00 pH / 0 ... 2000 mV / 0 ... 100 °C (0 ... 180 °F)
	DELAYTIME	0010 SEC 0000 ... 9999 s
AL1	TRIGGER	FAIL / FACE
	CONTACT	N/O / N/C
WS1	CYCLE TIME	000.0 h 0.0 ... 999.9 h
	DURATION	0060 SEC 0 ... 1999 s
	RELAX TIME	0030 SEC / 0000 ... 1999 s
	CONTACT	N/O / N/C
Relay 2 Default LIMIT / FUNCTION: Hi LEVEL (other settings like Relay 1)		

Configuration: Overview

Time/date			
CLK	FORMAT	24 h / 12 h	
	24 h	hh:mm	
	12 h	hh:mm (AM / PM)	00 ... 12:59 AM / 1 ... 11:59 PM
	DAY / MONTH	dd.mm	
	YEAR	2000 ... 2099	
Measuring points (TAG / GROUP)			
TAG	The entries are made in the text line.	A...Z, 0...9, - + < > ? / @	
GROUP	The entries are made in the text line.	0000...9999 (0000)	

Configuring the Sensor

Device Type: pH



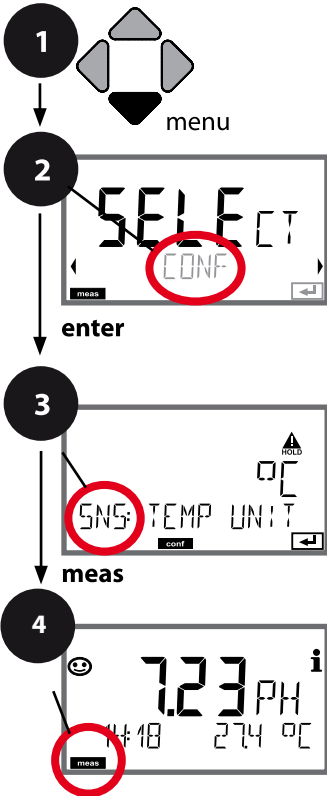

The device type is automatically selected upon first start-up. In the SERVICE menu you can change the device type. Afterwards, you must select the corresponding calibration mode in the CONF menu.



- 1 Press **menu**.
- 2 Select **CONF** using ◀ ▶, press **enter**.
- 3 Select **SENSOR** menu using ◀ ▶ keys, press **enter**.
All items of this menu group are indicated by the "SNS:" code.
Press **enter** to select menu, edit using arrow keys (see next page). Confirm (and proceed) by pressing **enter**.
- 4 Exit: Press **meas** key until the [meas] mode indicator is displayed.

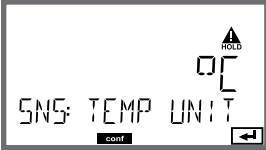



Temperature unit	enter
Calibration mode	enter
(Auto: Buffer set)	enter
Calibration timer	
Calibration cycle	
CHECK TAG	
CHECK GROUP	

Configuring the Sensor

Menu item	Action	Choices
<p>Temperature unit</p> 	<p>Select °C or °F using ▲ ▼ keys.</p> <p>Press enter to confirm.</p>	°C / °F
<p>Calibration mode</p> 	<p>Select CALMODE using ▲ ▼ keys:</p> <p>AUTO: Calibration with Calimatic buffer set recognition</p> <p>MAN: Manual input of buffer solutions</p> <p>DAT: Input of adjustment data of premeasured sensors</p> <p>Press enter to confirm.</p>	<p>AUTO</p> <p>MAN</p> <p>DAT</p>
<p>(AUTO: Buffer set)</p> 	<p>Select buffer set using ▲ ▼ keys (see buffer tables for nominal values)</p> <p>Press enter to confirm.</p>	<p>-01-...-13-, -U1- USR (see Appendix)</p> <p>Pressing the info key displays the manufacturer and nominal values in the lower line.</p>
<p>Calibration timer</p> 	<p>Adjust CALTIMER using ▲ ▼ :</p> <p>OFF: No timer</p> <p>ON: Fixed cal cycle (adjust in the next step)</p> <p>Press enter to confirm.</p>	<p>OFF / ON</p> <p>(ON: 0 ... 9999 h)</p>

Note for the calibration timer:

When Sensocheck has been activated in the Configuration > Alarm menu, the expiration of the calibration interval is indicated by Sensoface:

	+		Over 80 % of the calibration interval has already passed.
	+		The calibration interval has been exceeded.

The time remaining until the next due calibration can be seen in the diagnostics menu (see Diagnostics chapter).

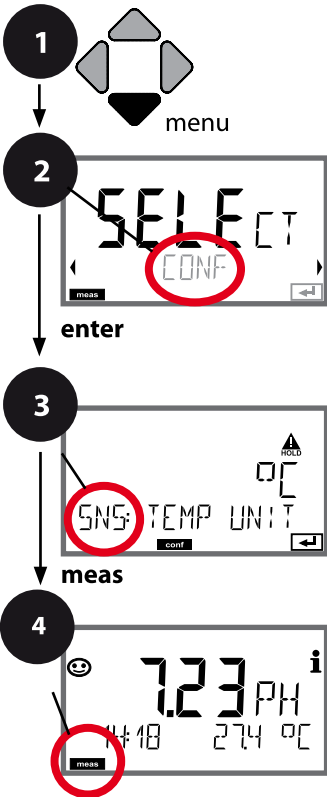

Configuring the Sensor

Sensor Verification (TAG, GROUP)

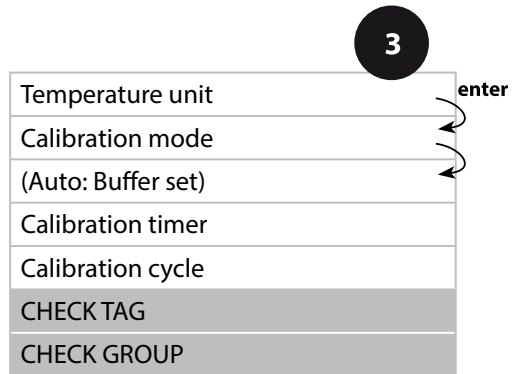

- 1 Press **menu** key.
- 2 Select **CONF** using ◀ ▶, press **enter**.
- 3 Select **SENSOR** menu using ◀ ▶ keys, press **enter**.
All items of this menu group are indicated by the "SNS:" code.
Press **enter** to select menu, edit using arrow keys (see next page).
Confirm (and proceed) by pressing **enter**.
- 4 Exit: Press **meas** key until the [meas] mode indicator is displayed.



Menu item	Action	Choices
<p>TAG</p> 	<p>Select ON or OFF using ▲ ▼ keys. Press enter to confirm.</p> <p>When switched on, the entry for "TAG" in the Memosens sensor is compared to the entry in the analyzer. If the entries differ, a message will be generated.</p>	ON/OFF
<p>GROUP</p> 	<p>Select ON or OFF using ▲ ▼ keys. Press enter to confirm.</p> <p>Function as described above</p>	ON/OFF

Sensor Verification (TAG, GROUP)

When Memosens sensors are calibrated in the lab, it is often useful and sometimes even mandatory that these sensors will be operated again at the same measuring points or at a defined group of measuring points. To ensure this, you can save the respective measuring point (TAG) or group of measuring points (GROUP) in the sensor. TAG and GROUP can be specified by the calibration tool or automatically entered by the transmitter. When connecting an MS sensor to the transmitter, it can be checked if the sensor contains the correct TAG or belongs to the correct GROUP. If not, a message will be generated and Sensoface gets "sad". The "sad" Sensoface icon can also be signaled by a 22 mA error current. Sensor verification can be switched on in the Configuration in two steps as TAG and GROUP if required.

When no measuring point or group of measuring points is saved in the sensor, e.g., when using a new sensor, Stratos enters its own TAG and GROUP. When sensor verification is switched off, Stratos always enters its own measuring point and group. A possibly existing TAG/GROUP will be overwritten.

Configuring the Current Output

Output Current: Range, Current Start/End



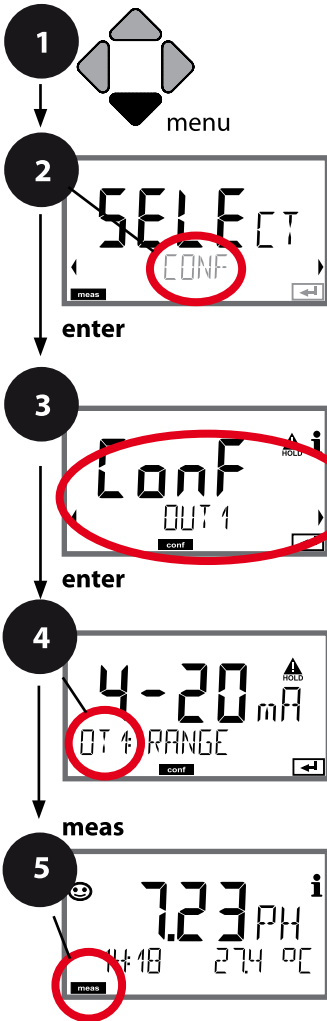

(Example: current output 1)



- 1 Press **menu** key.
- 2 Select **CONF** using **◀ ▶**, press **enter**.
- 3 Select **OUT1** menu using **◀ ▶** keys, press **enter**.
- 4 All items of this menu group are indicated by the "OT1:" code.
Press **enter** to select menu, edit using arrow keys (see next page). Confirm (and proceed) by pressing **enter**.
- 5 Exit: Press **meas** key until the [meas] mode indicator is displayed.

4	Current range	enter
	Process variable	enter
	Current start	enter
	Current end	
	Time averaging filter	
	Output current during error message	
	Output current for Sensoface message	
	Output current during HOLD	
	Output current for HOLD FIX	

Configuring the Current Output

Menu item	Action	Choices
<p>Current range</p> 	<p>Select 4-20 mA or 0-20 mA range using \blacktriangle \blacktriangledown keys.</p> <p>Press enter to confirm.</p>	<p>4-20 mA / 0-20 mA</p>
<p>Process variable</p> 	<p>Example: current output 1, device type pH</p> <p>Select using \blacktriangle \blacktriangledown keys:</p> <p>PH: pH value ORP: ORP value TMP: Temperature</p> <p>Press enter to confirm.</p>	<p>PH/ORP/TMP</p>
<p>Current start</p> 	<p>Modify digit using \blacktriangle \blacktriangledown keys, select next digit using \blacktriangleleft \blacktriangleright keys.</p> <p>Press enter to confirm.</p>	<p>-2.00 ... 16.00 pH (PH) -1999 ... 1999 mV (ORP) -20 ... 300 °C / -4 ... 572 °F (TMP)</p>
<p>Current end</p> 	<p>Enter value using \blacktriangle \blacktriangledown \blacktriangleleft \blacktriangleright keys.</p> <p>Press enter to confirm.</p>	<p>-2.00 ... 16.00 pH (PH) -1999 ... 1999 mV (ORP) -20 ... 300 °C / -4 ... 572 °F (TMP)</p>

Assignment of measured values: Current start and current end

Example 1: Range pH 0...14

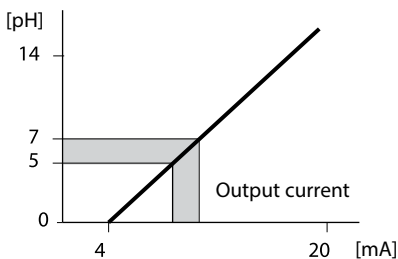

Example 2: Range pH 5...7

Advantage: Higher resolution in range of interest

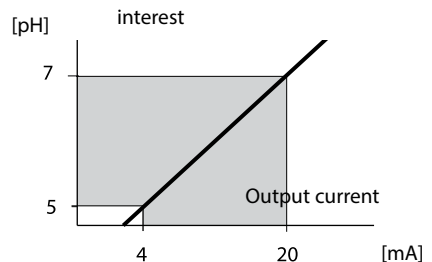

Configuring the Current Output

Output Current: Time Averaging Filter

(Example: current output 1)



- 1 Press **menu** key.
- 2 Select **CONF** using ◀ ▶, press **enter**.
- 3 Select **OUT1** menu using ◀ ▶ keys, press **enter**.
- 4 All items of this menu group are indicated by the "OT1:" code. Press **enter** to select menu, edit using arrow keys (see next page). Confirm (and proceed) by pressing **enter**.
- 5 Exit: Press **meas** key until the [meas] mode indicator is displayed.

Current range	enter
Process variable	
Current start	enter
Current end	enter
Time averaging filter	
Output current during error message	
Output current for Sensoface message	
Output current during HOLD	
Output current for HOLD FIX	

Configuring the Current Output

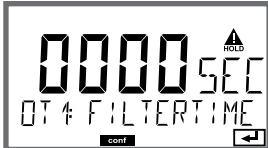
Menu item	Action	Choices
Time averaging filter 	Enter value using ▲ ▼ ◀ ▶ keys. Press enter to confirm.	0...120 SEC (0000 SEC)

Time averaging filter

To smoothen the current output, a low-pass filter with adjustable filter time constant can be switched on. When there is a jump at the input (100 %), the output level is at 63 % after the time interval has been reached. The time interval can be set from 0 to 120 sec. If the time interval is set to 0 sec, the current output directly follows the input.

Note:

The filter only acts on the current output, not on the display or the limit values! During HOLD the filter is not applied. This prevents a jump at the output.

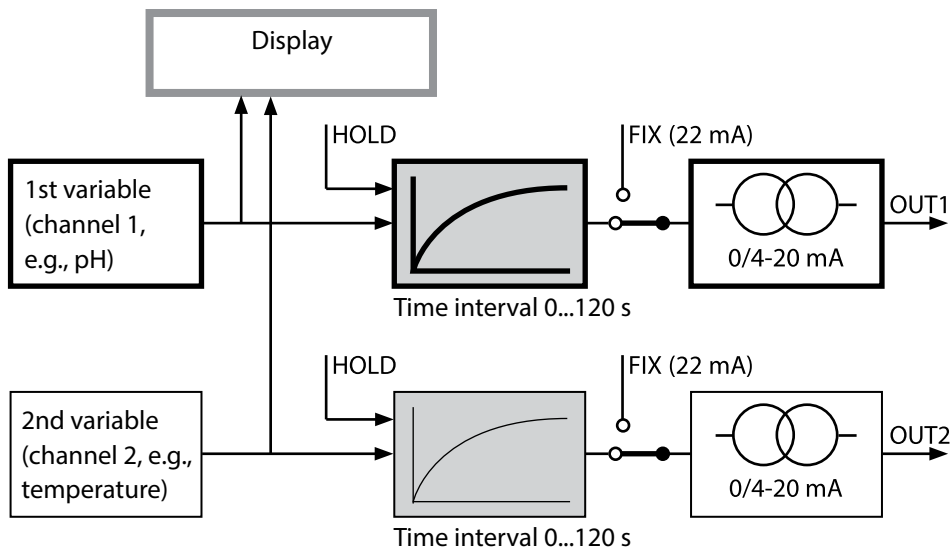

Configuring the Current Output

Output Current: Error and HOLD

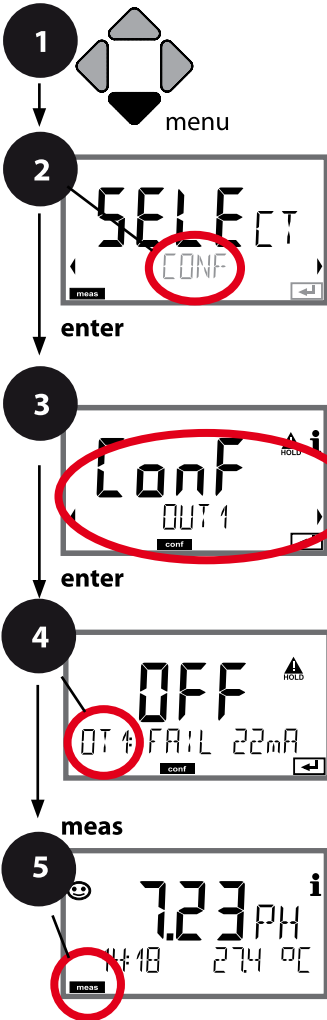

(Example: current output 1)



- 1 Press **menu** key.
- 2 Select **CONF** using ◀ ▶, press **enter**.
- 3 Select **OUT1** menu using ◀ ▶ keys, press **enter**.
- 4 All items of this menu group are indicated by the "OT1:" code. Press **enter** to select menu, edit using arrow keys (see next page). Confirm (and proceed) by pressing **enter**.
- 5 Exit: Press **meas** key until the [meas] mode indicator is displayed.

Current range
Process variable
Current start
Current end
Time averaging filter
Output current during error message
Output current for Sensoface message
Output current during HOLD
Output current for HOLD FIX

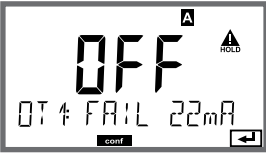
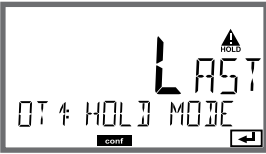
Configuring the Current Output

Menu item	Action	Choices
Output current during error message 	The output current can be set to 22 mA in the case of error messages or error messages. Select ON or OFF using ▲ ▼ keys. Confirm by pressing enter	OFF / ON
Output current during Sensoface messages OT1: FACE 22 mA	The output current can be set to 22 mA in the case of Sensoface messages. Select ON or OFF using ▲ ▼ keys. Confirm by pressing enter	OFF / ON
Output current during HOLD 	LAST: During HOLD the last measured value is maintained at the output. FIX: During HOLD a value (to be entered) is maintained at the output. Select using ▲ ▼ Press enter to confirm.	LAST/FIX
Output current for HOLD FIX 	Only with FIX selected: Enter current which is to flow at the output during HOLD Enter value using ▲ ▼ ◀ ▶ keys. Press enter to confirm.	00.00...22.00 mA (21.00 mA)

Output signal during HOLD:

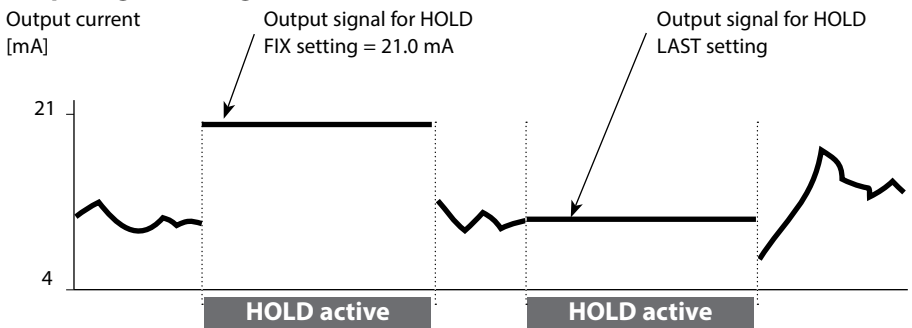

Configuring the Alarm

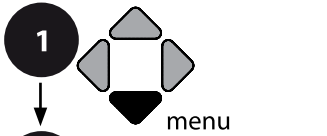

Alarm Delay, Sensocheck



- 1 Press **menu** key.
- 2 Select **CONF** using ◀ ▶, press **enter**.
- 3 Select **ALARM** menu using ◀ ▶ keys, press **enter**.
- 4 All items of this menu group are indicated by the "ALA:" code. Press **enter** to select menu, edit using arrow keys (see next page). Confirm (and proceed) by pressing **enter**.
- 5 Exit: Press **meas** key until the [meas] mode indicator is displayed.



Configuring the Alarm

Menu item	Action	Choices
<p>Alarm delay</p> 	<p>Enter value using ▲ ▼ ◀ ▶ keys. Press enter to confirm.</p>	<p>0...600 SEC (0010 SEC)</p>
<p>Sensocheck</p> 	<p>Select Sensocheck (continuous monitoring of glass and reference electrode). Select ON or OFF using ▲ ▼ keys. Press enter to confirm. (At the same time, Sensoface is activated. With OFF, Sensoface is also switched off.)</p>	<p>ON / OFF</p>

The alarm delay time delays the color change of the display backlighting to red, the 22 mA signal (if configured), and the alarm contact switching.

Error messages can be signaled by a 22 mA output current. In addition, a relay contact (RELAY1 / RELAY2) can be configured as alarm contact.

Temperature Compensation

Temperature Compensation of Process Medium (pH)

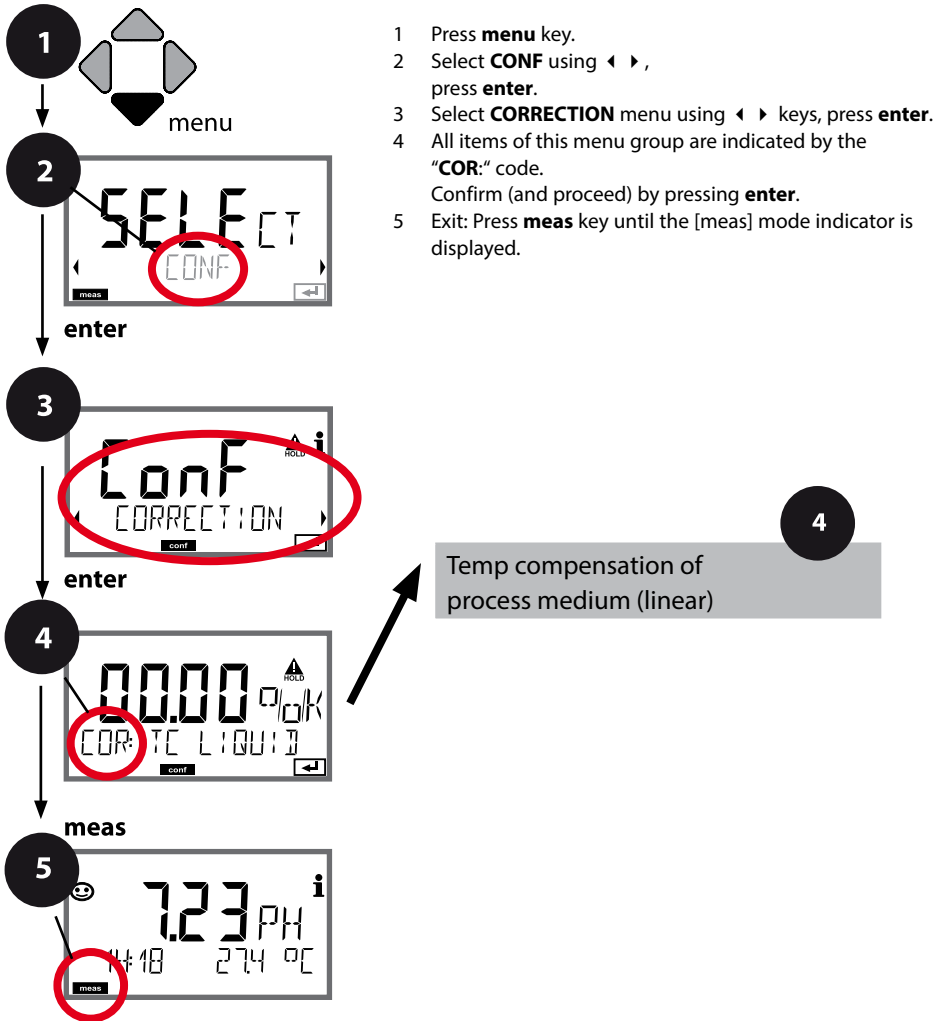

Temperature Compensation

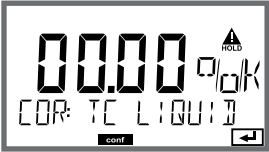
Menu item	Action	Choices
<p>Temperature compensa- tion of process medium</p> 	<p>For pH measurement only: Select temperature compensa- tion of the process medium. Linear: LIN Select using ◀ ▶ , press enter to confirm.</p>	<p>OFF / LIN</p>
<p>Temperature compensa- tion, linear</p> 	<p>Enter the linear temperature compensation of the process medium. Enter value using ▲ ▼ ◀ ▶ keys Press enter to confirm.</p>	<p>-19.99...+19.99 %/K</p>

Configuring the Relay Contacts





Relay Contacts: Function Assignment, Limit Values

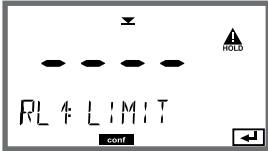

- 1 Press **menu** key.
- 2 Select **CONF** using ◀ ▶, press **enter**.
- 3 Select **RELAY1** menu using ◀ ▶ keys, press **enter**.
Specify relay contact function: **LIMIT**.
- 4 All items of this menu group are indicated by the "LM1:" code.
Press **enter** to select menu, edit using arrow keys (see next page).
Confirm (and proceed) by pressing **enter**.
- 5 Exit: Press **meas** key until the [meas] mode indicator is displayed.

Use of relays	4	enter
Select process variable		
Limit 1 switching characteristics (function)		
Limit 1 contact type		
Limit 1 setpoint		
Limit 1 hysteresis		
Limit 1 delay		

Configuring the Relay Contacts

Menu item	Action	Choices
<p>Use of relays</p> 	<p>Select in the text line using ▲ ▼ keys:</p> <ul style="list-style-type: none"> • Limit function (LIMITS) • Error message (ALARM) • Rinse contact (WASH) <p>Press enter to confirm.</p>	<p>LIMIT / ALARM / WASH</p> <p>Note: The following submenu depends on the selected setting.</p>
<p>Select process variable</p> 	<p>Select desired process variable using ▲ ▼ keys.</p> <p>Press enter to confirm.</p>	<p>PH/ORP/TMP</p>
<p>Limit 1 function</p> 	<p>Select desired function using arrow keys.</p> <p>LoLevel: active if value falls below setpoint HiLevel: active if value exceeds setpoint</p> <p>Press enter to confirm.</p>	<p>Lo LEVEL / Hi LEVEL Limit 1 icon: ▼</p>
<p>Limit 1 contact response</p> 	<p>N/O: normally open contact N/C: normally closed contact</p> <p>Select using ▲ ▼ keys.</p> <p>Press enter to confirm.</p>	<p>N/O / N/C</p>
<p>Limit 1 setpoint</p> 	<p>Enter setpoint using ▲ ▼ ◀ ▶ keys.</p> <p>Press enter to confirm.</p>	<p>-2.00 ... 16.00 pH (00.00 pH) -1999 ... 1999 mV / -20 ... 200 °C</p>

Configuring the Relay Contacts

Relay Contacts: Limit Function, Hysteresis

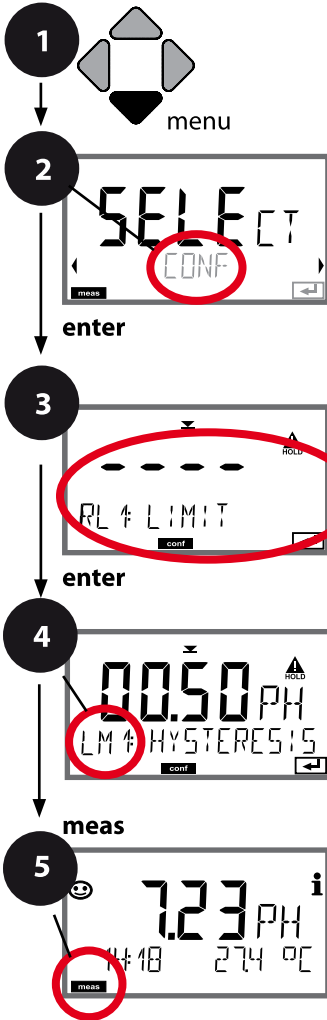

(Example: relay 1)



- 1 Press **menu** key.
- 2 Select **CONF** using ◀ ▶, press **enter**.
- 3 Select **RELAY1** menu using ◀ ▶ keys, press **enter**.
Specify relay contact function: **LIMIT**.
- 4 All items of this menu group are indicated by the "LM1:" code.
Press **enter** to select menu, edit using arrow keys (see next page).
Confirm (and proceed) by pressing **enter**.
- 5 Exit: Press **meas** key until the [meas] mode indicator is displayed.

4	Use of relays	enter
	Select process variable	enter
	Limit 1	enter
	Limit 1 switching characteristics (function)	
	Limit 1 contact type	
	Limit 1 setpoint	
	Limit 1 hysteresis	
	Limit 1 delay	

Configuring the Relay Contacts

Menu item	Action	Choices
Limit 1 hysteresis 	Select hysteresis using \blacktriangle \blacktriangledown \blacktriangleleft \blacktriangleright keys. Press enter to confirm.	0 ... 10.00 pH (00.50 pH)
Limit 1 delay 	The contact is activated with delay (deactivated without delay) Adjust delay using \blacktriangle \blacktriangledown \blacktriangleleft \blacktriangleright keys. Press enter to confirm.	0 ... 9999 SEC (0010 SEC)

Application of hysteresis:

Limit Lo

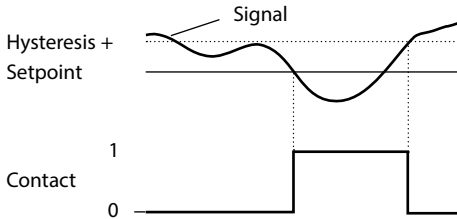

Limit Hi

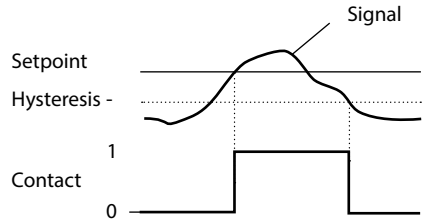

Configuring the Relay Contacts

Relay Contacts: Alarm

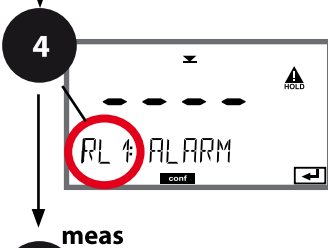
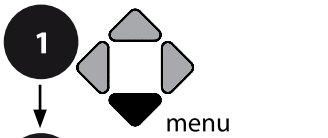

(Example: relay 1)



- 1 Press **menu** key.
- 2 Select **CONF** using ◀ ▶, press **enter**.
- 3 Select **RELAY1** menu using ◀ ▶ keys, press **enter**.
Specify relay contact function: **ALARM**.
- 4 All items of this menu group are indicated by the "AL1:" code.
Press **enter** to select menu, edit using arrow keys (see next page).
Confirm (and proceed) by pressing **enter**.
- 5 Exit: Press **meas** key until the [meas] mode indicator is displayed.



Configuring the Relay Contacts

Menu item	Action	Choices
<p>Alarm</p> 	<p>Select error messages (FAIL) or Sensoface messages (FACE) as trigger signal using ▲ ▼ ◀ ▶ keys. Press enter to confirm.</p>	<p>FAIL / FACE</p>
<p>Contact response</p> 	<p>N/O: normally open contact N/C: normally closed contact Select using ▲ ▼ keys. Press enter to confirm.</p>	<p>N/O / N/C</p>

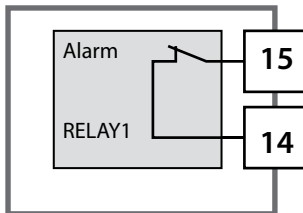

Alarm contact

A relay contact (RELAY1 / RELAY2) can be configured as alarm contact.

Configuring the Relay Contacts

Relay Contacts: Controlling a Rinsing Probe





(Example: relay 1)

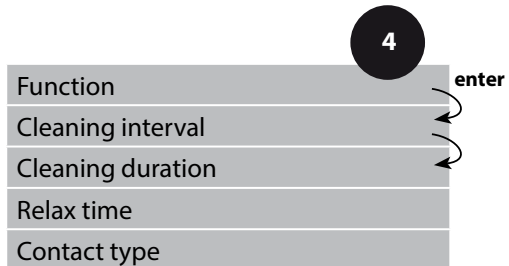

- 1 Press **menu** key.
- 2 Select **CONF** using ◀ ▶, press **enter**.
- 3 Select **RELAY1** menu using ◀ ▶ keys, press **enter**.
Specify relay contact function: **WASH**.
- 4 All items of this menu group are indicated by the "WS1:" code.
Press **enter** to select menu, edit using arrow keys (see next page). Confirm (and proceed) by pressing **enter**.
- 5 Exit: Press **meas** key until the [meas] mode indicator is displayed.

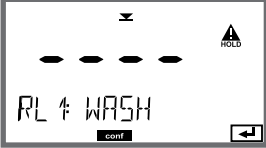

Configuring the Relay Contacts

Menu item	Action	Choices
<p>Use of relays</p> 	<p>Select in the text line using ▲ ▼ keys:</p> <ul style="list-style-type: none"> • Limit function (LIMITS) • Error message (ALARM) • Rinse contact (WASH) <p>Press enter to confirm.</p>	<p>LIMIT / ALARM / WASH</p> <p>Note: The following submenu depends on the selected setting.</p>
<p>Cleaning interval</p> 	<p>Adjust value using ▲ ▼ ◀ ▶ keys.</p> <p>Press enter to confirm.</p>	<p>0.0...999.9 h (000.0 h)</p>
<p>Cleaning duration</p> 	<p>Adjust value using ▲ ▼ ◀ ▶ keys.</p> <p>Press enter to confirm.</p> <p>Without figure: Relax time</p>	<p>0...9999 SEC (0060 SEC)</p> <p>Relax time: 0000...1999 SEC (0030 SEC)</p>
<p>Contact type</p> 	<p>N/O: normally open contact N/C: normally closed contact</p> <p>Select using ▲ ▼ keys.</p> <p>Press enter to confirm.</p>	<p>N/O / N/C</p>

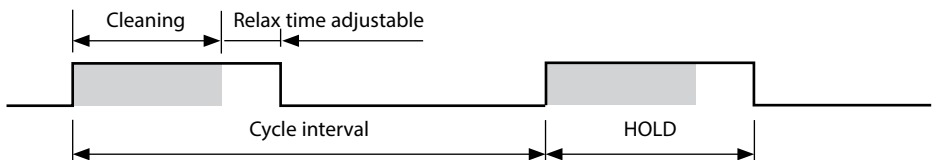

Protective Wiring of Relay Contacts

Relay contacts are subject to electrical erosion. Especially with inductive and capacitive loads, the service life of the contacts will be reduced. For suppression of sparks and arcing, components such as RC combinations, nonlinear resistors, series resistors and diodes should be used.

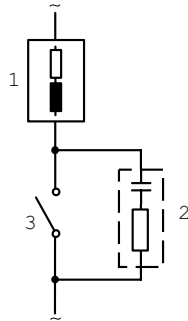
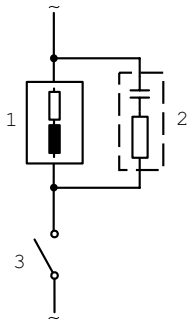

Typical AC applications with inductive load

- 1 Load
- 2 RC combination, e.g., RIFA PMR 209
Typical RC combinations for 230 V AC:
capacitor 0.1 μF / 630 V,
resistor 100 Ω / 1 W
- 3 Contact

Protective Wiring of Relay Contacts

Typical Protective Wiring Measures

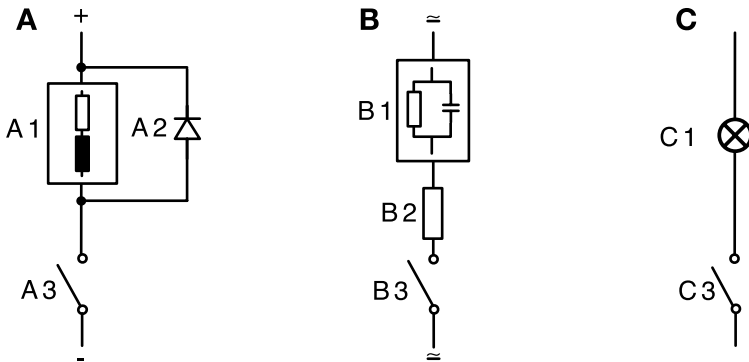

A: DC application with inductive load

B: AC/DC applications with capacitive load

C: Connection of incandescent lamps

A1 Inductive load

A2 Free-wheeling diode, e.g., 1N4007 (Observe polarity)

A3 Contact

B1 Capacitive load

B1 Resistor, e.g., $8\ \Omega / 1\ \text{W}$ at $24\ \text{V} / 0.3\ \text{A}$

B3 Contact

C1 Incandescent lamp, max $60\ \text{W} / 230\ \text{V}$, $30\ \text{W} / 115\ \text{V}$

C3 Contact

NOTICE! Make sure that the maximum ratings of the relay contacts are not exceeded even during switching, see page 89.

Configuring the Time/Date

Time and Date, Measuring Point

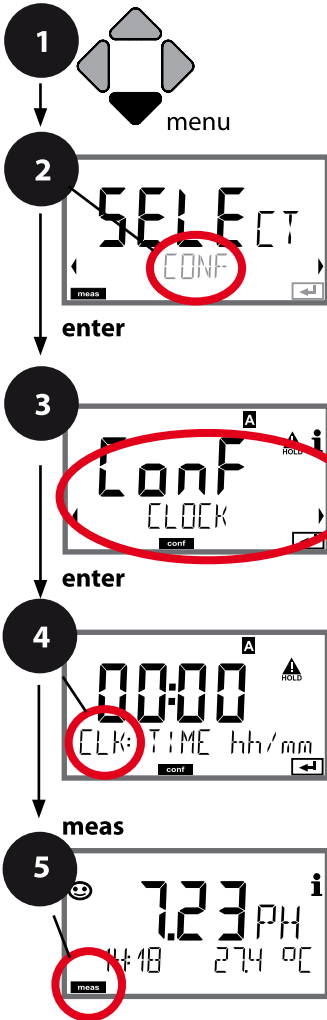

- 1 Press **menu** key.
- 2 Select **CONF** using ◀ ▶, press **enter**.
- 3 Select **CLOCK** or **TAG** using ◀ ▶ keys, press **enter**.
- 4 All items of this menu group are indicated by the "CLK:" or "TAG" code.
Press **enter** to select menu, edit using arrow keys (see next page). Confirm (and proceed) by pressing **enter**.
- 5 Exit: Press **meas** key until the [meas] mode indicator is displayed.

Time format	4	enter
Time		enter
Day and month		enter
Year		
TAG of measuring point		
GROUP of measuring points		

Time and Date

Control of the calibration and cleaning cycles is based on the time and date of the integrated real-time clock.

In measuring mode the time is shown in the lower display. When using digital sensors, the calibration data is written in the sensor head. In addition, the logbook entries (cf Diagnostics) are provided with a time stamp.

Note:

There is no automatic switchover from winter to summer time!
Be sure to manually adjust the time!

Sensor Verification (TAG, GROUP)

When Memosens sensors are calibrated in the lab, it is often useful and sometimes even mandatory that these sensors will be operated again at the same measuring points or at a defined group of measuring points. To ensure this, you can save the respective measuring point (TAG) or group of measuring points (GROUP) in the sensor. TAG and GROUP can be specified by the calibration tool or automatically entered by the transmitter. When connecting an MS sensor to the transmitter, it can be checked if the sensor contains the correct TAG or belongs to the correct GROUP. If not, a message will be generated and Sensoface gets "sad". The "sad" Sensoface icon can also be signaled by a 22 mA error current. Sensor verification can be switched on in the Configuration in two steps as TAG and GROUP if required.

When no measuring point or group of measuring points is saved in the sensor, e.g., when using a new sensor, Stratos enters its own TAG and GROUP. When sensor verification is switched off, Stratos always enters its own measuring point and group. A possibly existing TAG/GROUP will be overwritten.

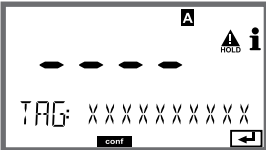
Menu item	Action	Choices
<p>TAG of measuring point</p> 	<p>In the lower display line you can enter a designation for the measuring point (TAG) and for a group of measuring points (GROUP) if applicable. Up to 32 digits are possible. By pressing meas (repeatedly) in the measuring mode you can view the tag number. Select character using ▲ ▼ keys, select next digit using ◀ ▶ keys. Press enter to confirm.</p>	<p>A...Z, 0...9, - + < > ? / @</p> <p>The first 10 characters are seen in the display without scrolling.</p>
<p>GROUP of measuring points</p>	<p>Select number using ▲ ▼ keys, select next digit using ◀ ▶ keys. Confirm by pressing enter</p>	<p>0000 ... 9999 (0000)</p>

Calibration

Note:

- All calibration procedures must be performed by trained personnel. Incorrectly set parameters may go unnoticed, but change the measuring properties.
- The response time of the sensor and temperature probe is considerably reduced when the sensor is first moved about in the buffer solution and then held still.
- The device can only operate properly when the buffer solutions used correspond to the configured set. Other buffer solutions, even those with the same nominal values, may demonstrate a different temperature response. This leads to measurement errors.

Calibration is used to adapt the device to the individual sensor characteristics, namely asymmetry potential and slope.

Access to calibration can be protected with a passcode (SERVICE menu).

First, you open the calibration menu and select the calibration mode:

CAL_PH	Depending on configuration setting: AUTO Automatic buffer recognition (Calimatic) MAN Manual buffer input DAT Input of premeasured electrode data
CAL_ORP	ORP calibration
P_CAL	Product calibration (calibration with sampling)
CAL_RTD	Temperature probe adjustment



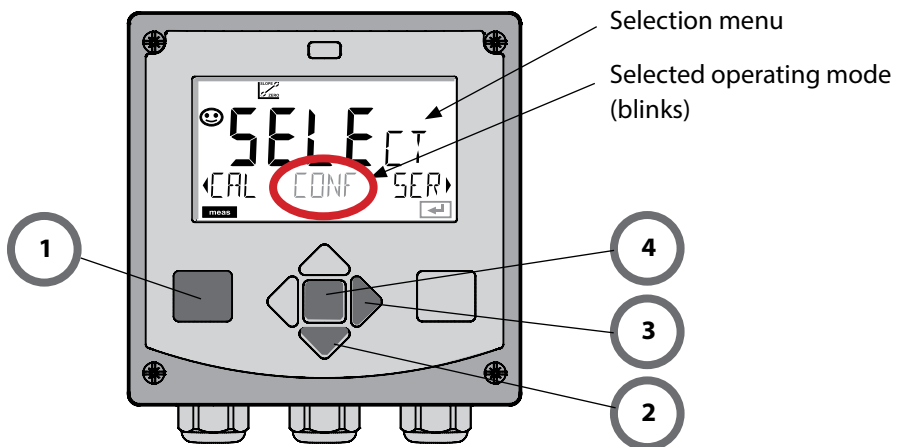

To preset CAL_PH (CONF menu / configuration):







- 1) Hold **meas** key depressed (> 2 s) (measuring mode)
- 2) Press **menu** key: the selection menu appears
- 3) Select CONF mode using left / right arrow key
- 4) Select "SENSOR" – "CALMODE": AUTO, MAN, or DAT.
Press **enter** to confirm.

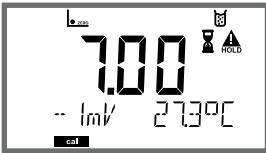

Automatic Calibration

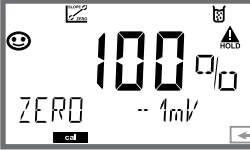

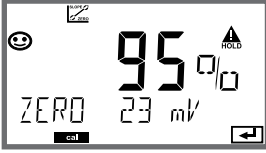

The AUTO calibration mode must have been preset during **configuration**. Make sure that the buffer solutions used correspond to the configured buffer set. Other buffer solutions, even those with the same nominal values, may demonstrate a different temperature response. This leads to measurement errors.





Display	Action	Remark
	Select Calibration. Press enter to proceed.	
	Ready for calibration. Hourglass blinks. Select calibration method: CAL_PH Press enter to proceed.	Display (3 sec) Now the device is in HOLD mode.
	Remove the sensor, clean it, and immerse it in the first buffer solution (it does not matter which solution is taken first). Press enter to start.	
	Buffer recognition. While the "hourglass" icon is blinking, the sensor remains in the first buffer solution.	To reduce the sensor response time, first move it about in the buffer solution and then hold it still.
	Buffer recognition termi- nated, the nominal buffer value is displayed, then zero point and temperature.	

Display	Action	Remark
	<p>Stability check. The measured value [mV] is displayed, "CAL2" and "enter" are blinking.</p> <p>Calibration with the first buffer is terminated. Remove the sensor from the first buffer solution and rinse it thoroughly.</p> <p>Use the arrow keys to select:</p> <ul style="list-style-type: none"> • END (1-point cal) • CAL2 (2-point cal) • REPEAT <p>Press enter to proceed.</p>	<p>Note: Stability check can be stopped after 10 sec (by pressing enter). However, this reduces calibration accuracy. Display for 1-point cal:</p>
	<p>Use the arrow keys to select:</p> <ul style="list-style-type: none"> • END (1-point cal) • CAL2 (2-point cal) • REPEAT <p>Press enter to proceed.</p>	 <p>Sensoface is active. Exit by pressing enter</p>
	<p>2-point calibration: Immerse sensor in second buffer solution. Press enter to start.</p>	<p>The calibration process runs as for the first buffer.</p>
	<p>Retract sensor out of second buffer, rinse off, re-install. Press enter to proceed.</p>	<p>The slope and asymmetry potential of the sensor (based on 25 °C) are displayed.</p>
	<p>Use the arrow keys to select:</p> <ul style="list-style-type: none"> • MEAS (exit) • REPEAT <p>Press enter to proceed. Exit: HOLD is deactivated with delay.</p>	<p>When 2-point cal is exited:</p> 

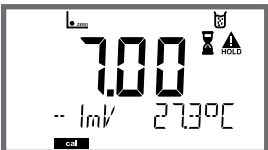
Manual Calibration



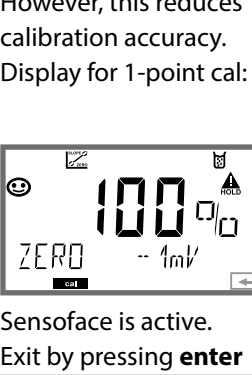
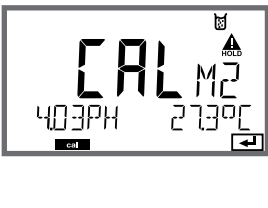

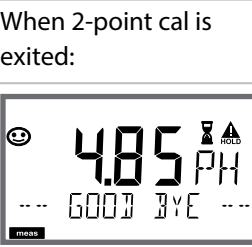

The MAN calibration mode and the type of temperature detection are selected during **configuration**. For calibration with manual buffer specification, you must enter the pH value of the buffer solution used in the device for the proper temperature. Any desired buffer solution can be used for calibration.

Display	Action	Remark
	Select Calibration. Press enter to proceed.	
	Ready for calibration. Hourglass blinks.	Display (3 sec) Now the device is in HOLD mode.
	Remove the sensor and temperature probe, clean them, and immerse them in the first buffer solution. Press enter to start.	When manual input of temperature has been configured, the temp value in the display blinks and can be edited using the arrow keys.
	Enter the pH value of your buffer solution for the proper temperature. While the "hourglass" icon is blinking, the sensor and temperature probe remain in the buffer solution.	The response time of the sensor and temperature probe is considerably reduced when the sensor is first moved about in the buffer solution and then held still.
		

Display	Action	Remark
	<p>At the end of the stability check, the value will be saved and the asymmetry potential will be displayed. Calibration with the first buffer is terminated. Remove the sensor and temp probe from the first buffer solution and rinse them thoroughly.</p> <p>Use the arrow keys to select:</p> <ul style="list-style-type: none"> • END (1-point cal) • CAL2 (2-point cal) • REPEAT <p>Press enter to proceed.</p>	<p>Note: Stability check can be stopped after 10 sec (by pressing enter). However, this reduces calibration accuracy. Display for 1-point cal:</p>
	<p>Sensoface is active. Exit by pressing enter</p>	
	<p>2-point calibration: Immerse sensor and temperature probe in the second buffer solution. Enter pH value. Press enter to start.</p>	<p>The calibration process runs as for the first buffer.</p>
	<p>Rinse sensor and temperature probe and reinstall them. Press enter to proceed.</p>	<p>Display of slope and asymmetry potential of the sensor (based on 25 °C).</p>
	<p>Use the arrow keys to select:</p> <ul style="list-style-type: none"> • MEAS (exit) • REPEAT <p>Press enter to proceed. Exit: HOLD is deactivated with delay.</p>	<p>When 2-point cal is exited:</p> 

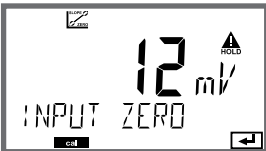
Premeasured Sensors

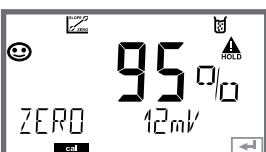
The DAT calibration mode must have been preset during configuration. You can directly enter the values for slope and asymmetry potential of a sensor. The values must be known, e.g., determined beforehand in the laboratory.

Display	Action	Remark
 The display shows 'CAL' in large digits, with 'CAL_PH' below it. There are navigation arrows on the left and right, and a 'cal' label at the bottom left. A 'HOLD' icon is in the top right corner.	Select Calibration. Press enter to proceed.	
 The display shows 'CAL' in large digits, with 'DATA INPUT' below it. There are navigation arrows on the left and right, and a 'cal' label at the bottom left. A 'HOLD' icon is in the top right corner.	"Data Input" Ready for calibration. Hourglass blinks.	Display (3 sec) Now the device is in HOLD mode.
 The display shows '12 mV' in large digits. Below it is 'INPUT ZERO'. There are navigation arrows on the left and right, and a 'cal' label at the bottom left. A 'HOLD' icon is in the top right corner.	Enter asymmetry potential [mV]. Press enter to proceed.	
 The display shows '95 %' in large digits. Below it is 'INPUT SLOPE'. There are navigation arrows on the left and right, and a 'cal' label at the bottom left. A 'HOLD' icon is in the top right corner.	Enter slope [%].	
 The display shows '95 %' in large digits. Below it is 'ZERO' and '12 mV'. There are navigation arrows on the left and right, and a 'cal' label at the bottom left. A 'HOLD' icon is in the top right corner.	The device displays the new slope and asymmetry potential (at 25 °C). Sensoface is active.	
 The display shows '7.23 pH' in large digits. Below it is 'MEAS'. There are navigation arrows on the left and right, and a 'cal' label at the bottom left. A 'HOLD' icon is in the top right corner.	Use the arrow keys to select: • MEAS (exit) • REPEAT Press enter to proceed.	Exit: HOLD is deactivated with delay.

Slope: Converting % to mV

Converting slope [%] to slope [mV/pH] at 25 °C

%	mV
78	46.2
80	47.4
82	48.5
84	49.7
86	50.9
88	52.1
90	53.3
92	54.5
94	55.6
96	56.8
98	58.0
100	59.2
102	60.4

Converting asymmetry potential to sensor zero point

$$\text{ZERO} = 7 - \frac{V_{AS} [\text{mV}]}{S [\text{mV}]}$$

ZERO = Sensor zero

V_{AS} = Asymmetry potential

S = Slope

ORP (Redox) Calibration

The potential of a redox sensor is calibrated using a **redox (ORP) buffer solution**. In the course of that, the difference between the measured potential and the potential of the calibration solution is determined according to the following equation. During measurement this difference is added to the measured potential.

$$mV_{\text{ORP}} = mV_{\text{meas}} - \Delta mV$$

mV_{ORP} = displayed ORP

mV_{meas} = direct sensor potential

ΔmV = delta value, determined during calibration

The sensor potential can also be related to another reference system – e.g., the standard hydrogen electrode. In that case the temperature-corrected potential (see table) of the reference electrode used must be entered during calibration.

During measurement, this value is then added to the ORP measured.

Please make sure that measurement and calibration temperature are the same since the temperature behavior of the reference electrode is not automatically taken into account.

Temperature dependence of reference systems measured against SHE

Temperature [°C]	Ag/AgCl/KCl 1 mol/l [ΔmV]	Ag/AgCl/KCl 3 mol/l [ΔmV]	Thalamid [ΔmV]	Mercury sulfate [ΔmV]
0	249	224	-559	672
10	244	217	-564	664
20	240	211	-569	655
25	236	207	-571	651
30	233	203	-574	647
40	227	196	-580	639
50	221	188	-585	631
60	214	180	-592	623
70	207	172	-598	613
80	200	163	-605	603

Calculating the rH (reference system: Ag/AgCl/KCl 3 mol/l)

$$rH = 2 \left(\frac{((\text{ORP} + E_{\text{REF}})/E_N) + \text{pH}}{2} \right)$$





ORP oxidation-reduction potential measured between the platinum electrode and the reference electrode

E_{REF} temperature-dependent potential of the reference electrode measured relative to SHE (standard hydrogen electrode)

E_N Nernst potential (temperature dependent)

pH currently measured pH value

ORP (Redox) Calibration

Display	Action	Remark
 <p>The LCD display shows 'CAL' in large digits at the top. Below it, 'CAL_ORP' is displayed. There are navigation arrows on the left and right sides, and a 'CAL' label at the bottom left.</p>	<p>Select ORP calibration. Press enter to proceed.</p>	
 <p>The LCD display shows 'CAL' in large digits at the top. Below it, 'ORP ADJUST' is displayed. There are navigation arrows on the left and right sides, and a 'CAL' label at the bottom left.</p>	<p>Remove the sensor and temperature probe, clean them, and immerse them in the redox buffer.</p>	<p>Display (3 sec) Now the device is in HOLD mode.</p>
 <p>The LCD display shows '220' in large digits with 'mV' to the right. Below it, 'SOLUTION 275°C' is displayed. There are navigation arrows on the left and right sides, and a 'CAL' label at the bottom left.</p>	<p>Enter setpoint value for redox buffer. Press enter to proceed.</p>	
 <p>The LCD display shows '213' in large digits with 'mV' to the right. Below it, 'ORP--DELTA' is displayed. There are navigation arrows on the left and right sides, and a 'CAL' label at the bottom left.</p>	<p>The ORP delta value is displayed (based on 25 °C). Sensoface is active. Press enter to proceed.</p>	
 <p>The LCD display shows '223' in large digits with 'mV' to the right. Below it, 'MEAS' is displayed. There are navigation arrows on the left and right sides, and a 'CAL' label at the bottom left.</p>	<p>To repeat calibration: Select REPEAT. To exit calibration: Select MEAS, then enter</p>	<p>After end of calibration, the outputs remain in HOLD mode for a short time.</p>

Product Calibration

Calibration by Sampling (One-Point Calibration).



During product calibration the sensor remains in the process.



The measurement process is only interrupted briefly.

Procedure:

- 1) The sample is measured in the lab or directly on the site using a portable meter.
To ensure an exact calibration, the sample temperature must correspond to the measured process temperature.
During sampling the device saves the currently measured value and then returns to measuring mode. The "calibration" mode indicator blinks.
- 2) In the second step you enter the measured sample value in the device. From the difference between the stored measured value and entered sample value, the device calculates the new asymmetry potential.

If the sample is invalid, you can take over the value stored during sampling. In that case, the old calibration values are stored. Afterwards, you can start a new product calibration.

Display	Action	Remark
	Select product calibration: P_CAL Press enter to proceed.	If you have protected the calibration with a passcode (in the Service menu), the device will return to measuring mode when an invalid code is entered.
	Ready for calibration. Hourglass blinks. Press enter to proceed.	Display (3 sec)
	Take sample and save value. Press enter to proceed.	Now the sample can be measured in the lab.

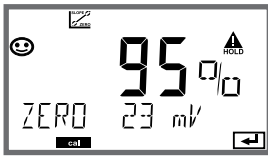
Display	Action	Remark
	The device returns to measuring mode.	From the blinking CAL mode indicator, you see that product calibration has not been terminated.
	Product calibration step 2: When the sample value has been determined, open the product calibration once more (P_CAL).	Display (3 sec) Now the device is in HOLD mode.
	The stored value is displayed (blinking) and can be overwritten with the measured sample value. Press enter to proceed.	
	Display of new asymmetry potential (based on 25 °C). Sensoface is active. To exit calibration: Select MEAS, then enter	To repeat calibration: Select REPEAT, then enter
End of calibration	After end of calibration, the outputs remain in HOLD mode for a short time.	

Measurement

Display



or AM/PM and °F:



Remark

From the configuration or calibration menus, you can switch the device to measuring mode by pressing the **meas** key.

In the measuring mode the upper display line shows the configured process variable (pH, ORP [mV] or temperature), the lower display line shows the time and the second configured process variable (pH, ORP [mV] or temperature). The [meas] mode indicator lights.

Note:

- After prolonged power outage (> 5 days), the time display is replaced by dashes and cannot be used for processing. In that case, enter the correct time.

By pressing the **meas** key you can step through the different displays. When no key has been pressed for 60 sec, the device returns to the standard display, see “Display in Measuring Mode” on page 20.



Further displays
(each by pressing **meas**).

- 1) Display of tag number (“TAG”)
- 2) Display of time and date
(without figure)

In the Diagnostics mode you can access the following menus without interrupting the measurement:

CALDATA	Viewing the calibration data
SENSOR	Viewing the sensor data
SELFTEST	Starting a device self-test
LOGBOOK	Viewing the logbook entries
MONITOR	Displaying currently measured values
VERSION	Displaying device type, software version, serial number

Access to diagnostics can be protected with a passcode (SERVICE menu).

Note:

HOLD is not active during Diagnostics mode!

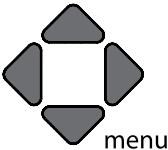
Action	Key	Remark
Activate diagnostics		Press menu key to call the selection menu. Select DIAG using ◀ ▶ keys, confirm by pressing enter
Select diagnostics option		Use ◀ ▶ keys to select from: CALDATA SENSOR SELFTEST LOGBOOK MONITOR VERSION See next pages for further proceeding.
Exit	meas	Exit by pressing meas .

Display

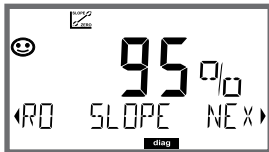

Menu item

Displaying the calibration data

Select CALDATA using ◀ ▶, confirm by pressing **enter**.

Use the ◀ ▶ keys to select from the bottom line of the display (LAST_CAL ZERO SLOPE NEXT_CAL).

The selected parameter is shown in the upper display line.

Press **meas** to return to measurement.

Displaying the sensor data

Manufacturer, type, serial number and last calibration date.

In each case Sensoface is active.

Display data using ◀ ▶ keys, return by pressing **enter** or **meas**.

Display

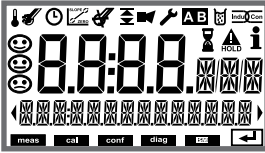

Menu item

Device self-test

(To abort, you can press **meas**.)

- 1 **Display test:** Display of all segments with changing background colors (white/green/red).
Proceed by pressing **enter**

- 2 **RAM test:** Hourglass blinks, then display of --PASS-- or --FAIL--
Proceed by pressing **enter**

- 3 **EEPROM test:** Hourglass blinks, then display of --PASS-- or --FAIL--
Proceed by pressing **enter**

- 4 **FLASH test:** Hourglass blinks, then display of --PASS-- or --FAIL--
Proceed by pressing **enter**

Display



Menu item

Displaying the logbook entries

Select LOGBOOK using ◀ ▶, press **enter** to confirm.

With the ▲ ▼ keys, you can scroll backwards and forwards through the logbook (entries -00...-99-), -00- being the last entry.





If the display is set to date/time, you can search for a particular date using the ▲ ▼ keys.

Press ◀ ▶ to view the corresponding message text.

If the display is set to the message text, you can search for a particular message using the ▲ ▼ keys.

Press ◀ ▶ to display the date and time.

Press **meas** to return to measurement.

Display	Menu item
	<p>Displaying the currently measured values (sensor monitor)</p> <p>Select MONITOR using $\leftarrow \rightarrow$, press enter to confirm. Use the $\leftarrow \rightarrow$ keys to select the desired parameter from the bottom line of the display. The selected parameter is shown in the upper display line.</p> <p>Press meas to return to measurement.</p>
<p>Display examples:</p>	<p>Display of mV_pH (for validation, sensor can be immersed in a calibration solution, for example, or the device is checked by using a simulator)</p> <p>Display of sensor operating time</p>
	<p>Version</p> <p>Display of device type, software/hardware version and serial number for all device components.</p> <p>Use the $\uparrow \downarrow$ keys to switch between software and hardware version.</p> <p>Press enter to proceed to next device component.</p>
	
	



Service



In the Service mode you can access the following menus:

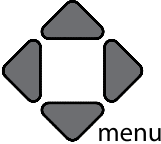

MONITOR	Displaying currently measured values
OUT1	Testing current output 1
OUT2	Testing current output 2
RELAIS	Testing the relay function
CODES	Assigning and editing passcodes
DEVICE TYPE	Selecting the device type (pH, Oxy, Cond)
DEFAULT	Resetting the device to factory settings

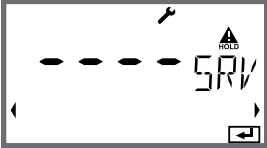
Note:

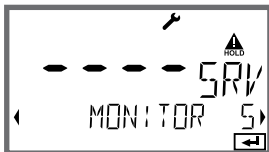
HOLD is active during Service mode!

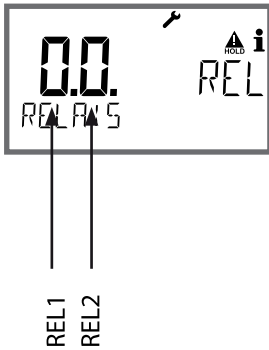
Action	Key/Display	Remark
Activate Service		Press menu key to call the selection menu. Select SERVICE using ◀ ▶ keys, press enter to confirm.
Passcode		Enter passcode "5555" for service mode using the ▲ ▼ ◀ ▶ keys. Press enter to confirm.
Display		In service mode the following icons are displayed: <ul style="list-style-type: none"> • HOLD triangle • Service (wrench)
Exit	meas	Exit by pressing meas .

Menu item	Remark
	<p>Displaying currently measured values (sensor monitor) with HOLD mode activated: Select MONITOR using ◀ ▶, press enter to confirm. Select the process variable in the bottom text line using ◀ ▶.</p> <p>The selected parameter is shown in the upper display line. As the device is in HOLD mode, you can perform validations using simulators without influencing the signal outputs.</p> <p>Hold meas depressed for longer than 2 sec to return to Service menu. Press meas once more to return to measurement.</p>
	<p>Specifying the current for outputs 1 and 2: Select OUT1 or OUT2 using the ◀ ▶ keys, press enter to confirm. Enter a valid current value for the respective output using ▲ ▼ ◀ ▶ keys. Confirm by pressing enter. For checking purposes, the actual output current is shown in the bottom right corner of the display. Exit by pressing enter or meas.</p>
	<p>Relay test (manual test of contacts): Select RELAIS using ◀ ▶, press enter to confirm. Now the status of the relays is "frozen". The 2 digits of the main display represent the respective states (from left to right: REL1, REL2). The selected digit blinks. Select one of the relays using the ◀ ▶ keys, close (1) or open (0) using the ▲ ▼ keys. Exit by pressing enter. The relays will be re-set corresponding to the measured value.</p> <p>Press meas to return to measurement.</p>

Menu item	Remark
	<p>Setting the passcodes: In the "SERVICE - CODES" menu you can assign passcodes to DIAG, HOLD, CAL, CONF and SERVICE modes (Service preset to 5555). When you have lost the Service passcode, you have to request an "Ambulance TAN" from the manufacturer specifying the serial number and hardware version of your device. To enter the "Ambulance TAN", call the Service function and enter passcode 7321. After correct input of the ambulance TAN the device signals "PASS" for 4 sec and resets the Service passcode to 5555.</p>
	<p>Reset to factory settings: In the "SERVICE - DEFAULT" menu you can reset the device to factory settings. NOTICE! After a reset to factory setting the device must be reconfigured completely, including the sensor parameters!</p>





Power Disruption while Loading the Process Variable

In very rare cases it seems that the analyzer cannot be operated because it remains in “Firmware Update” mode – indicated by the --FIRMW UPDATE-- message. This occurs when the power is disrupted while the process variable is loaded.





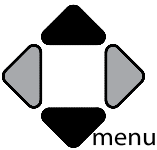

--FIRMW UPDATE--

Follow the instructions below to fix the error.

Action	Key/Display	Remark
Device start		If the power supply is disrupted while the process variable is loaded (e.g., during initial start-up or when changing the process variable), the following can occur:
Reconnecting the power supply		After the power supply has been reconnected, the analyzer starts and then remains in --FIRMW UPDATE-- mode. If this occurs, disconnect the power supply.
Restoring the factory settings		Press the ▲ ▼ keys simultaneously and hold them depressed while the analyzer is reconnected to the power supply.
Device start		Release the keys when the display shows LOADING BASE. The analyzer will restart with the BASE software when 100 % is reached.

Operating Error!

Action	Key/Display	Remark
Searching for the process variable		Then the analyzer searches for a measuring module or Memosens sensor.
Loading the process variable, automatic		When a module or a sensor has been found, the loading progress is shown in percentages.
Loading the process variable, manual		If neither module nor sensor are found, the display shows DEVICE TYPE. The selected process variable blinks. You can modify it using the ▲ ▼ keys. Press enter to load the process variable displayed.
Loading ...		Make sure that the power supply is not interrupted before the process variable is fully loaded (100%) .

Error Messages

Error	Info text (is displayed in case of fault when the Info key is pressed)	Problem Possible causes
ERR 99	DEVICE FAILURE	Error in factory settings EEPROM or RAM defective This error message only occurs in the case of a total defect. The device must be repaired and recalibrated at the factory.
ERR 98	CONFIGURATION ERROR	Error in configuration or calibration data Configuration or calibration data defective; completely reconfigure and recalibrate the device.
ERR 95	SYSTEM ERROR	System error Restart required. If error still persists, send in the device for repair.
ERR 01	NO SENSOR	Sensor error Device type not assigned Defective sensor Sensor not connected Break in sensor cable
ERR 02	WRONG SENSOR	Wrong sensor Replace the sensor.
ERR 04	SENSOR FAILURE	Failure in sensor Replace the sensor.
ERR 05	CAL DATA	Error in cal data
ERR 10	ORP RANGE	Display range exceeded ORP: < -1999 mV or > 1999 mV
ERR 11	RANGE	Display range exceeded
ERR 12	MV RANGE	mV range exceeded
ERR 13	TEMPERATURE RANGE	Temperature range exceeded Connect the sensor, check the sensor cable and replace if necessary, check the sensor connection, adjust the parameter settings.
ERR 14	rH RANGE	rH range exceeded
ERR 15	SENSOCHECK GLASS-EL	Glass Sensocheck (pH)

Error Messages

Error	Info text (is displayed in case of fault when the Info key is pressed)	Problem Possible causes
ERR 60	OUTPUT LOAD	Load error Check the current loop, deactivate unused current outputs.
ERR 61	OUTPUT 1 TOO LOW	Output current 1 < 0 (3.8) mA
ERR 62	OUTPUT 1 TOO HIGH	Output current 1 > 20.5 mA
ERR 63	OUTPUT 2 TOO LOW	Output current 2 < 0 (3.8) mA
ERR 64	OUTPUT 2 TOO HIGH	Output current 2 > 20.5 mA

Sensoface messages:

Calibration timer expired:	OUT OF CAL TIME CALIBRATE OR CHANGE SENSOR
Sensor zero/slope:	SENSOR ZERO/SLOPE CALIBRATE OR CHANGE SENSOR
ISFET sensor offset:	SENSOR ISFET-ZERO CALIBRATE OR CHANGE SENSOR
Sensor response:	SENSOR DRIFT CALIBRATE OR CHANGE SENSOR
Sensor TAG does not correspond to device entry.	WRONG SENSOR TAG
Sensor GROUP does not correspond to device entry.	WRONG SENSOR GROUP xxxx

Sensocheck, Sensoface Sensor Monitoring



Sensocheck continuously monitors the sensor and its wiring. The three Sensoface indicators provide information on required maintenance of the sensor. Additional icons refer to the error cause. Pressing the **info** key shows an information text.

Note:

The worsening of a Sensoface criterion leads to the devaluation of the Sensoface indicator (Smiley gets “sad”). An improvement of the Sensoface indicator can only take place after calibration or removal of the sensor defect.

Sensoface message

The Sensocheck message is also output as error message Err 15. The alarm contact is active, the display backlighting turns red, output current OUT is set to 22 mA (when configured correspondingly). All other Sensoface message can be output via a contact (relay contacts, alarm --> “FACE”).

Disabling Sensocheck and Sensoface

Sensocheck can be switched off in the configuration menu (then Sensoface is also disabled).

Exception:

After a calibration, a smiley is always displayed for confirmation.

Decommissioning























Disposal

Local codes and regulations must be observed when disposing of the product.



Returns

If required, send the product in a clean condition and securely packed to your local contact. See www.knick.de.

Operating States

Operating status	OUT 1	OUT 2	REL1/2	Time out
Measure				-
DIAG				60 s
CAL				No
CONF				20 min
SERVICE				20 min
SERVICE OUT 1				20 min
SERVICE OUT 2				20 min
SERVICE RELAY				20 min
Cleaning function				No
HOLD				No

Explanation:

-  as configured (Last/Fix or Last/Off)
-  active
-  manual

Product Range

Devices

Stratos MS A405N

Order No.

A405N

Mounting accessories

Pipe-mount kit

ZU0274

Panel-mount kit

ZU0738

Protective hood

ZU0737

M12 socket for sensor connection
with Memosens cable / M12 connector

ZU0860

Up-to-date information:

www.knick.de

Phone: +49 30 80191-0

Email: info@knick.de

Specifications

pH input	Memosens (terminals 1 ... 4)	
Data In/Out	Asynchronous interface, RS-485, 9600/19200 Bd	
Power supply	Terminal 1: +3.08 V/10 mA, Ri < 1 ohm, short-circuit-proof	
Display range	pH value	-2.00 ... 16.00
(depending on sensor)	ORP	-1999 ... 1999 mV
	Temperature	-20.0 ... +200.0 °C (-4 ... +392 °F)
	rH	0.0 ... 42.0 rH
pH sensor standardization *	pH calibration	
Operating modes	AUTO	Calibration with Calimatic automatic buffer recognition
	MAN	Manual calibration with entry of individual buffer values
	DAT	Data entry of premeasured sensors
	Product calibration	
Calimatic buffer sets *	-01- Mettler-Toledo	2.00/4.01/7.00/9.21
	-02- Knick CaliMat	2.00/4.00/7.00/9.00/12.00
	-03- Ciba (94)	2.06/4.00/7.00/10.00
	-04- NIST technical	1.68/4.00/7.00/10.01/12.46
	-05- NIST standard	1.679/4.006/6.865/9.180
	-06- HACH	4.01/7.00/10.01
	-07- WTW techn. buffers	2.00/4.01/7.00/10.00
	-08- Hamilton	4.01/7.00/10.01/12.00
	-09- Reagecon	2.00/4.00/7.00/9.00/12.00
	-10- DIN 19267	1.09/4.65/6.79/9.23/12.75
	-11- Hamilton A	2.00/4.01/7.00/9.00/11.00
	-12- Hamilton B	2.00/4.01/6.00/9.00/11.00
	-13- Kraft	2.00/4.00/7.00/9.00/11.00
	-U1-	Specifiable buffer set with 2 buffer solutions
Max. calibration range	Asymmetry potential	±60 mV
	Slope	80 ... 103 % (47.5 ... 61 mV/pH)
	(possibly restricting notes from Sensoface)	
ORP sensor standardization *	ORP calibration (zero adjustment)	
Max. calibration range	-700 ... +700 ΔmV	
Calibration timer	Interval 0000 ... 9999 h (Patent DE 101 41 408)	
Sensocheck	Automatic monitoring of glass electrode	
Delay	Approx. 30 s	
Sensoface	Provides information on the sensor condition (can be switched off) Evaluation of zero/slope, calibration interval, Sensocheck	
TC of process medium	Linear -19.99 ... +19.99 %/K, ultrapure water	
Reference temperature	25 °C	

¹⁾ user-defined

Specifications

HOLD input	Galvanically separated (optocoupler)
Function	Switches device to HOLD mode
Switching voltage	0 ... 2 V AC/DC HOLD inactive 10 ... 30 V AC/DC HOLD active
Output 1	0/4 ... 20 mA, max. 10 V, floating (terminals 8 / 9, galvanically connected to output 2)
Overrange *	22 mA in the case of error messages
Characteristic	Linear
Output filter *	PT ₁ filter, time constant 0 ... 120 s
Measurement error ¹⁾	< 0.25% current value + 0.025 mA
Output 2	0/4 ... 20 mA, max. 10 V, floating (terminals 9 / 10, galvanically connected to output 1)
Overrange *	22 mA in the case of error messages
Characteristic	Linear
Output filter *	PT ₁ filter, time constant 0 ... 120 s
Measurement error ¹⁾	< 0.25% current value + 0.025 mA

^{*)} user-defined

¹⁾ at normal operating conditions

Relays 1 / 2	Two relay contacts, floating (terminals 14 / 15 / 16)	
Contact ratings	AC < 250 V / < 3 A / < 750 VA DC < 30 V / < 3 A / < 90 W	
Usage	Limit value Alarm Wash	
Limit value	Function	Min or Max
	Setpoint	As desired within range
	Contact response	N/C or N/O
	Hysteresis	User-defined
	Response delay	0000 ... 9999 s
Alarm	Trigger	Failure or Sensoface
	Contact response	N/C or N/O
Wash	Cycle time	0.1 ... 999.9 h
	ON time	0 ... 1999 s
	Contact response	N/C or N/O
Real-time clock	Different time and date formats selectable	
Power reserve	> 5 days	
Display	LC display, 7-segment with icons, colored backlighting	
Primary display	Character height approx. 22 mm, unit symbols approx. 14 mm	
Secondary display	Character height approx. 10 mm	
Text line	14 characters, 14 segments	
Sensoface	3 status indicators (friendly, neutral, sad face)	
Mode indicators	meas, cal, conf, diag Further icons for configuration and messages	
Alarm indication	Display blinks, red backlighting	
Keypad	Keys: meas, info, 4 cursor keys, enter	
Diagnostics		
Calibration data	Calibration date, zero, slope	
Device self-test	Automatic memory test (RAM, FLASH, EEPROM)	
Display test	Display of all segments	
Logbook	100 events with date and time	

Specifications

Service functions

Current source	Current specifiable for output 1 and 2 (00.00 ... 22.00 mA)
Sensor monitor	Display of direct sensor signals (mV/temperature/operating time)
Relay test	Manual control of relay contacts
Device type	Selecting the measuring function

Data retention	Parameters, calibration data, logbook > 10 years (EEPROM)
-----------------------	---

Electrical safety	Protection against electric shock by protective separation of all extra-low-voltage circuits against mains according to EN 61010-1
--------------------------	--

EMC	EN 61326-1
------------	------------

Emitted interference	Class A (industrial applications) ¹⁾
----------------------	---

Immunity to interference	Industrial applications
--------------------------	-------------------------

RoHS conformity	according to EC directive 2011/65/EU
------------------------	--------------------------------------

Power supply	80 V (-15%) ... 230 (+10%) V AC ; approx. 15 VA ; 45 ... 65 Hz 24 V (-15%) ... 60 (+10%) V DC ; 10 W Overvoltage category II, protection class II
---------------------	---

Nominal operating conditions

Climatic class	3K5 according to EN 60721-3-3
----------------	-------------------------------

Location class	C1 according to EN 60654-1
----------------	----------------------------

Ambient temperature	-20 ... 65 °C / -4 ... 149 °F
---------------------	-------------------------------

Relative humidity	10 ... 95 %
-------------------	-------------

Transport and storage

Transport/Storage temperature	-30 ... 70 °C / -22 ... 158 °F
-------------------------------	--------------------------------

Enclosure	Molded enclosure made of PBT/PC, glass fiber reinforced
------------------	---

Mounting	Wall, pipe/post or panel mounting
----------	-----------------------------------

Color	Gray, RAL 7001
-------	----------------

Ingress protection	IP66/IP67/TYPE 4X outdoor (with pressure compensation) when the device is closed
--------------------	--

Flammability	UL 94 V-0 for external parts
--------------	------------------------------

Dimensions	H 148 mm, W 148 mm, D 117 mm
------------	------------------------------

Control panel cutout	138 mm x 138 mm to DIN 43 700
----------------------	-------------------------------

Weight	1.2 kg (1.6 kg incl. accessories and packaging)
--------	---

Cable glands	5 knockouts for M20 x 1.5 cable glands 2 of 5 knockouts for NPT ½" or rigid metallic conduit
--------------	---

Terminals

Screw terminals	for single or stranded wires 0.2 ... 2.5 mm ²
-----------------	--

Tightening torque	0.5 ... 0.6 Nm
-------------------	----------------

¹⁾ This equipment is not designed for domestic use, and is unable to guarantee adequate protection of the radio reception in such environments.

Buffer Tables

-01- Mettler-Toledo
(corresponds to former "Knick technical buffers")
Nominal values in bold.

°C	pH			
0	2.03	4.01	7.12	9.52
5	2.02	4.01	7.09	9.45
10	2.01	4.00	7.06	9.38
15	2.00	4.00	7.04	9.32
20	2.00	4.00	7.02	9.26
25	2.00	4.01	7.00	9.21
30	1.99	4.01	6.99	9.16
35	1.99	4.02	6.98	9.11
40	1.98	4.03	6.97	9.06
45	1.98	4.04	6.97	9.03
50	1.98	4.06	6.97	8.99
55	1.98	4.08	6.98	8.96
60	1.98	4.10	6.98	8.93
65	1.99	4.13	6.99	8.90
70	1.99	4.16	7.00	8.88
75	2.00	4.19	7.02	8.85
80	2.00	4.22	7.04	8.83
85	2.00	4.26	7.06	8.81
90	2.00	4.30	7.09	8.79
95	2.00	4.35	7.12	8.77

Buffer Tables

-02- Knick CaliMat
(Merck Titrisols, Riedel-de-Haen Fixanals)
Nominal values in bold.

°C	pH				
0	2.01	4.05	7.09	9.24	12.58
5	2.01	4.04	7.07	9.16	12.39
10	2.01	4.02	7.04	9.11	12.26
15	2.00	4.01	7.02	9.05	12.13
20	2.00	4.00	7.00	9.00	12.00
25	2.00	4.01	6.99	8.95	11.87
30	2.00	4.01	6.98	8.91	11.75
35	2.00	4.01	6.96	8.88	11.64
40	2.00	4.01	6.96	8.85	11.53
50	2.00	4.01	6.96	8.79	11.31
60	2.00	4.00	6.96	8.73	11.09
70	2.00	4.00	6.96	8.70	10.88
80	2.00	4.00	6.98	8.66	10.68
90	2.00	4.00	7.00	8.64	10.48

-03- Ciba (94) buffers
 Nominal values: 2.06 4.00 7.00 10.00

°C	pH			
0	2.04	4.00	7.10	10.30
5	2.09	4.02	7.08	10.21
10	2.07	4.00	7.05	10.14
15	2.08	4.00	7.02	10.06
20	2.09	4.01	6.98	9.99
25	2.08	4.02	6.98	9.95
30	2.06	4.00	6.96	9.89
35	2.06	4.01	6.95	9.85
40	2.07	4.02	6.94	9.81
45	2.06	4.03	6.93	9.77
50	2.06	4.04	6.93	9.73
55	2.05	4.05	6.91	9.68
60	2.08	4.10	6.93	9.66
65	2.07*	4.10*	6.92*	9.61*
70	2.07	4.11	6.92	9.57
75	2.04*	4.13*	6.92*	9.54*
80	2.02	4.15	6.93	9.52
85	2.03*	4.17*	6.95*	9.47*
90	2.04	4.20	6.97	9.43
95	2.05*	4.22*	6.99*	9.38*

* extrapolated

Buffer Tables

-04- NIST technical buffers
Nominal values in bold.

°C	pH				
0	1.67	4.00	7.115	10.32	13.42
5	1.67	4.00	7.085	10.25	13.21
10	1.67	4.00	7.06	10.18	13.01
15	1.67	4.00	7.04	10.12	12.80
20	1.675	4.00	7.015	10.06	12.64
25	1.68	4.005	7.00	10.01	12.46
30	1.68	4.015	6.985	9.97	12.30
35	1.69	4.025	6.98	9.93	12.13
40	1.69	4.03	6.975	9.89	11.99
45	1.70	4.045	6.975	9.86	11.84
50	1.705	4.06	6.97	9.83	11.71
55	1.715	4.075	6.97	9.83*	11.57
60	1.72	4.085	6.97	9.83*	11.45
65	1.73	4.10	6.98	9.83*	11.45*
70	1.74	4.13	6.99	9.83*	11.45*
75	1.75	4.14	7.01	9.83*	11.45*
80	1.765	4.16	7.03	9.83*	11.45*
85	1.78	4.18	7.05	9.83*	11.45*
90	1.79	4.21	7.08	9.83*	11.45*
95	1.805	4.23	7.11	9.83*	11.45*

* Values complemented

-05- NIST Standard (DIN 19266 : 2015-05)
Nominal values in bold.

°C	pH				
0	1.666	4.000	6.984	9.464	
5	1.668	3.998	6.951	9.395	13.207
10	1.670	3.997	6.923	9.332	13.003
15	1.672	3.998	6.900	9.276	12.810
20	1.675	4.000	6.881	9.225	12.627
25	1.679	4.005	6.865	9.180	12.454
30	1.683	4.011	6.853	9.139	12.289
35	1.688	4.018	6.844	9.102	12.133
37		4.022	6.841	9.088	
38	1.691				12.043
40	1.694	4.027	6.838	9.068	11.984
45					11.841
50	1.707	4.050	6.833	9.011	11.705
55	1.715	4.075	6.834	8.985	11.574
60	1.723	4.091	6.836	8.962	11.449
70	1.743	4.126	6.845	8.921	
80	1.766	4.164	6.859	8.885	
90	1.792	4.205	6.877	8.850	
95	1.806	4.227	6.886	8.833	

Note: The actual pH values of the individual batches of the reference materials are documented in a certificate of an accredited laboratory. This certificate is supplied with the respective buffers. Only these pH(S) values shall be used as standard values for the secondary reference buffer materials. Correspondingly, this standard does not include a table with standard pH values for practical use. The table above only provides examples of pH(PS) values for orientation.

Buffer Tables

-06- HACH buffers
Nominal values in bold.

°C	pH		
0	4.00	7.118	10.30
5	4.00	7.087	10.23
10	4.00	7.059	10.17
15	4.00	7.036	10.11
20	4.00	7.016	10.05
25	4.01	7.00	10.00
30	4.01	6.987	9.96
35	4.02	6.977	9.92
40	4.03	6.97	9.88
45	4.05	6.965	9.85
50	4.06	6.964	9.82
55	4.07	6.965	9.79
60	4.09	6.968	9.76
65	4.10	6.98	9.71
70	4.12	7.00	9.66
75	4.14	7.02	9.63
80	4.16	7.04	9.59
85	4.18	7.06	9.56
90	4.21	7.09	9.52
95	4.24	7.12	9.48

-07- WTW technical buffers
Nominal values in bold.

°C	pH			
0	2.03	4.01	7.12	10.65
5	2.02	4.01	7.09	10.52
10	2.01	4.00	7.06	10.39
15	2.00	4.00	7.04	10.26
20	2.00	4.00	7.02	10.13
25	2.00	4.01	7.00	10.00
30	1.99	4.01	6.99	9.87
35	1.99	4.02	6.98	9.74
40	1.98	4.03	6.97	9.61
45	1.98	4.04	6.97	9.48
50	1.98	4.06	6.97	9.35
55	1.98	4.08	6.98	
60	1.98	4.10	6.98	
65	1.99	4.13	6.99	
70	2.00	4.16	7.00	
75	2.00	4.19	7.02	
80	2.00	4.22	7.04	
85	2.00	4.26	7.06	
90	2.00	4.30	7.09	
95	2.00	4.35	7.12	

Buffer Tables

-08- Hamilton Duracal buffers
Nominal values in bold.

°C	pH				
0	1.99	4.01	7.12	10.23	12.58
5	1.99	4.01	7.09	10.19	12.46
10	2.00	4.00	7.06	10.15	12.34
15	2.00	4.00	7.04	10.11	12.23
20	2.00	4.00	7.02	10.06	12.11
25	2.00	4.01	7.00	10.01	12.00
30	1.99	4.01	6.99	9.97	11.90
35	1.98	4.02	6.98	9.92	11.80
40	1.98	4.03	6.97	9.86	11.70
45	1.97	4.04	6.97	9.83	11.60
50	1.97	4.05	6.97	9.79	11.51
55	1.98	4.06	6.98	9.75	11.42
60	1.98	4.08	6.98	9.72	11.33
65	1.98	4.10*	6.99*	9.69*	11.24
70	1.99	4.12*	7.00*	9.66*	11.15
75	1.99	4.14*	7.02*	9.63*	11.06
80	2.00	4.16*	7.04*	9.59*	10.98
85	2.00	4.18*	7.06*	9.56*	10.90
90	2.00	4.21*	7.09*	9.52*	10.82
95	2.00	4.24*	7.12*	9.48*	10.74

* Values complemented

-09- Reagecon buffers
Nominal values in bold.

°C	pH				
0	2.01*	4.01*	7.07*	9.18*	12.54*
5	2.01*	4.01*	7.07*	9.18*	12.54*
10	2.01	4.00	7.07	9.18	12.54
15	2.01	4.00	7.04	9.12	12.36
20	2.01	4.00	7.02	9.06	12.17
25	2.00	4.00	7.00	9.00	12.00
30	1.99	4.01	6.99	8.95	11.81
35	2.00	4.02	6.98	8.90	11.63
40	2.01	4.03	6.97	8.86	11.47
45	2.01	4.04	6.97	8.83	11.39
50	2.00	4.05	6.96	8.79	11.30
55	2.00	4.07	6.96	8.77	11.13
60	2.00	4.08	6.96	8.74	10.95
65	2.00*	4.10*	6.99*	8.70*	10.95*
70	2.00*	4.12*	7.00*	8.67*	10.95*
75	2.00*	4.14*	7.02*	8.64*	10.95*
80	2.00*	4.16*	7.04*	8.62*	10.95*
85	2.00*	4.18*	7.06*	8.60*	10.95*
90	2.00*	4.21*	7.09*	8.58*	10.95*
95	2.00*	4.24*	7.12*	8.56*	10.95*

* Values complemented

Buffer Tables

-10- DIN 19267 buffers
Nominal values in bold.

pH	°C				
0	1.08	4.67	6.89	9.48	13.95*
5	1.08	4.67	6.87	9.43	13.63*
10	1.09	4.66	6.84	9.37	13.37
15	1.09	4.66	6.82	9.32	13.16
20	1.09	4.65	6.80	9.27	12.96
25	1.09	4.65	6.79	9.23	12.75
30	1.10	4.65	6.78	9.18	12.61
35	1.10	4.65	6.77	9.13	12.45
40	1.10	4.66	6.76	9.09	12.29
45	1.10	4.67	6.76	9.04	12.09
50	1.11	4.68	6.76	9.00	11.89
55	1.11	4.69	6.76	8.96	11.79
60	1.11	4.70	6.76	8.92	11.69
65	1.11	4.71	6.76	8.90	11.56
70	1.11	4.72	6.76	8.88	11.43
75	1.11	4.73	6.77	8.86	11.31
80	1.12	4.75	6.78	8.85	11.19
85	1.12	4.77	6.79	8.83	11.09
90	1.13	4.79	6.80	8.82	10.99
95	1.13*	4.82*	6.81*	8.81*	10.89*

* extrapolated

-11- Hamilton A
Nominal values in bold.

pH	°C				
0	1.99	4.01	7.12	9.31	11.42
5	1.99	4.01	7.09	9.24	11.33
10	2.00	4.00	7.06	9.17	11.25
15	2.00	4.00	7.04	9.11	11.16
20	2.00	4.00	7.02	9.05	11.07
25	2.00	4.01	7.00	9.00	11.00
30	1.99	4.01	6.99	8.95	10.93
35	1.98	4.02	6.98	8.90	10.86
40	1.98	4.03	6.97	8.85	10.80
45	1.97	4.04	6.97	8.82	10.73
50	1.97	4.05	6.97	8.78	10.67
55	1.98	4.06	6.98	8.75	10.61
60	1.98	4.08	6.98	8.72	10.55
65	1.98	4.10	6.99	8.70	10.49
70	1.99	4.12	7.00	8.67	10.43
75	1.99	4.14	7.02	8.64	10.38
80	2.00	4.16	7.04	8.62	10.33
85	2.00	4.18	7.06	8.60	10.28
90	2.00	4.21	7.09	8.58	10.23
95	2.00	4.24	7.12	8.56	10.18

Buffer Tables

-12- Hamilton B
Nominal values in bold.

pH	°C				
0	1.99	4.01	6.03	9.31	11.42
5	1.99	4.01	6.02	9.24	11.33
10	2.00	4.00	6.01	9.17	11.25
15	2.00	4.00	6.00	9.11	11.16
20	2.00	4.00	6.00	9.05	11.07
25	2.00	4.01	6.00	9.00	11.00
30	1.99	4.01	6.00	8.95	10.93
35	1.98	4.02	6.00	8.90	10.86
40	1.98	4.03	6.01	8.85	10.80
45	1.97	4.04	6.02	8.82	10.73
50	1.97	4.05	6.04	8.78	10.67
55	1.98	4.06	6.06	8.75	10.61
60	1.98	4.08	6.09	8.72	10.55
65	1.98	4.10	6.11	8.70	10.49
70	1.99	4.12	6.13	8.67	10.43
75	1.99	4.14	6.15	8.64	10.38
80	2.00	4.16	6.18	8.62	10.33
85	2.00	4.18	6.21	8.60	10.28
90	2.00	4.21	6.24	8.58	10.23
95	2.00	4.24	6.27	8.56	10.18

-13- Kraft
Nominal values in bold.

pH	°C				
0	2.01	4.05	7.13	9.24	11.47*
5	2.01	4.04	7.07	9.16	11.47
10	2.01	4.02	7.05	9.11	11.31
15	2.00	4.01	7.02	9.05	11.15
20	2.00	4.00	7.00	9.00	11.00
25	2.00	4.01	6.98	8.95	10.85
30	2.00	4.01	6.98	8.91	10.71
35	2.00	4.01	6.96	8.88	10.57
40	2.00	4.01	6.95	8.85	10.44
45	2.00	4.01	6.95	8.82	10.31
50	2.00	4.00	6.95	8.79	10.18
55	2.00	4.00	6.95	8.76	10.18*
60	2.00	4.00	6.96	8.73	10.18*
65	2.00	4.00	6.96	8.72	10.18*
70	2.01	4.00	6.96	8.70	10.18*
75	2.01	4.00	6.96	8.68	10.18*
80	2.01	4.00	6.97	8.66	10.18*
85	2.01	4.00	6.98	8.65	10.18*
90	2.01	4.00	7.00	8.64	10.18*
95	2.01	4.00	7.02	8.64	10.18*

* Values complemented

-U1- Specifiable Buffer Set

You can specify a buffer set with 2 buffer solutions in the temperature range of 0 ... 95 °C, step width: 5 °C.

To do so, select buffer set -U1- in the configuration menu.

As delivered, the Ingold technical buffer solutions pH 4.01 / 7.00 are stored as buffer set and can be edited.



Conditions for the specifiable buffer set:

- All values must lie in the range pH 0 ... 14
- Maximum difference between two adjacent pH values (5 °C step width) of the same buffer solution: pH 0.25
- The values of buffer solution 1 must be lower than those of buffer solution 2:
The difference between values for identical temperatures must be greater than 2 pH units.

Faulty entries are indicated in measuring mode by the "FAIL BUFFERSET -U1-" message.

The 25 °C value is always used for buffer display during calibration.

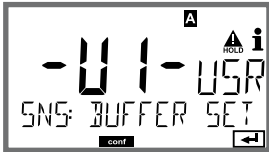
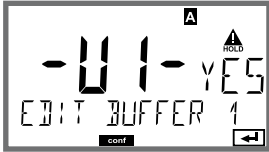
-U1- Specifiable Buffer Set

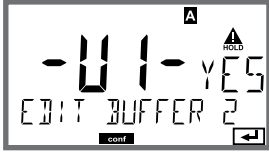
Step	Action/Display	Remark
Select buffer set -U1- (CONFIG / SNS menu)		
Select buffer solution 1 for editing	 <p>Select "YES" using up/down key.</p>	You are prompted for confirmation to prevent accidental changes of the settings.
Editing the values of buffer solution 1	 <p>Edit using arrow keys, press enter to confirm and proceed to next temperature value.</p> 	Enter the values for the first buffer solution in 5°C steps. The difference to the next value must not exceed 0.25 pH unit.
Select buffer solution 2 for editing		The difference between buffer solutions for identical temperatures must be greater than 2 pH units.

-U1- Specifiable Buffer Set

Buffer Set U1:

Fill in your configuration data or use the table as original for copy.

Temperature (°C)	Buffer 1	Buffer 2
5		
10		
15		
20		
25		
30		
35		
40		
45		
50		
55		
60		
65		
70		
75		
80		
85		
90		
95		

A

Accessories 86
Alarm delay 42
Alarm, relay contacts 50
Ambulance TAN 78
Assembly 9
Assigning measured values, current start/end 37
Asymmetry potential to sensor zero point 65
Automatic calibration 60

B

Backlighting 19
Buffer set, selection 33
Buffer tables 91
Buttons and functions 18

C

Cable glands 8
CALDATA 72
Calibration, AUTO 60
Calibration, DAT 64
Calibration data, display 72
Calibration, MAN 62
Calibration mode (configuration) 33
Calibration mode selection 59
Calibration (pH) 58
Calibration timer 33
Calibration with premeasured sensors 64
Calibration with sampling 68
CAL_ORP 67
CAL_PH 59
Capacitive loads, protective wiring of relay contacts 54
Commissioning 6
Configuration, alarm delay 42
Configuration, current output 36
Configuration, measuring point 56
Configuration, menu structure 25
Configuration, output current 36
Configuration, overview 28
Configuration (pH) 32
Configuration, relay contacts 46

- Configuration, Sensocheck 42
- Configuration, sensor verification (TAG, GROUP) 34
- Configuration, temperature compensation 44
- Configuration, time and date 56
- Configuration, time averaging filter 38
- Connecting a Memosens sensor, menu 26
- Connecting a Memosens sensor, terminal assignments 14
- Controlling a rinsing probe via relay contacts 52
- Converting slope to mV 65
- Current calibration data, display 72
- Currently measured values (sensor monitor) 75
- Currently measured values (sensor monitor), display with HOLD activated 77
- Current output, configuration 36
- Current source 77
- Current start/end, assigning measured values 37

D

- DATA INPUT (calibration) 64
- Date and time, usage 57
- Date, display 70
- Date, setting 56
- Decommissioning 84
- Device self-test 73
- Device start blocked 79
- Device type, display 75
- Device type pH, configuration 32
- Diagnostics, calibration data 72
- Diagnostics, device self-test 73
- Diagnostics, logbook 74
- Diagnostics mode 71
- Diagnostics, sensor data 72
- Diagnostics, sensor monitor 75
- Diagnostics, version 75
- Dimensions 10
- Disabling Sensocheck 43
- Display 19
- Display backlighting 19
- Display, icons 19
- Displaying the time/date 70
- Display in measuring mode 20
- Display, selecting the main display 20

Display test 73
Disposal 84
Documentation 5

E

EEPROM test 73
Electrical installation 13
Enclosure components 9
Enclosure, mounting possibilities 8
ERR 81
Error and HOLD, output current 40
Error messages 81

F

Factory setting 78
FIRMW UPDATE 79
FLASH test 73

G

GROUP of measuring points 57

H

HOLD, configure output current 40
HOLD, exit 23
HOLD, external activation 23
HOLD mode 23
HOLD, output signal 23
HOLD, output signal response 23
Hose clamps 11
Hysteresis of relay contacts 48

I

Icons 19
Inductive loads, protective wiring of relay contacts 54
Info text 81
Installation, notices 13
Installation, terminal assignments 14
Intended use 7
Introduction 8

K

Keys and functions 18

L

- Limit values (relay contacts) 46
- Linear temperature compensation (pH) 45
- LOGBOOK 74
- Logbook entries, display 74
- Loss of passcode 78

M

- MAIN DISPLAY 20
- Manual calibration 62
- Measured values, display 75
- Measuring function (device type) 76
- Measuring mode 70
- Measuring point (TAG/GROUP) 56
- Memosens sensor (connection, menu) 26
- Memosens sensor (connection, terminal assignments) 14
- Memosens sensor (replacement) 27
- MemoSuite software for calibrating Memosens sensors 15
- Menu structure 24
- Menu structure, configuration 25
- Mounting accessories 10
- Mounting accessories, product range 86
- Mounting plan 10

O

- Operating error FIRMW UPDATE 79
- Operating mode, selection 21
- Operating modes, overview 22
- Operating states 85
- Operation, general 17
- Order codes 86
- ORP (redox) calibration 66
- Output current during Error and HOLD 40
- Output current, fixed value 77
- Output current, range 37
- Output current, time averaging filter 38
- Output filter, time interval 38
- Output signal during HOLD (configuration) 41
- Output signal during HOLD, overview 23
- Overview of configuration 28

P

- Package contents, complete 9
- Package contents, documentation 5
- Panel mounting 12
- Passcode lost 78
- Passcodes, setting 78
- P_CAL, product calibration (calibration with sampling) 68
- pH calibration, presetting 59
- pH configuration 32
- Post/pipe mounting 11
- Power supply, connection 14
- Power supply, specifications 90
- Process variable not loaded 79
- Process variable selection 37
- Product calibration 68
- Product line 86
- Protective hood 11
- Protective wiring of relay contacts 54

Q

- Quickstart guides 5

R

- RAM test 73
- Rating plates 13
- Redox (ORP) calibration 66
- Relay 46
- Relay contact delay 48
- Relay contacts, alarm 50
- Relay contacts, controlling a rinsing probe 52
- Relay contacts, function assignment, limit values 46
- Relay contacts, protective wiring 54
- Relay test (manual test of contacts) 77
- Replacing a Memosens sensor 27
- Reset to factory settings 78
- Returns 84
- rH calculation 66
- Rinsing probes, activating 52

S

- Safety 6
- Safety guide 5
- Selecting the device type 76
- Sensocheck (configuration) 43
- Sensocheck, description 83
- Sensoface, configure output current 41
- Sensoface, description 83
- Sensoface messages, overview 82
- Sensor data, display 72
- Sensor monitor, diagnostics 75
- Sensor monitor, Service mode 77
- Sensor replacement 27
- Sensor verification (TAG, GROUP) 34
- Serial number, display 75
- Series resistors 54
- Service life of contacts 54
- Service mode 76
- Service passcode lost 78
- Service, relay test 77
- Service, reset to factory settings 78
- Service, sensor monitor 77
- Service, setting the passcodes 78
- Service, specify output current 77
- Settings of U1 buffer set 106
- Signal colors 19
- Software version, display 75
- Specifiable buffer set, -U1- 104
- Specifications 87
- Specifying the output current 77
- Start-up 15
- Supplemental directives 2
- Switching characteristics (function) 46

T

- Tag number, display 70
- TAG of measuring point 57
- Technical data 87
- Temperature compensation 44
- Temperature dependence of reference systems against SHE 66
- Temperature unit 32
- Terminal assignments 14
- Terminals 13
- Test report 2.2 5
- Time and date, usage 57
- Time averaging filter 39
- Time, display 70
- Time format, setting 56
- Time, setting 56

U

- U1, specifiable buffer set 104
- Use of relays 46

V

- Viewing parameters 70

W

- Weather protector 11
- Wiring 14
- Wrench icon 76

Z

- ZU 0274 pipe-mount kit 11
- ZU 0737 protective hood 11
- ZU 0738 panel-mount kit 12



Knick
Elektronische Messgeräte
GmbH & Co. KG

Headquarters

Beuckestraße 22 • 14163 Berlin

Germany

Phone: +49 30 80191-0

Fax: +49 30 80191-200

info@knick.de

www.knick.de

Local Contacts

www.knick-international.com

Translation of the original instructions

Copyright 2022 • Subject to change

Version: 3 • This document was published on April 26, 2022.

The latest documents are available for download on our website under the corresponding product description.



100137

TA-212.100-pH-KNEN03