

# Stratos Pro A201MSPH

pH Measurement  
with Memosens Sensors

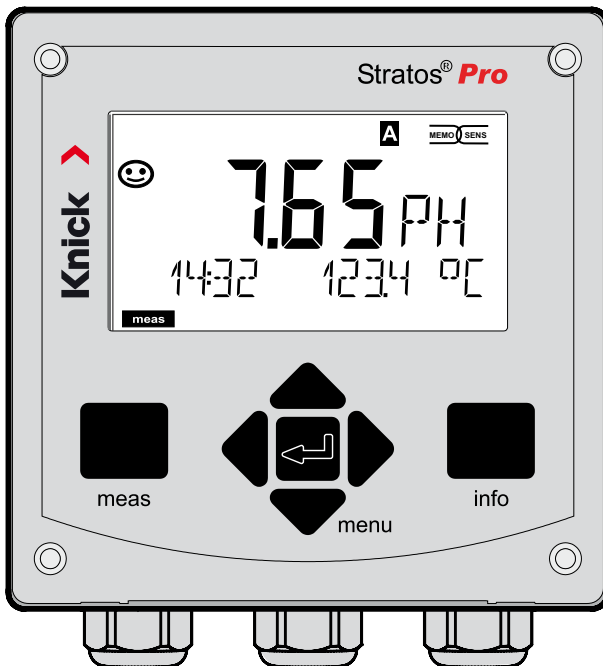

Read before installation.  
Keep for future use.

# Supplemental Directives

---

Read this document and retain it for future reference. Before assembling, installing, operating, or maintaining the product, ensure that you fully understand the instructions and risks. Observe all safety instructions. Failure to follow the instructions in this document may result in serious injury and/or property damage.

This document is subject to change without notice.

These supplemental directives explain how safety information is laid out in this document and what content it covers.

## Safety Chapter



This document's Safety chapter is designed to give the reader a basic understanding of safety. It illustrates general hazards and gives strategies on how to avoid them.

## Safety Guide

The external Safety Guide is designed to give the reader a basic understanding of safety. It illustrates general hazards and suggests strategies on how to avoid them.

## Warnings

This document uses the following warnings to indicate hazardous situations:

Symbol	Category	Meaning	Remark
	WARNING	Designates a situation that can lead to death or serious (irreversible) injury.	The warnings contain information on how to avoid the hazard.
	CAUTION	Designates a situation that can lead to slight or moderate (reversible) injury.	
None	NOTICE	Designates a situation that can lead to property or environmental damage.	

## Additional Safety Information

Stratos Safety Guide

## **Safety Guide**

In official EU languages and others

## **Quickstart Guides**

Installation and first steps:

- Operation
- Menu structure
- Calibration
- Error messages and recommended actions

## **Test Report 2.2 According to EN 10204**

## **Electronic Documentation**

[www.knick-international.com](http://www.knick-international.com):

Manuals + software

Ex devices:

## **Control Drawings**

## **EU Declaration of Conformity**

# Table of Contents

---

<b>Supplemental Directives</b> .....	<b>2</b>
<b>Documents Supplied</b> .....	<b>3</b>
<b>Safety</b> .....	<b>7</b>
Intended Use.....	7
<b>Introduction</b> .....	<b>9</b>
<b>Overview of Stratos Pro A201MSPH</b> .....	<b>12</b>
<b>Assembly</b> .....	<b>13</b>
Package Contents.....	13
Mounting Plan, Dimensions .....	14
Pipe Mounting, Protective Hood .....	15
Panel Mounting.....	16
<b>Electrical Installation</b> .....	<b>17</b>
Rating Plates / Terminal Assignments.....	18
Wiring of Stratos Pro A201 MSPH.....	19
Connecting a Memosens Sensor.....	20
Wiring Examples .....	21
<b>User Interface, Keypad</b> .....	<b>23</b>
<b>Display</b> .....	<b>24</b>
Signal Colors (Display Backlighting).....	24
Measuring Mode.....	25
Selecting the Mode / Entering Values .....	26
<b>Display in Measuring Mode</b> .....	<b>27</b>
<b>Color-Coded User Interface</b> .....	<b>28</b>
<b>Operating Modes</b> .....	<b>29</b>
Menu Structure of Modes and Functions.....	30
HOLD Mode.....	31
Alarm.....	32
Alarm and HOLD Messages .....	33

<b>Configuration</b> .....	<b>34</b>
Menu Structure of Configuration .....	34
Parameter Set Selection.....	36
Configuration (Template for Copy).....	42
Sensor .....	44
Sensor Verification (TAG, GROUP) .....	54
Current Output 1 .....	56
Current Output 2.....	64
Temperature Compensation .....	66
CONTROL Input (TAN SW-A005) .....	70
Alarm Settings.....	72
Time and Date .....	76
Measuring Points (TAG/GROUP) .....	78
Display Backlighting.....	78
<b>Digital Sensors</b> .....	<b>80</b>
Memosens Sensors:	
Calibration and Maintenance in the Lab .....	80
Memosens Sensors: Configuring the Device .....	81
Replacing a Sensor.....	82
<b>Calibration</b> .....	<b>84</b>
Selecting a Calibration Mode .....	85
Zero Adjustment (ISFET).....	86
Automatic Calibration (Calimatic) .....	88
Manual Calibration with Buffer Entry .....	90
Data Entry of Premeasured Sensors .....	92
Product Calibration (pH).....	94
ORP (Redox) Calibration.....	96
Temp Probe Adjustment.....	98
<b>Measurement</b> .....	<b>99</b>
<b>Diagnostics</b> .....	<b>100</b>
<b>Service</b> .....	<b>105</b>

# Table of Contents

---

<b>Operating States</b> .....	<b>108</b>
<b>Maintenance and Repair</b> .....	<b>109</b>
<b>A201B/X: Supply Units and Connection</b> .....	<b>110</b>
<b>Product Line and Accessories</b> .....	<b>111</b>
<b>Specifications</b> .....	<b>112</b>
<b>Buffer Tables</b> .....	<b>117</b>
-U1- Specifiable Buffer Set .....	130
<b>Error Handling</b> .....	<b>133</b>
<b>Error Messages</b> .....	<b>134</b>
<b>Decommissioning</b> .....	<b>137</b>
Disposal.....	137
Returns .....	137
<b>Sensoface</b> .....	<b>138</b>
<b>HART: Typical Applications</b> .....	<b>141</b>
<b>FDA 21 CFR Part 11</b> .....	<b>142</b>
Electronic Signature – Passcodes .....	142
Audit Trail .....	142
<b>Index</b> .....	<b>143</b>

## **Always Read and Observe the Safety Instructions!**

The device is constructed in accordance with the latest technology and generally accepted safety rules and regulations.

Under certain circumstances, however, usage may pose risks to users or cause damage to the device.

Commissioning must be carried out by specialist personnel authorized by the operating company. If safe operation is not possible, the device must not be switched on or, if it is already on, must be switched off properly and secured against unintended operation.

Reasons to assume safe operation is not possible:

- the device shows visible damage
- failure to perform the intended function
- prolonged storage at temperature of below -30 °C/-22 °F or above 70 °C/158 °F
- severe transport stresses

Before recommissioning the device, a professional routine test must be performed. This test should be carried out by the manufacturer at its factory.

## **Intended Use**

Stratos Pro A201MSPH is a 2-wire device for pH/mV, ORP, and temperature measurement using Memosens sensors in industrial, environmental, food, and wastewater applications.

Stratos Pro A201X and the separately approved Ex sensor may be operated in Zone 0 / Division 1.

Stratos Pro A201B and the separately approved Ex sensor may be operated in Zone 2.

The defined rated operating conditions must be observed when using this product. They can be found in the Specifications chapter of this User Manual; see page 112.

# Safety

---

## **Function Check Mode (HOLD Function)**

After activating configuration, calibration, or service, Stratos Pro enters function check mode (HOLD).

The current outputs respond in accordance with the configuration.

Operations must not be carried out while Stratos Pro is in function check (HOLD) mode, as the system may behave unexpectedly and put users at risk.

## **Control Drawings**

If installing in hazardous locations, observe the information provided on the included Control Drawings.

## **Devices Not Intended for Use in Hazardous Locations**

Devices identified with an N in their product name must not be used in hazardous locations.

## **Configuration**

Replacing components may affect intrinsic safety. The modules are not intended to be replaced on devices in the Stratos Pro A201 product line.



## Housing and Mounting Options

- The sturdy molded enclosure is designed for IP66/IP67 / TYPE 4X Outdoor protection, is made of PBT glass fiber reinforced PC, and has the following dimensions: H 148 mm, W 148 mm, T 117 mm. Knockouts in the housing enable
- wall mounting (with sealing plugs to seal the housing)  
see page 14
- pipe mounting (Ø 40 ... 60 mm, □ 30 ... 45 mm)  
see page 15
- panel mounting (cutout 138 mm x 138 mm acc. to DIN 43700)  
see page 16

## Protective Hood (Accessory)

The protective hood, which is available as accessory, provides additional protection against direct weather exposure and mechanical damage; see page 15.

## Connection of Sensors, Cable Glands

For connecting the cables, the enclosure provides

- 3 knockouts for M20x1.5 cable glands
- 2 knockouts for ½" conduit

For quasi-stationary installations with Memosens sensors, we recommend using the M12 socket accessory (ZU0822) instead of a cable gland – which allows simple replacement of the sensor cable without opening the device.

## Sensors

The device has been designed for application with Memosens sensors.

# Introduction

---

## **Display**

Plain-text messages on a large, backlit LC display enable intuitive operation. You can specify which values are to be displayed in standard measuring mode (“Main Display;” see page 27).

## **Color-Coded User Interface**

The colored display backlighting indicates different operating states (e.g., alarm: red, HOLD mode: orange; see page 28). The display backlighting can be switched off; see page 78.

## **Diagnostic Functions**

“Sensocheck” automatically monitors the glass and reference electrodes; and the “Sensoface” function clearly indicates the sensor condition; see page 138.

## **Data Logger**

The internal logbook (TAN SW-A002) can handle up to 100 entries – up to 200 with AuditTrail (TAN SW-A003); see page 103.

## **Two Parameter Sets A, B**

The device provides two parameter sets that can be switched manually or via a control input for different process connections or different process conditions.

For an overview of parameter sets (original for copy), see page 42.

## **Password Protection**

Password protection (passcodes) for granting access rights during operation can be configured; see page 107.

## **Automatic Calibration with Calimatic**

You can choose from the most commonly used buffer solutions, see page 117.

A custom buffer set can also be entered; see page 130.

## Control Inputs (TAN SW-A005)

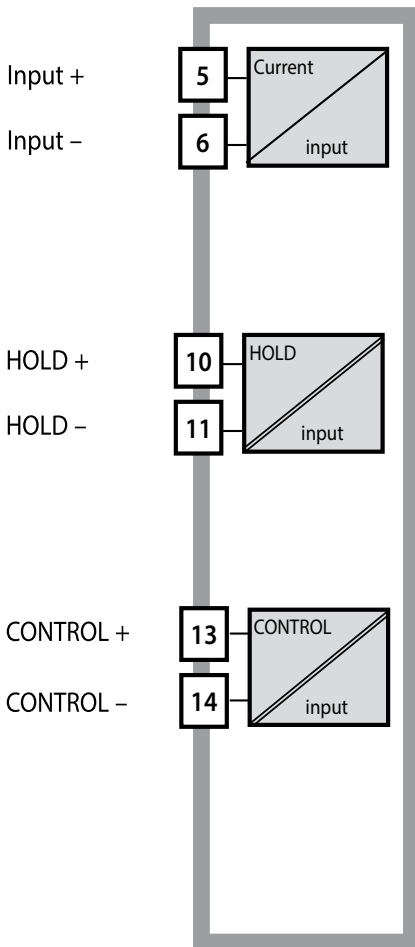

### I input

The analog (0) 4 ... 20 mA current input can be used for external temperature compensation; see page 68.

### HOLD

(Floating digital control input)

The HOLD input can be used for external activation of HOLD mode; see page 31.

### CONTROL

(Floating digital control input)

The CONTROL input can be used either for parameter set selection (A/B) or for flow monitoring; see page 70.

## Signal Outputs

The device provides two current outputs (for transmission of measured value and temperature, for example).

## Options

Additional functions can be enabled by entering a TAN (p. 107).

# Overview

## Overview of Stratos Pro A201MSPH

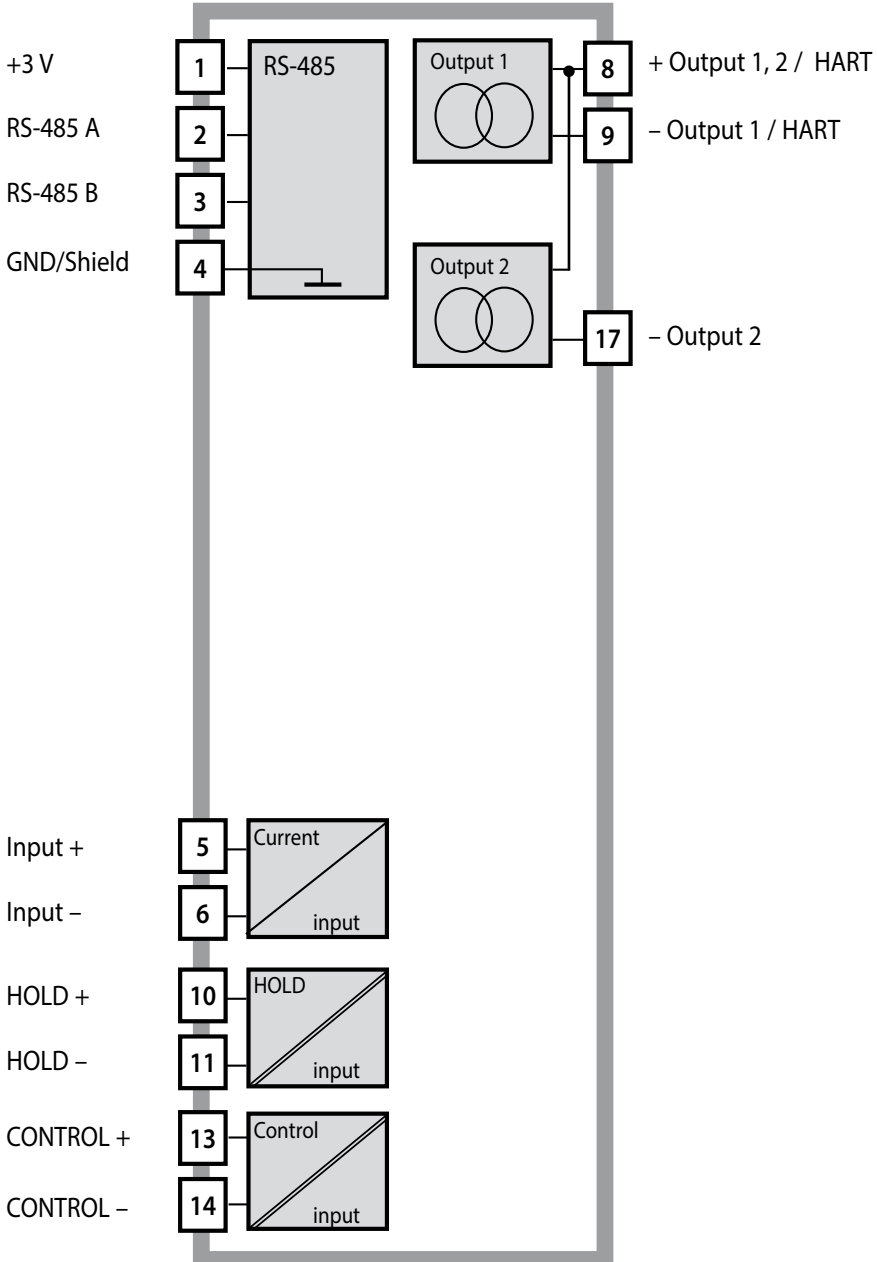

## Package Contents

**Note:** Check all components for damage upon receipt.  
Do not use damaged parts.

**The package should contain:**

- Front unit, rear unit, bag containing small parts
- Specific test report
- Documentation (see page 3)

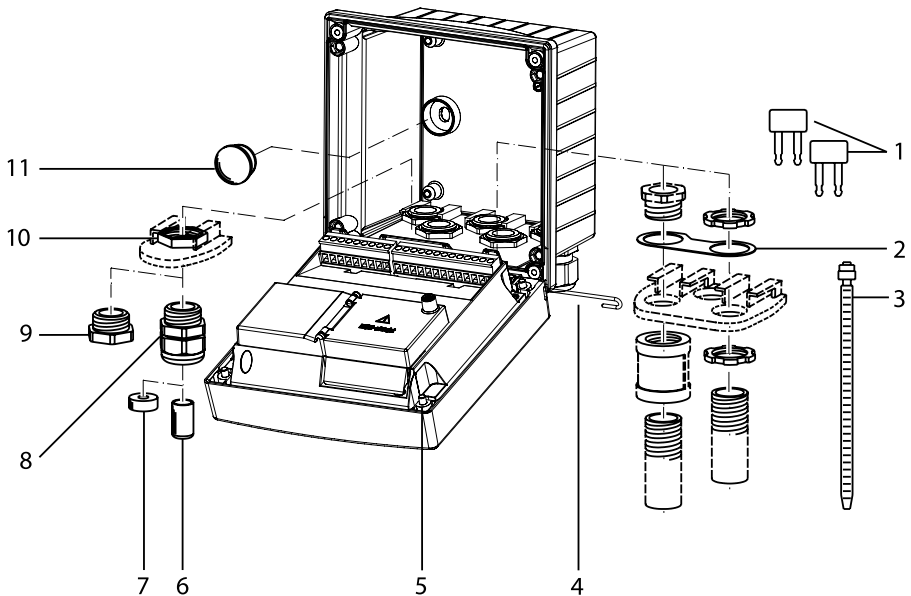

Fig.: Assembling the enclosure

- |  |   |
|--|---|
| 1) Insertable jumper (3x)  | 6) Blanking plug (2x, non-Ex only)                                  |
| 2) Plate (1x), for conduit mounting: Plate between housing and nut | 7) Reduction sealing insert (1x)                                    |
| 3) Cable tie (3x)  | 8) Cable gland (3x)   |
| 4) Hinge pin (1x), insertable from either side                     | 9) Blanking cap (2x)  |
| 5) Enclosure screw (4x)  | 10) Hex nut (5x)  |
|  | 11) Plastic sealing plug (2x), for sealing in case of wall mounting |

## Mounting Plan, Dimensions

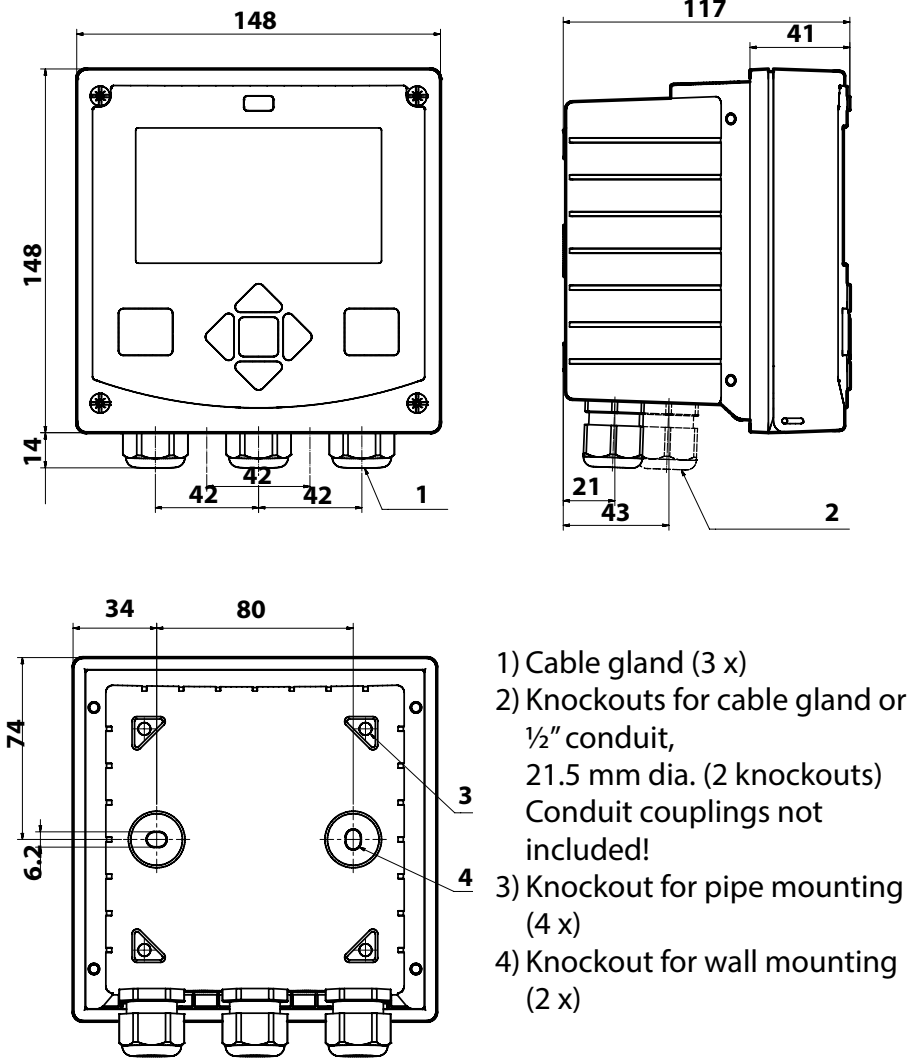
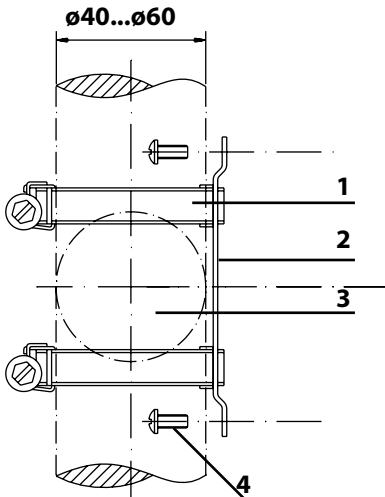

Fig.: Mounting plan (All dimensions in mm!)

## Pipe Mounting, Protective Hood



- 1) Hose clamp with worm gear drive to DIN 3017 (2 x)
- 2) Pipe-mount plate (1 x)
- 3) For vertical or horizontal posts or pipes
- 4) Self-tapping screw (4 x)

Fig.: Pipe-mount kit, accessory ZU 0274 (All dimensions in mm!)

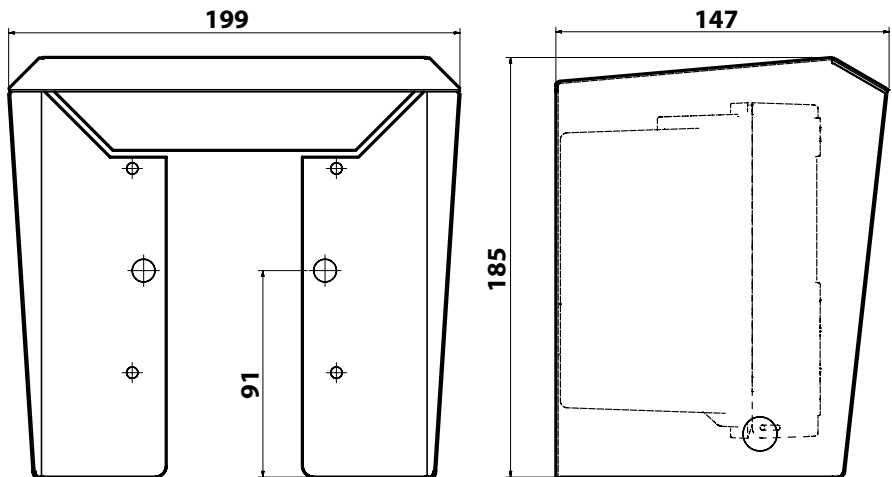
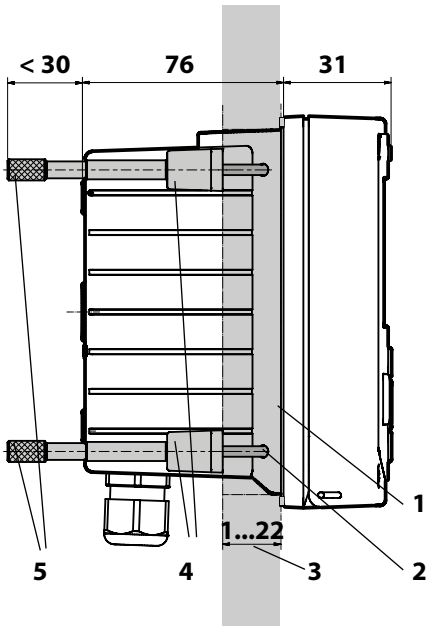

Fig.: Protective hood for wall and pipe mounting, accessory ZU 0737 (All dimensions in mm!)

## Panel Mounting



- 1) Circumferential sealing (1 x)
- 2) Screws (4 x)
- 3) Position of control panel
- 4) Span piece (4 x)
- 5) Threaded sleeve (4 x)

Cutout  
138 x 138 mm (DIN 43700)

Fig.: Panel-mount kit, accessory ZU 0738 (All dimensions in mm!)



# Electrical Installation

Before commencing with the installation, make sure that all lines to be connected are de-energized.

Observe the safety instructions; see page 7.

## Cable Glands

In a hazardous location, only cable glands with suitable approvals may be used. The installation instructions of the manufacturer must be observed.

Cable glands	5 cable glands M20 x 1.5 A/F 24 mm WISKA type ESKE/1 M20
Clamping ranges	Standard sealing insert: 7 ... 13 mm Reduction sealing insert: 4 ... 8 mm Multiple sealing insert: 5.85 ... 6.5 mm
Tensile strain	Not permitted; Only suitable for "fixed installation"

**⚠ CAUTION!** Risk of losing the specified ingress protection. Fasten the cable glands and screw together the housing correctly. Observe the permissible cable diameters and tightening torques. Only use original accessories and spare parts.

**NOTICE!** Strip the insulation from the wires using a suitable tool to prevent damage. For stripping length, see Specifications.

- 1) Wire the current outputs. Deactivate unused current outputs in the parameter settings or use jumpers.
- 2) Wire the inputs as necessary.
- 3) Connect the sensor.
- 4) Check whether all connections are correctly wired.
- 5) Close the housing and successively tighten the enclosure screws in a diagonal pattern.

## Rating Plates / Terminal Assignments

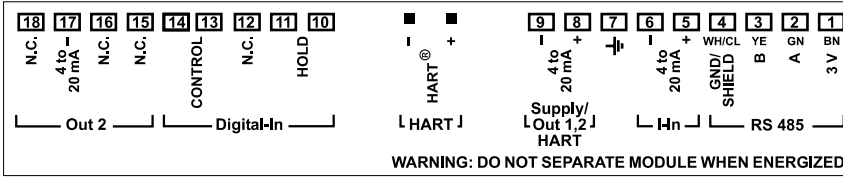

Fig.: Terminal assignments of Stratos Pro A2...

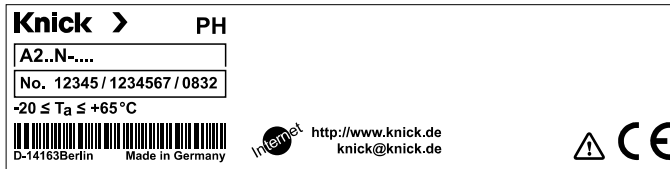
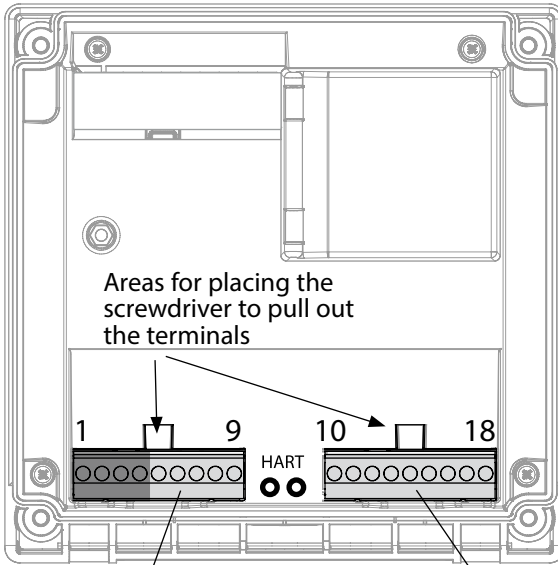

Fig.: Stratos Pro A2...N rating plate at outside bottom of front (illustrative example)

## Wiring of Stratos Pro A201 MSPH



Terminal row 1		
1 (BN)	+3V	⚠
2 (GN)	RS 485 A	⚠
3 (YE)	RS 485 B	⚠
4 (WH)	GND/shield	⚠
5	+ input	
6	- input	
7	PA	
8	+out 1,2/HART	
9	- out 1/HART	

Terminal row 2	
10	hold
11	hold
12	n.c.
13	contr
14	contr
15	n.c.
16	n.c.
17	- out 2
18	n.c.

In addition:

2 HART pins (between terminal row 1 and 2)

⚠ Sensor connection RS-485

Fig.: Terminals, device opened, back of front unit

# Connecting a Memosens Sensor

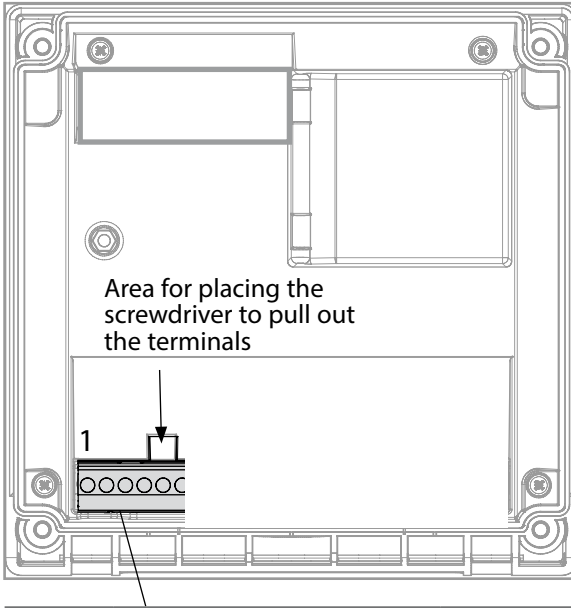

Memosens connection:		Wire color
1	+ 3 V	Brown
2	RS 485 A	Green
3	RS 485 B	Yellow
4	GND/shield	White, transparent shield

The Memosens sensor is connected to the RS-485 interface of the device. When the sensor is selected in the Configuration menu, the default values are taken as calibration data. They can then be modified by calibration.

**NOTICE! The measuring module slot must be empty!**

Stratos Pro A201MSPH is intended for connecting a Memosens sensor via RS-485 interface. It does not provide a measuring module.

# Wiring Examples

## Example 1:

Measuring task: pH/ORP, temp, glass impedance, ref. impedance

Sensors (example): SE 533/1-ADIN

Cable (example): CA/003-NAADIN11

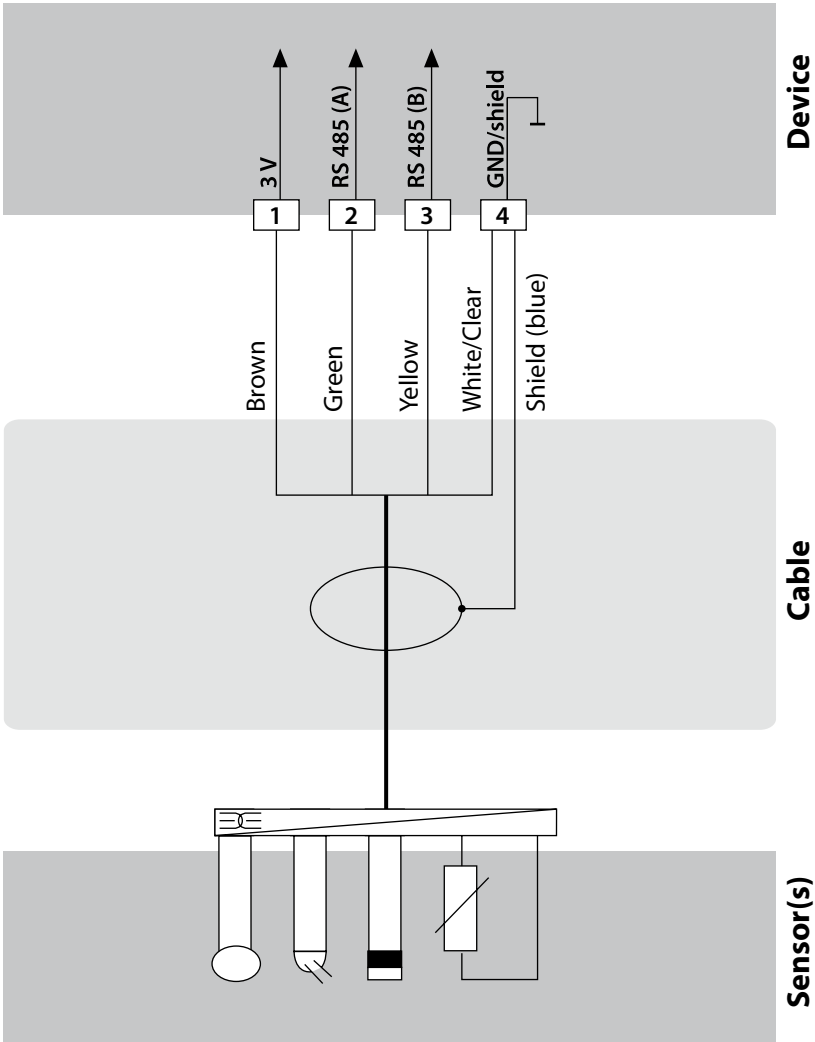

# Wiring Examples

## Example 2:

Measuring task: pH/ORP, temp, glass impedance

Sensors (example): SE531/1-NMSN

Cable (example): Memosens cable CA/MS-003NAA-L

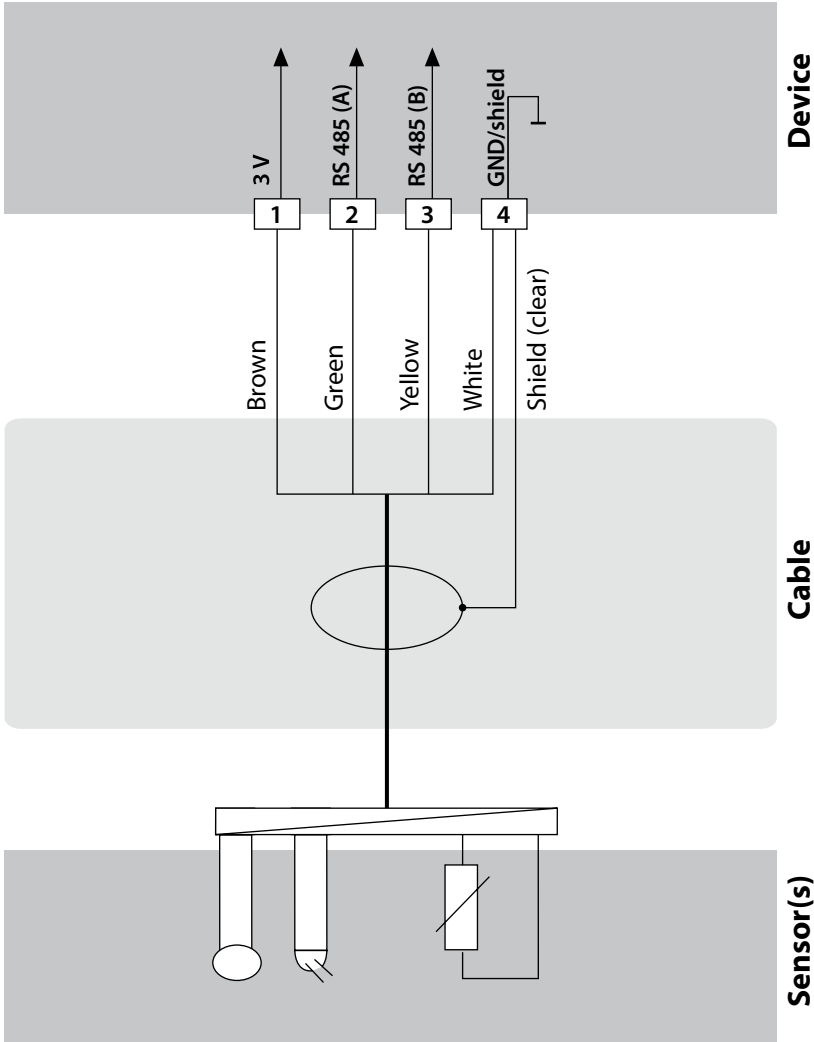

# User Interface, Keypad

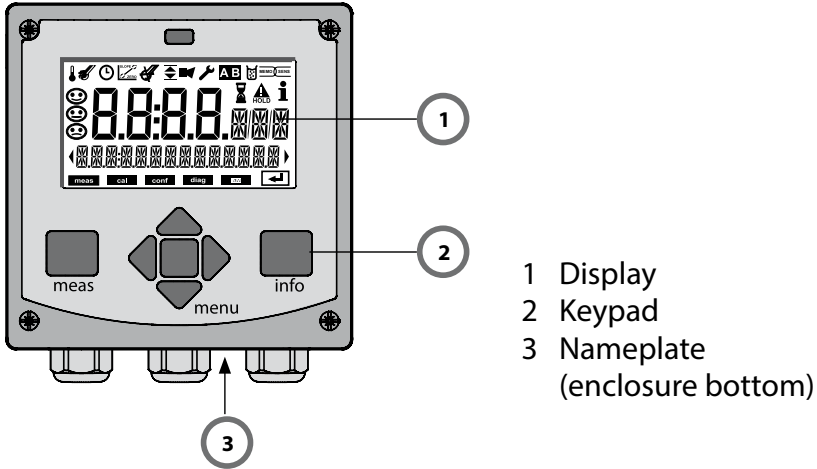

Key	Function
<b>meas</b>	<ul style="list-style-type: none"><li>• Return to last menu level</li><li>• Directly to measuring mode (press &gt; 2 s)</li><li>• Measuring mode: other display</li></ul>
<b>info</b>	<ul style="list-style-type: none"><li>• Retrieve information</li><li>• Show error messages</li></ul>
<b>enter</b>	<ul style="list-style-type: none"><li>• Configuration: Confirm entries, next configuration step</li><li>• Calibration: Continue program flow</li></ul>
<b>menu</b>	<ul style="list-style-type: none"><li>• Measuring mode: Call menu</li></ul>
<b>Arrow keys up / down</b>	<ul style="list-style-type: none"><li>• Menu: Increase/decrease a numeral</li><li>• Menu: Selection</li></ul>
<b>Arrow keys left / right</b>	<ul style="list-style-type: none"><li>• Previous/next menu group</li><li>• Number entry: Move between digits</li></ul>

# Display

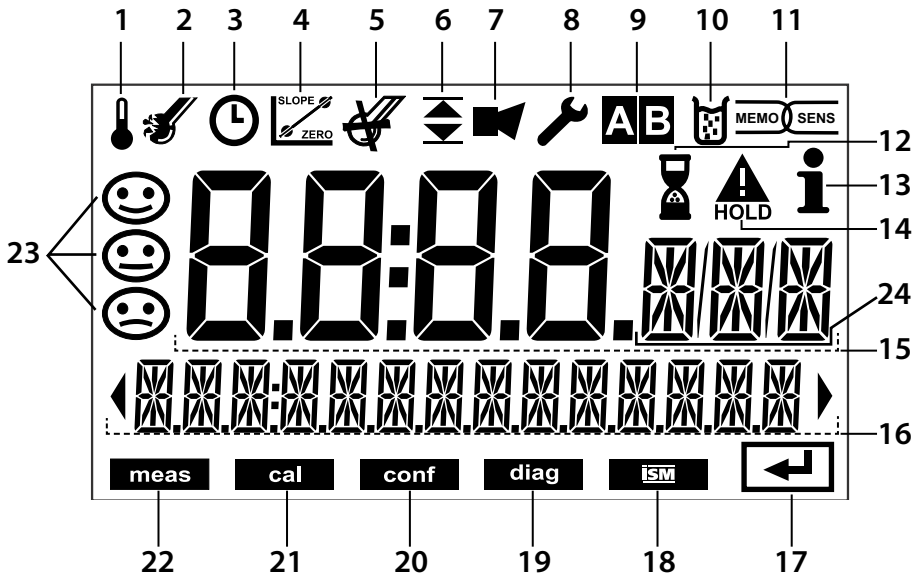

- |  |                        |
|--|------------------------|
| 1 Temperature                              | 13 Info available      |
| 2 Sensocheck                               | 14 Hold mode active    |
| 3 Interval/response time                   | 15 Main display        |
| 4 Sensor data                              | 16 Secondary display   |
| 5 Not used                                 | 17 Proceed using enter |
| 6 Limit message:<br>Limit 1 ▼ or Limit 2 ▲ | 18 ISM sensor          |
| 7 Alarm                                    | 19 Diagnostics         |
| 8 Service                                  | 20 Configuration mode  |
| 9 Parameter set                            | 21 Calibration mode    |
| 10 Calibration                             | 22 Measuring mode      |
| 11 Memosens sensor                         | 23 Sensoface           |
| 12 Waiting time running                    | 24 Unit symbols        |

## Signal Colors (Display Backlighting)

- |              |   |
|--------------|---|
| Red          | Alarm (in case of fault: display values blink)  |
| Red blinking | Input error: illegal value or wrong passcode    |
| Orange       | HOLD mode (Calibration, Configuration, Service) |
| Turquoise    | Diagnostics                                     |
| Green        | Info  |
| Magenta      | Sensoface message                               |



# Measuring Mode

After the operating voltage has been connected, the analyzer automatically goes to "Measuring" mode. To call the measuring mode from another operating mode (e.g. Diagnostics, Service): Hold **meas** key depressed (> 2 s).

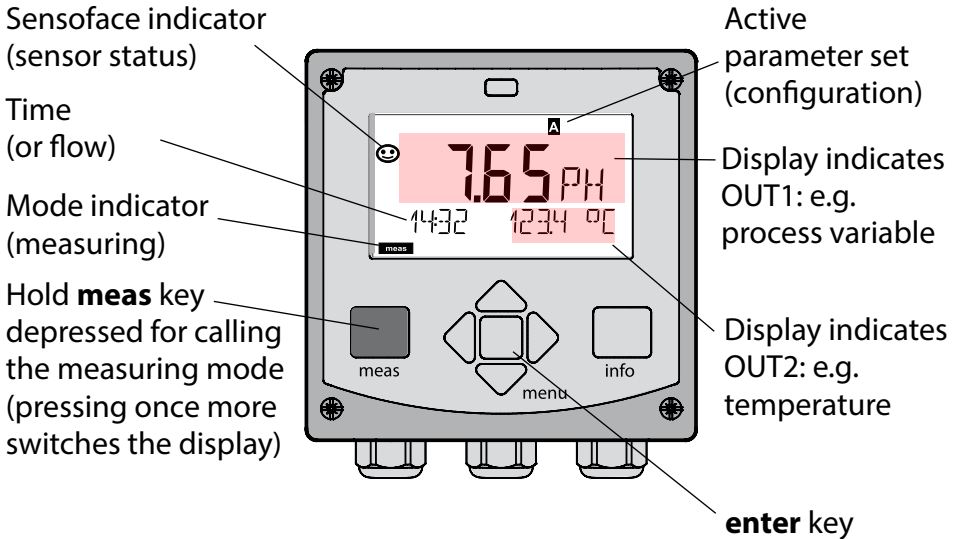

Depending on the configuration, one of the following displays can be set as standard display for the measuring mode (see page 27):

- Measured value, time and temperature (default setting)
- Measured value and selection of parameter set A/B or flow
- Measured value and tag number ("TAG")
- Time and date

**Note:** By pressing the **meas** key in measuring mode you can view the displays for approx. 60 sec.



The device must be configured for the respective measurement task, see page 34.

# Selecting the Mode / Entering Values

## To select the operating mode:

- 1) Hold **meas** key depressed (> 2 s) (directly to measuring mode)
- 2) Press **menu** key: the selection menu appears
- 3) Select operating mode using left / right arrow key
- 4) Press **enter** to confirm the selected mode

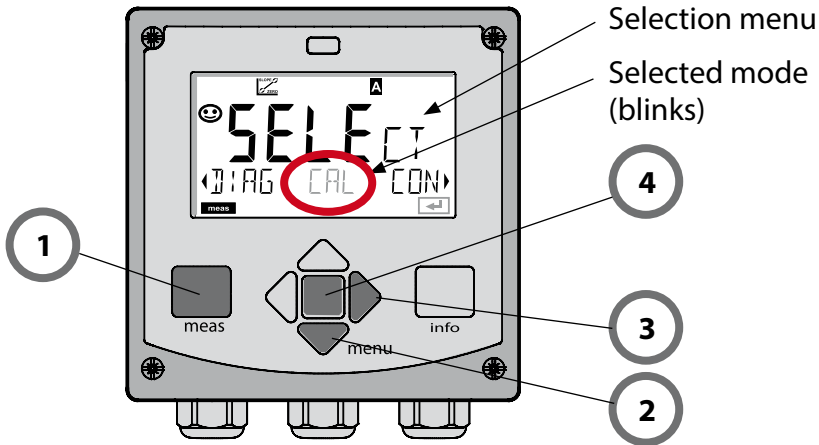

## To enter a value:

- 5) Select numeral: left / right arrow key
- 6) Change numeral: up / down arrow key
- 7) Confirm entry by pressing **enter**

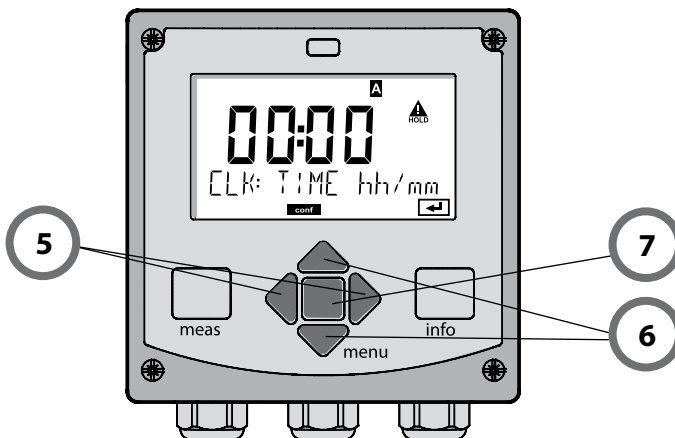

# Display in Measuring Mode

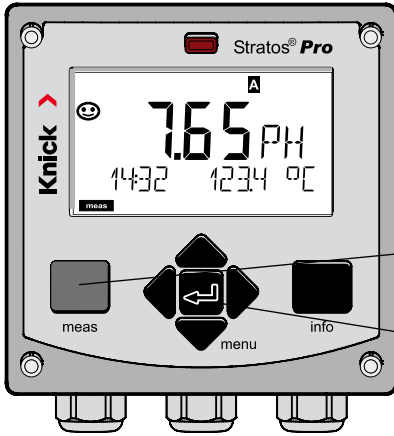

The MAIN DISPLAY is the display which is shown in measuring mode. To call the measuring mode from any other mode, hold the **meas** key depressed for at least 2 sec.

**meas** key

**enter** key

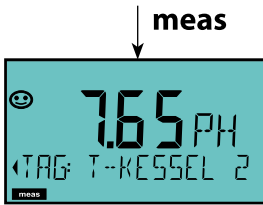

By pressing **meas** briefly you can step through further displays such as tag number (TAG) or flow (L/h). These displays are turquoise. After 60 sec they switch back to the main display.

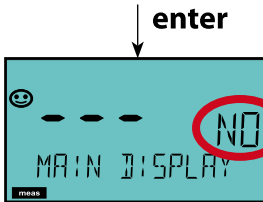
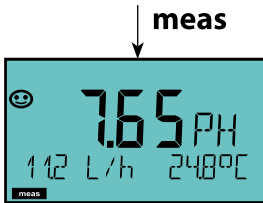

Press **enter** to select a display as MAIN DISPLAY – the secondary display shows “MAIN DISPLAY – NO”. Use the **UP / DOWN** arrow keys to select “MAIN DISPLAY – YES” and confirm by pressing **enter**. The display color changes to white. This display is now shown in measuring mode.

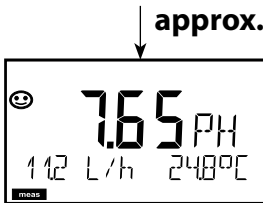

# Color-Coded User Interface

The color-coded user interface\* guarantees increased operating safety. Operating modes are clearly signaled. The normal measuring mode is white. Information text appears on a green screen and the diagnostic menu appears on turquoise.

The orange HOLD mode (e.g. during calibration) is quickly visible as is the magenta screen which indicates asset management messages for predictive diagnostics – such as maintenance request, pre-alarm and sensor wear.

The alarm status has a particularly noticeable red display color and is also signaled by flashing display values. Invalid inputs or false pass-codes cause the entire display to blink red so that operating errors are noticeably reduced.

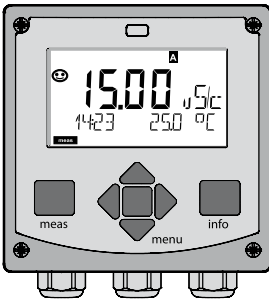

White:  
Measuring mode

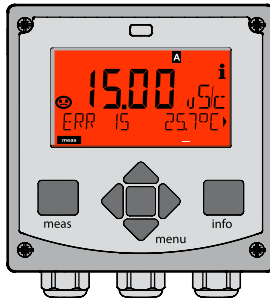

Red blinking:  
Alarm, errors

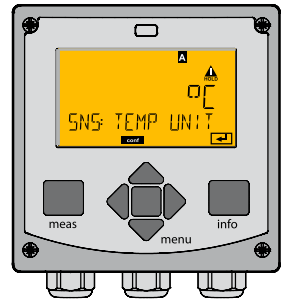

Orange:  
HOLD mode

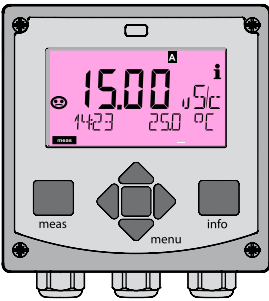

Magenta:  
Maintenance request

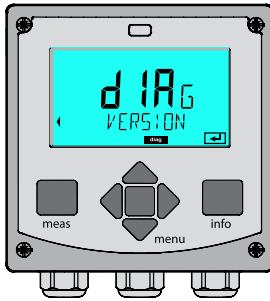

Turquoise:  
Diagnostics

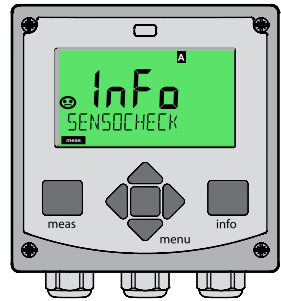

Green:  
Information texts

## **Diagnostics**

Display of calibration data, display of sensor data, performing a device self-test, viewing the logbook entries, display of hardware/software versions of the individual components. The logbook (TAN SW-A002) can store 100 events (00...99). They can be displayed directly on the device. Wit AuditTrail (TAN SW-A003), the logbook can be extended to 200 entries.

## **HOLD**

Manual activation of HOLD mode, e.g. for replacing a digital sensor. The signal outputs adopt a defined state.

## **Calibration**

Every sensor has typical characteristic values, which change in the course of the operating time. Calibration is required to supply a correct measured value. The device checks which value the sensor delivers when measuring in a known solution. When there is a deviation, the device can be "adjusted". In that case, the device displays the "actual" value and internally corrects the measurement error of the sensor. Calibration must be repeated at regular intervals. The time between the calibration cycles depends on the load on the sensor. During calibration the device is in HOLD mode.

**During calibration the device remains in the HOLD mode until it is stopped by the operator.**

## **Configuration**

The analyzer must be configured for the respective measurement task. In the "Configuration" mode you select the connected sensor, the measuring range to be transmitted, and the conditions for warning and alarm messages. During configuration the device is in HOLD mode.

**Configuration mode is automatically exited 20 minutes after the last keystroke. The device returns to measuring mode.**

## **Service**

Maintenance functions (monitor, current source), passcode assignment, reset to factory settings, enabling of options (TAN).

# Menu Structure of Modes and Functions

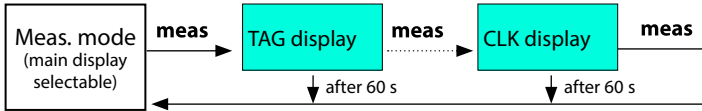

Pressing the **menu** key (down arrow) opens the selection menu. Select the menu group using the left/right arrow keys. Pressing **enter** opens a menu item. Press **meas** to return.

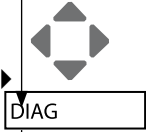

DIAG

CALDATA	Display of calibration data
SENSOR	Display of sensor data
SELFTEST	Self test: RAM, ROM, EEPROM, module
LOGBOOK	100 events with date and time
MONITOR	Display of measured values (mV_pH, mV_ORP, RTD, resistances of glass electrode, reference electrode)
VERSION	Display of software version, model designation, serial number

HOLD

Manual activation of HOLD mode, e.g. for sensor replacement. The signal outputs behave as configured (e.g. last measured value, 21 mA)

CAL

CAL_PH	pH adjustment (as configured)
CAL_ORP	ORP adjustment
P_CAL	Product calibration
ISFET-ZERO	Zero adjustment (for ISFET only)
CAL_RTD	Adjustment of temperature probe

CONF

PARSET A	Configuring parameter set A
PARSET B	Configuring parameter set B

SERVICE

(Access via code, factory setting: 5555)

MONITOR	Display of measured values for validation (simulators)
SENSOR	Reset TTM (for ISM), increment autoclaving counter
OUT1	Current source, output 1
OUT2	Current source, output 2
CODES	Specifying access codes for operating modes
DEFAULT	Reset to factory setting
OPTION	Enabling an option via TAN

# HOLD Mode

The HOLD mode is a safety state during configuration and calibration. Output current is frozen (LAST) or set to a fixed value (FIX). The HOLD mode is indicated by orange display backlighting.

**HOLD mode**, display icon:



## Output signal response

- **LAST:** The output current is frozen at its last value. Recommended for short configuration procedures. The process should not change decisively during configuration. Changes are not noticed with this setting!
- **FIX:** The output current is set to a value that is noticeably different from the process value to signal the control system that the device is being worked at.

## Output signal during HOLD:

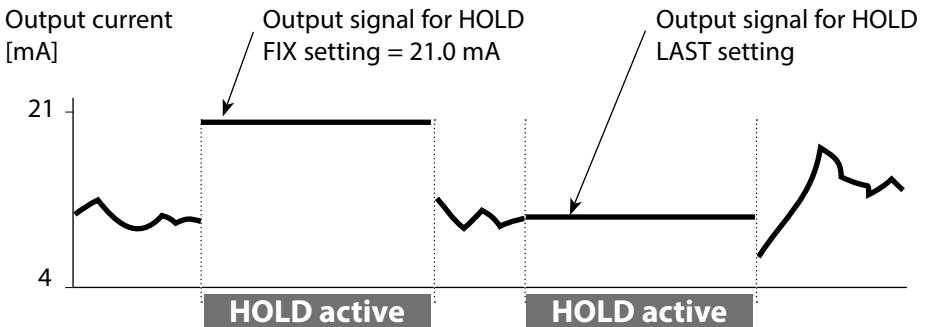

## Terminating the HOLD mode

The HOLD mode is ended by switching to measuring mode (hold **meas** key depressed). The display reads “Good Bye”, after that, the HOLD mode is exited.

When the calibration mode is exited, a confirmation prompt ensures that the installation is ready for operation (e.g.: sensor reinstalled, located in process).

# Alarm

## External activation of HOLD (TAN SW-A005)

The HOLD mode can be activated from outside by sending a signal to the HOLD input (e.g. from the process control system).

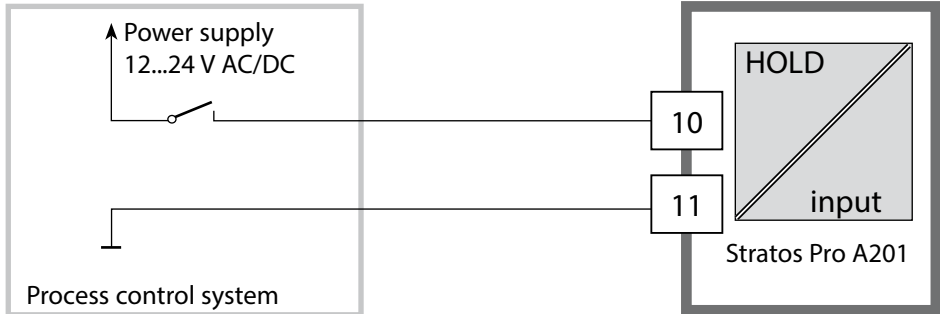

HOLD inactive	0...2 V AC/DC
HOLD active	10...30 V AC/DC

## Manual activation of HOLD

The HOLD mode can be activated manually from the HOLD menu. This allows checking or replacing a sensor, for example, without provoking unintended reactions at the outputs.

Press **meas** key to return to selection menu.

## Alarm

When an error has occurred, **Err xx** is displayed immediately.

Only after expiry of a user-defined delay time will the alarm be registered and entered in the logbook.

During an alarm the display blinks, the display backlighting turns **red**.

Error messages can also be signaled by a 22 mA output current (see Configuration).

2 sec after the failure event is corrected, the alarm status will be deleted.



# Alarm and HOLD Messages

Message	Released by	Cause
Alarm	Sensocheck	Polarization / Cable
(22 mA)	Error messages	Flow (CONTROL input)
HOLD	HOLD	HOLD via menu or input
(Last/Fix)	CONF	Configuration
	CAL	Calibration
	SERVICE	Service

## Generating a message via the CONTROL input (TAN SW-A005) (min. flow / max. flow)

The CONTROL input can be used for parameter set selection or for flow measurement (pulse principle), depending on its assignment in the “Configuration” menu.

When preset to flow measurement

**CONF/CNTR\_IN/CONTROL = FLOW**

an alarm can be generated when the measured flow exceeds a specified range:

**CONF/ALA/FLOW CNTR = ON**

**CONF/ALA/FLOW min** (specify value, default: 5 liters/h)

**CONF/ALA/FLOW max** (specify value, default: 25 liters/h)

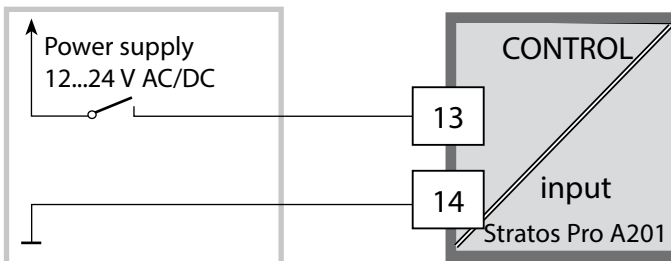

# Configuration

**⚠ CAUTION!** Incorrect parameter settings or adjustments can result in incorrect outputs. Stratos Pro must therefore be commissioned by a system specialist, all its parameters must be set, and it must be fully adjusted. For detailed information on parameter setting and adjustment, see the user manual

## Menu Structure of Configuration

The device provides 2 parameter sets "A" and "B". By switching between the parameter sets you can adapt the device to different measurement situations, for example. Parameter set "B" only permits setting of process-related parameters.

The configuration steps are assigned to different menu groups.

With the left/right arrow keys you can jump between the individual menu groups.

Each menu group contains menu items for setting the parameters.

Pressing **enter** opens a menu item. Use the arrow keys to edit a value.

Press **enter** to confirm/save the settings.

Return to measurement: Hold **meas** key depressed (> 2 s).

Select menu group	Menu group	Code	Display	Select menu item
	Sensor selection	SNS:		 enter  enter  enter  enter
		Menu item 1		
		⋮		
		Menu item ...		
▶	Current output 1	OT1:		
▶	Current output 2	OT2:		
▶	Compensation	COR:		
	...	...		
▶	Display backlighting	DSP:		

## Parameter Set A/B: Configurable Menu Groups

Menu group	Parameter set A	Parameter set B
SENSOR	Sensor selection	---
OUT1	Current output 1	Current output 1
OUT2	Current output 2	Current output 2
CORRECTION	Compensation	Compensation
CNTR_IN	Control input	---
ALARM	Alarm mode	Alarm mode
PARSET	Parameter set selection	---
CLOCK	Setting the clock	---
TAG	TAG of measuring point	TAG of measuring point
GROUP	GROUP of measuring points	GROUP of measuring points
DISPLAY	Display backlighting	---

# Configuration

## Parameter Set Selection

**Note:** Manual selection of parameter sets must have been preset in the CONFIG > PARSET menu. Default setting is a fixed parameter set A. Wrong settings change the measurement properties!

### Manual switchover of parameter sets A/B

Display	Action
	To switch between parameter sets: Press <b>meas.</b>
	PARSET blinks in the lower line. Select parameter set using ◀ and ▶ keys
	Press <b>enter</b> to confirm. Cancel by pressing <b>meas.</b>

### External switchover of parameter sets A/B (TAN SW-A005)

You can switch between parameter sets A and B by applying a signal to the CONTROL input (parameter setting: CONTR-IN > PARSET).

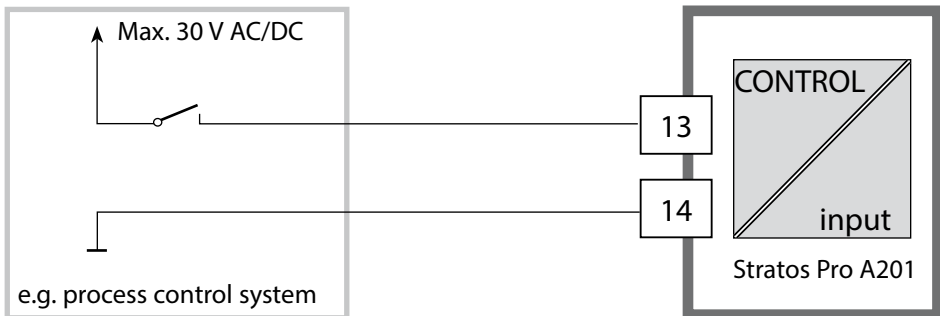

Parameter set A active	0...2 V AC/DC
Parameter set B active	10...30 V AC/DC

Configuration		Choices	Default
<b>Sensor (SENSOR)</b>			
SNS:		MEMOSENS, INDUCON	MEMOSENS
	TEMP UNIT	°C / °F	°C
	TEMP MEAS	AUTO, MAN, EXT (EXT. only with TAN option SW-A005)	AUTO
	MAN	-20...200 °C (-4...392 °F)	025.0 °C (077.0 °F)
	TEMP CAL	AUTO, MAN, EXT (EXT only with I-input enabled via TAN)	AUTO
	MAN	-20...200 °C (-4...392 °F)	025.0 °C (077.0 °F)
	CAL MODE	AUTO, MAN, DAT	AUTO
	AUTO BUFFER SET	-00-...-10-, -U1- <b>Note:</b> Pressing <b>info</b> displays nominal buffer values + manufacturer	-00-
	U1 (For specifiable buffer set, see Appendix: "Buffer Tables")	EDIT BUFFER 1 (NO, YES) Enter values for buffer 1	NO
		EDIT BUFFER 2 (NO, YES) Enter values for buffer 2	NO
	CAL TIMER	OFF, FIX, ADAPT	OFF
ON	CAL-CYCLE	0...9999 h	0168 h
Memosens	CIP COUNT	ON/OFF	OFF
	ON   CIP CYCLES	0...9999 CYC	0025 CYC
	SIP COUNT	ON/OFF	OFF
	ON   SIP CYCLES	0...9999 CYC	0025 CYC
	AUTOCLAVE	ON / OFF	OFF
	CHECK TAG/GROUP	ON / OFF	OFF

# Configuration

Configuration		Choices	Default
<b>Output 1 (OUT1)</b>			
OT1:	CHANNEL	PH/ORP/TMP	PH
PH	BEGIN 4 mA	-2.00...16 PH	00.00 PH
	END 20 mA	-2.00...16 PH	14.00 PH
ORP	BEGIN 4 mA	-1999...1999 mV	
	END 20 mA	-1999...1999 mV	
TMP °C	BEGIN 4 mA	-20...300 °C	Select °C / °F at "Sensor"
	END 20 mA	-20...300 °C	
TMP °F	BEGIN 4 mA	-4...572 °F	
	END 20 mA	-4...572 °F	
FILTERTIME		0...120 SEC	0000 SEC
22 mA FAIL		ON/OFF	OFF
22 mA FACE		ON/OFF	OFF
HOLD MODE		LAST/FIX	LAST
FIX	HOLD-FIX	04.00...22.00 mA	021.0 mA
<b>Output 2 (OUT2)</b>			
OT2:	CHANNEL	PH/ORP/TMP	TMP
PH	BEGIN 4 mA	-2.00...16 PH	00.00 PH
	END 20 mA	-2.00...16 PH	14.00 PH
ORP	BEGIN 4 mA	-1999...1999 mV	
	END 20 mA	-1999...1999 mV	
TMP °C	BEGIN 4 mA	-20...300 °C	Select °C / °F at "Sensor"
	END 20 mA	-20...300 °C	
TMP °F	BEGIN 4 mA	-4...572 °F	
	END 20 mA	-4...572 °F	
FILTERTIME		0...120 SEC	0000 SEC
22 mA FAIL		ON/OFF	OFF
22 mA FACE		ON/OFF	OFF
HOLD MODE		LAST/FIX	LAST
FIX	HOLD-FIX	04.00...22.00 mA	021.0 mA

Configuration		Choices	Default		
<b>Temperature compensation (CORRECTION)</b>					
COR:	TC SELECT	LIN / TC LIQUID	-19.99...19.99%/K	00.00%/K	
		USERTAB / EDIT TABLE	Table with 20 user-definable values, 5 °C step size		
	TEMP EXT*)		ON/OFF	OFF	
	ON	I-INPUT		0...20 mA/4...20 mA	4...20 mA
		°C	BEGIN 4 mA	-20...200 °C	000.0 °C
			END 20 mA	-20...200 °C	100.0 °C
		°F	BEGIN 4 mA	-4...392 °F	032.0 °F
		END 20 mA	-4...392 °F	212.0 °F	
<b>Control input (CNTR_IN)</b>					
IN:	CONTROL		Parameter-set switchover (PARSET) or flow measurement (FLOW)	PARSET	
	FLOW	FLOW ADJUST	12000 pulses/liter	0 ... 20000 pulses/liter	
<b>Alarm (ALARM)</b>					
ALA:	DELAYTIME		0...600 SEC	0010 SEC	
	SENSOCHECK		ON/OFF	OFF	
	FLOW CNTR **)		ON/OFF	OFF	
	ON	FLOW MIN **)		0 ... 99.9 L/h	005.0 L/h
		FLOW MAX**)		0 ... 99.9 L/h	025.0 L/h

\*) with TAN option SW-A005 and SENSOR "TEMP EXT" selected

\*\*\*) Hysteresis fixed at 5% of threshold value

# Configuration

Configuration		Choices	Default
<b>Parameter set (PARSET)</b>			
PAR:	Select fixed parameter set (A) or switch between A/B via control input or manually in measuring mode	PARSET FIX A / CNTR INPUT / MANUAL	PARSET FIX A (fixed parameter set A)
<b>Real-time clock (CLOCK)</b>			
CLK:	FORMAT	24 h / 12 h	24 h
	24 h	TIME hh/mm	00..23:00...59
	12 h	TIME hh/mm	00...11 AM/PM: 00...59
	DAY/MONTH		01...31/01...12
	YEAR		2000...2099
<b>Measuring points (TAG / GROUP)</b>			
TAG:	(Input in text line)	A...Z, 0...9, - + < > ? / @	
GROUP:	(Input in text line)	0000...9999	0000
<b>Display backlighting (DISPLAY)</b>			
DSP:	BACKLIGHT	On, Off	On



## **Support of Pfaudler Sensors**

This requires an additional function (TAN). The option is enabled in the SERVICE > OPT: PFAUDLER menu (see page 103).

When you use a Memosens Pfaudler sensor, the data will be read from the sensor or will be set to standard values. Here, you do not have to make entries. The respective menu items will be suppressed.

The nominal ZERO/SLOPE values are required for the proper functioning of the sensor monitoring and calibration functions (Sensoface, Calimatic), they do not replace an adjustment (calibration)!

### **Note:**

Please refer to the operating instructions of the respective sensor for more information on functioning, installation, calibration and configuration.

# Configuration (Template for Copy)

Parameters	Parameter set A	Parameter set B
SNS: Sensor type		--- *)
SNS: Temperature unit		---
SNS: Measurement temp		---
SNS: Manual meas. temp		---
SNS: Calibration temp		---
SNS: Manual cal temp		---
SNS: Calibration mode		---
SNS: Buffer set selection		---
SNS: Calibration timer		---
SNS: Calibration cycle		---
SNS: ISM adaptive cal timer (ACT)		---
SNS: ISM adaptive maintenance timer (TTM)		---
SNS: CIP counter		---
SNS: SIP counter		---
SNS: Autoclaving counter		---
SNS: CHECK TAG		---
SNS: CHECK GROUP		---
OT1: Process variable		
OT1: Current start		
OT1: Current end		
OT1: Filter time		
OT1: FAIL 22 mA (error messages)		
OT1: FACE 22 mA (Sensoface messages)		
OT1: HOLD mode		
OT1: HOLD FIX current		

## Configuration (Template for Copy)

Parameter	Parameter set A	Parameter set B
OT2: Process variable		
OT2: Current start		
OT2: Current end		
OT2: Filter time		
OT2: FAIL 22 mA (error messages)		
OT2: FACE 22 mA (Sensoface messages)		
OT2: HOLD mode		
OT2: HOLD FIX current		
COR: Temp coefficient		
COR: Ext. temp input		
COR: Current range		
COR: Current start		
COR: Current end		
IN: Parameter set A/B or flow		
IN: (Flow meter) Adjusting pulses/liter		
ALA: Delay		
ALA: Sensocheck on/off		
ALA: Flow control		
ALA: Minimum flow		
ALA: Maximum flow		
PAR: Parameter set selection		--- *)
CLK: Time format		---
TAG: Measuring point (tag number)		
GROUP: Group of measuring points		
DISPLAY: Display backlighting		---

\*) These parameters cannot be adjusted in parameter set B, the values are the same as in parameter set A.

# Configuration

## Sensor

Select: sensor type, temperature unit,  
temp detection during measurement

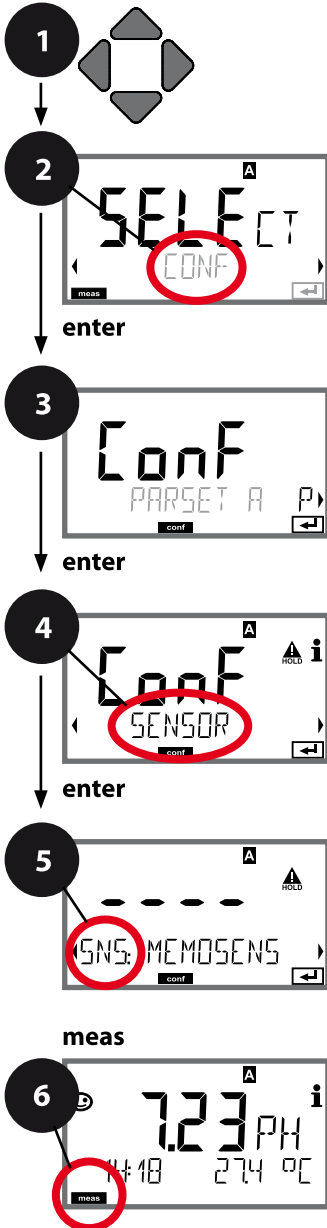

- 1) Press **menu** key.
- 2) Select **CONF** using ◀ ▶ keys, press **enter**.
- 3) Select parameter set using ◀ ▶, press **enter**.
- 4) Select **SENSOR** menu using ◀ ▶ keys, press **enter**.
- 5) All items of this menu group are indicated by the "SNS:" code.  
Press **enter** to select menu, edit using arrow keys (see next page). Confirm (and proceed) by pressing **enter**.
- 6) Exit: Press **meas** key until the [meas] mode indicator is displayed.

5	Select sensor type	enter
	Temperature unit	enter
	Temp detection during measurement	enter
	Temp detection during calibration	
	Calibration mode	
	(AUTO: Buffer set)	
	Calibration timer	
	Calibration cycle	
	CIP/SIP cycles	
	Autoclaving counter	
	CHECK TAG	
	CHECK GROUP	

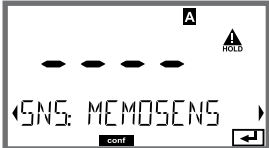
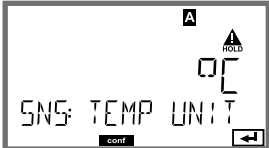
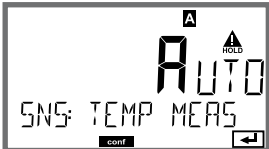
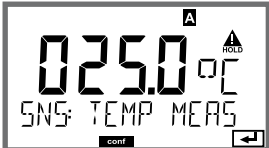
Menu item	Action	Choices
Select sensor type 	Select sensor type using ▲ ▼ keys.  Press <b>enter</b> to confirm.	<b>MEMOSENS</b> INDUCON
Temperature unit 	Select °C or °F using ▲ ▼ keys.  Press <b>enter</b> to confirm.	°C / °F
Temp detection during measurement 	Select mode using ▲ ▼ keys: AUTO: Measured by sensor MAN: Direct input of temperature, no measurement (see next step) EXT: Temperature specified via current input (only if TAN E enabled) Press <b>enter</b> to confirm.	<b>AUTO</b> MAN EXT
(Manual temperature) 	Modify digit using ▲ ▼ keys, select next digit using ◀ ▶ keys. Press <b>enter</b> to confirm.	-20...200 °C (-4...+392 °F)

# Configuration

## Sensor

### Select: temp detection during calibration, calibration mode

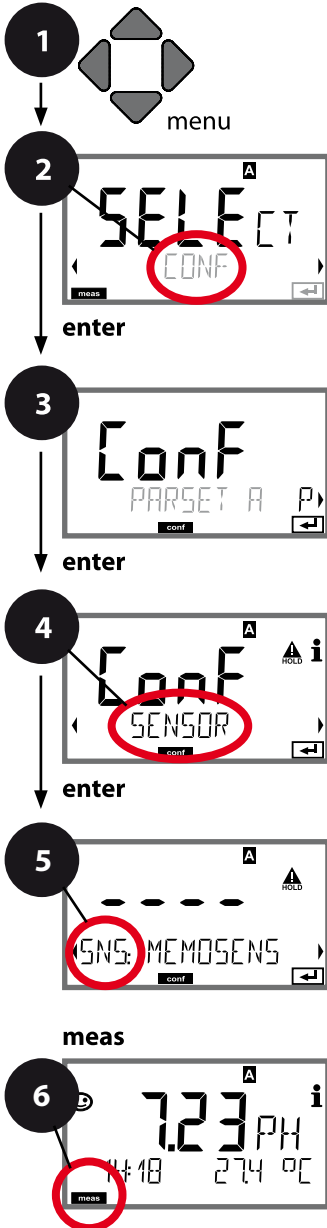

- 1) Press **menu** key.
- 2) Select **CONF** using ◀ ▶ keys, press **enter**.
- 3) Select parameter set using ◀ ▶, press **enter**.
- 4) Select **SENSOR** menu using ◀ ▶ keys, press **enter**.
- 5) All items of this menu group are indicated by the "SNS:" code.  
Press **enter** to select menu, edit using arrow keys (see next page). Confirm (and proceed) by pressing **enter**.
- 6) Exit: Press **meas** key until the [meas] mode indicator is displayed.

5

Select sensor type	enter
Temperature unit	enter
Temp detection during measurement	enter
Temp detection during calibration	
Calibration mode	
(AUTO: Buffer set)	
Calibration timer	
Calibration cycle	
CIP/SIP cycles	
Autoclaving counter	
CHECK TAG	
CHECK GROUP	

Menu item	Action	Choices
Temp detection during calibration	Select mode using ▲ ▼ keys: AUTO: Measured by sensor MAN: Direct input of temperature, no measurement (see next step) EXT: Temperature specified via current input (only if TAN E enabled) Press <b>enter</b> to confirm.	<b>AUTO</b> MAN EXT
(Manual temperature)	Modify digit using ▲ ▼ keys, select next digit using ◀ ▶ keys. Press <b>enter</b> to confirm.	-20...200 °C (-4...+392 °F)
Calibration mode	Select CALMODE using ▲ ▼ keys: AUTO: Calibration with Calimatic buffer set recognition MAN: Manual input of buffer solutions DAT: Input of adjustment data of premeasured sensors Press <b>enter</b> to confirm.	<b>AUTO</b> MAN DAT
(AUTO: Buffer set)	Select buffer set using ▲ ▼ keys (see buffer tables for nominal values). Press <b>enter</b> to confirm.	-00...-13-, (-U1-, see Appendix)  Pressing the <b>info</b> key displays the manufacturer and nominal values in the lower line.

# Configuration

## Sensor

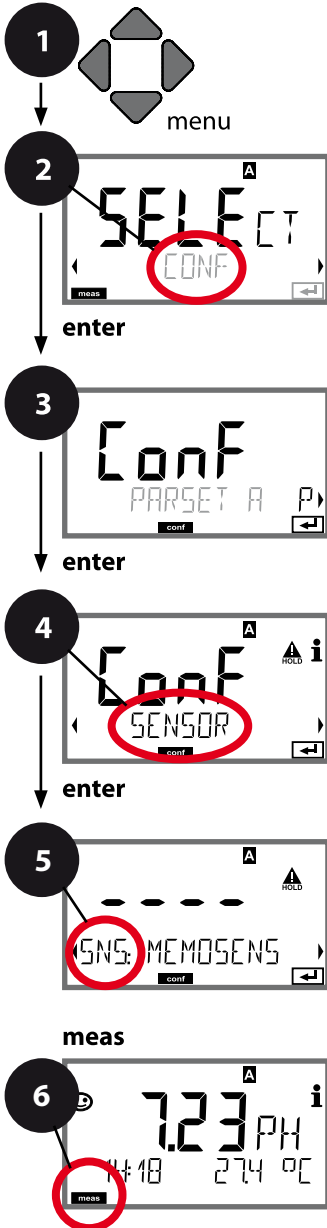

### Adjust: Cal timer, cal cycle



- 1) Press **menu** key.
- 2) Select **CONF** using ◀ ▶ keys, press **enter**.
- 3) Select parameter set using ◀ ▶, press **enter**.
- 4) Select **SENSOR** menu using ◀ ▶ keys, press **enter**.
- 5) All items of this menu group are indicated by the "SNS:" code.  
Press **enter** to select menu, edit using arrow keys (see next page). Confirm (and proceed) by pressing **enter**.
- 6) Exit: Press **meas** key until the [meas] mode indicator is displayed.





	5
Select sensor type	enter
Temperature unit	enter
Temp detection during measurement	
Temp detection during calibration	
Calibration mode	
(AUTO: Buffer set)	
Calibration timer	
Calibration cycle	
CIP/SIP cycles	
Autoclaving counter	
CHECK TAG	
CHECK GROUP	



Menu item	Action	Choices
Calibration timer 	Adjust CALTIMER using ▲ ▼ keys: OFF: No timer ADAPT: Maximum cal cycle (adjust in the next step) FIX: Fixed cal cycle (adjust in the next step) Press <b>enter</b> to confirm.	<b>OFF/ADAPT/FIX</b>  With ADAPT, the calibration cycle is automatically reduced depending on the sensor load (high temperatures and pH values) and for digital sensors also depending on the sensor wear
Calibration cycle 	Only with FIX/ADAPT: Modify digit using ▲ ▼ keys, select next digit using ◀ ▶ keys. Press <b>enter</b> to confirm.	0...9999 h

### Note for the calibration timer:

When Sensocheck has been activated in the Configuration – Alarm menu, the expiration of the calibration interval is indicated by Sensoface:

Display	Status
 + 	Over 80 % of the calibration interval has already past.
 + 	The calibration interval has been exceeded.

The calibration timer settings apply to both parameter sets A and B.

The time remaining until the next due calibration can be seen in the diagnostics menu (see Diagnostics chapter).

# Configuration

## Sensor

Adjust: CIP cleaning cycles, SIP sterilization cycles

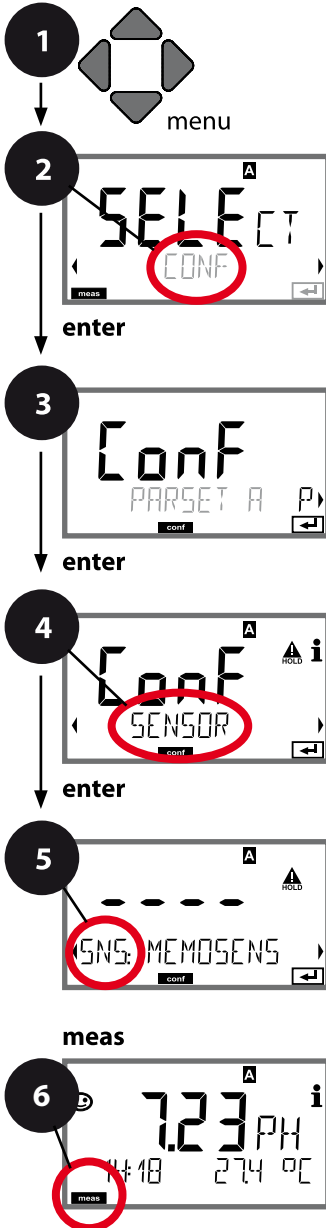

- 1) Press **menu** key.
- 2) Select **CONF** using ◀ ▶ keys, press **enter**.
- 3) Select parameter set using ◀ ▶, press **enter**.
- 4) Select **SENSOR** menu using ◀ ▶ keys, press **enter**.
- 5) All items of this menu group are indicated by the "SNS:" code.  
Press **enter** to select menu, edit using arrow keys (see next page). Confirm (and proceed) by pressing **enter**.
- 6) Exit: Press **meas** key until the [meas] mode indicator is displayed.

	5
Select sensor type	enter
Temperature unit	enter
Temp detection during measurement	enter
Temp detection during calibration	
Calibration mode	
(AUTO: Buffer set)	
Calibration timer	
Calibration cycle	
Cleaning cycle counter	
Cleaning cycles	
Sterilization cycle counter	
Sterilization cycles	
Autoclaving counter	
CHECK TAG	
CHECK GROUP	

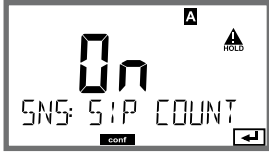
Menu item	Action	Choices
<b>CIP / SIP</b>		
Cleaning cycles	Select ON or OFF using ▲ ▼ keys. (Activates/deactivates logging.) Press <b>enter</b> to confirm. With pH/ORP combo sensors and CIP COUNT ON: Select CIP CYCLES and enter value (0000...9999) using ▲ ▼ ◀ ▶ keys. Press <b>enter</b> to confirm.	<b>ON/OFF</b>
		
Sterilization cycles	Select ON or OFF using ▲ ▼ keys. (Activates/deactivates logging.) Press <b>enter</b> to confirm. With SIP COUNT ON: Select SIP CYCLES and enter value (0000...9999) using ▲ ▼ ◀ ▶ keys. Press <b>enter</b> to confirm.	<b>ON/OFF</b>
		

Logging the cleaning and sterilization cycles with connected sensor helps measuring the load on the sensor.

Suitable for biochemical applications (process temp approx.

0 ... 50 °C / 32 ... 122 °F, CIP temp > 55 °C / 131 °F,

SIP temp > 115 °C / 239 °F).

**Note:**

A CIP or SIP cycle is only entered into the extended logbook (TAN SW-A003) 2 hours after the start to ensure that the cycle is complete.

# Configuration

## Sensor

### Adjust: Autoclaving counter

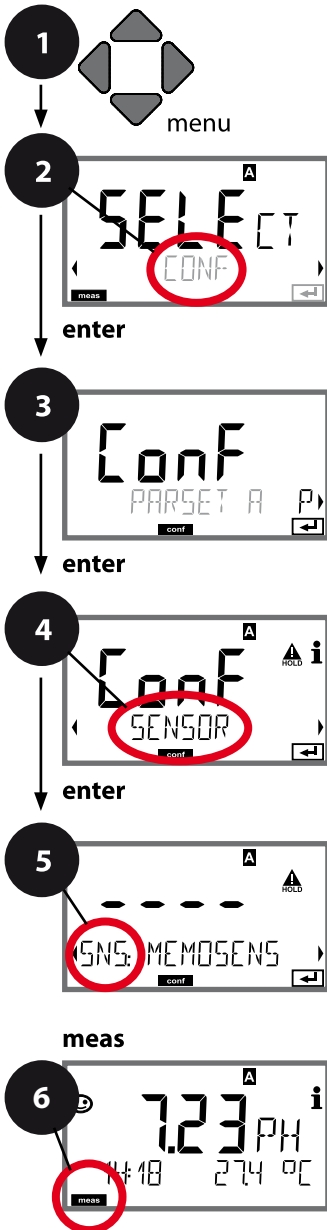



- 1) Press **menu** key.
- 2) Select **CONF** using ◀ ▶ keys, press **enter**.
- 3) Select parameter set using ◀ ▶ keys, press **enter**.
- 4) Select **SENSOR** menu using ◀ ▶ keys, press **enter**.
- 5) All items of this menu group are indicated by the "SNS:" code. Press **enter** to select menu, edit using arrow keys (see next page). Confirm (and proceed) by pressing **enter**.
- 6) Exit: Press **meas** key until the [meas] mode indicator is displayed.

Select sensor type	5	enter
Temperature unit		
Temp detection during measurement		
Temp detection during calibration		
Calibration mode		
(AUTO: Buffer set)		
Calibration timer		
Calibration cycle		
CIP/SIP cycles		
Autoclaving counter		
CHECK TAG		
CHECK GROUP		

## Autoclaving Counter

After reaching a specified limit value the autoclaving counter generates a Sensoface message. As soon as the counter has reached the specified value, Sensoface is getting “sad”. Pressing the info key shows the text “AUTOCLAVE CYCLES OVERRUN” which reminds you that the maximum number of autoclaving cycles has been reached. After each autoclaving process, you must manually increment the autoclaving counter in the SENSOR service menu on the transmitter. The transmitter displays “INCREMENT AUTOCLAVE CYCLE” as confirmation. You can configure the current outputs so that a Sensoface message generates a 22-mA error signal, see page 61.

Menu item	Action	Choices
<p><b>Autoclaving counter</b></p> 	<p>Select using ▲ ▼ keys: ON: The cycles are entered manually (0 ... 9999)  Press <b>enter</b> to confirm.</p>	<p><b>OFF/ON</b></p>
<p><b>Incrementing the autoclaving counter (SERVICE menu)</b></p> 	<p>After having completed an autoclaving process, open the SERVICE menu SENSOR &gt; AUTOCLAVE to increment the autoclaving count. To do so, select “<b>YES</b>” and confirm by pressing <b>enter</b>.</p>	<p><b>NO / YES</b></p>

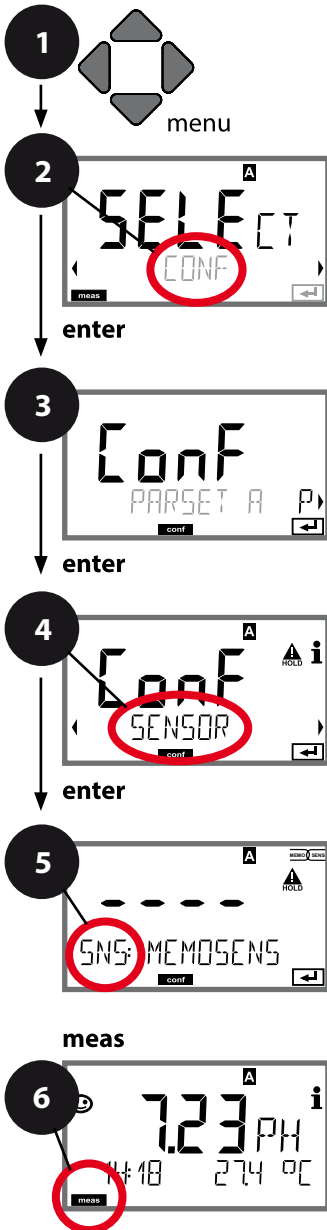

# Configuration

## Memosens Sensor Sensor Verification (TAG, GROUP)



- 1) Press **menu** key.
- 2) Select **CONF** using ◀ ▶, press **enter**.
- 3) Select parameter set using ◀ ▶ keys, press **enter**.
- 4) Select **SENSOR** menu using ◀ ▶ keys, press **enter**.
- 5) All items of this menu group are indicated by the "SNS:" code.  
Press **enter** to select menu, edit using arrow keys (see next page). Confirm (and proceed) by pressing **enter**.
- 6) Exit: Press **meas** key until the [meas] mode indicator is displayed.

Select sensor type	enter
Temperature unit	enter
Temp detection during measurement	enter
Temp detection during calibration	
Calibration mode	
(AUTO: Buffer set)	
Calibration timer	
Calibration cycle	
CIP/SIP cycles	
Autoclaving counter	
CHECK TAG	
CHECK GROUP	

Menu item	Action	Choices
<p>TAG</p> 	<p>Select ON or OFF using ▲ ▼ keys. Press <b>enter</b> to confirm.</p> <p>When switched on, the entry for "TAG" in the Memosens sensor is compared to the entry in the analyzer. If the entries differ, a message will be generated.</p>	<p>ON/OFF</p>
<p>GROUP</p> 	<p>Select ON or OFF using ▲ ▼ keys. Press <b>enter</b> to confirm.</p> <p>Function as described above</p>	<p>ON/OFF</p>

## Sensor Verification (TAG, GROUP)

When Memosens sensors are calibrated in the lab, it is often useful and sometimes even mandatory that these sensors will be operated again at the same measuring points or at a defined group of measuring points. To ensure this, you can save the respective measuring point (TAG) or group of measuring points (GROUP) in the sensor. TAG and GROUP can be specified by the calibration tool or automatically entered by the transmitter. When connecting an MS sensor to the transmitter, it can be checked if the sensor contains the correct TAG or belongs to the correct GROUP. If not, a message will be generated, Sensoface gets "sad", and the display backlighting turns purple (magenta). The "sad" Sensoface icon can also be signaled by a 22 mA error current. Sensor verification can be switched on in the Configuration in two steps as TAG and GROUP if required.

When no measuring point or group of measuring points is saved in the sensor, e.g., when using a new sensor, Stratos enters its own TAG and GROUP. When sensor verification is switched off, Stratos always enters its own measuring point and group. A possibly existing TAG/GROUP will be overwritten.

# Configuration

## Current Output 1

Output current range. Current start, Current end.

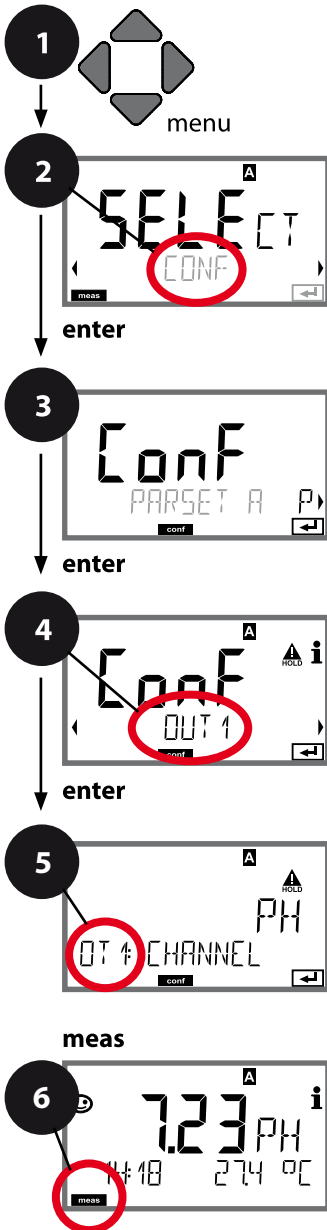



- 1) Press **menu** key.
- 2) Select **CONF** using ◀ ▶ keys, press **enter**.
- 3) Select parameter set using ◀ ▶ keys, press **enter**.
- 4) Select **OUT1** menu using ◀ ▶ keys, press **enter**.
- 5) All items of this menu group are indicated by the "OT1:" code.  
Press **enter** to select menu, edit using arrow keys (see next page). Confirm (and proceed) using **enter**.
- 6) Exit: Press **meas** key until the [meas] mode indicator is displayed.

5

Process variable	enter
Current start	enter
Current end	
Time averaging filter	
Output current for error message	
Output current for Sensoface	
Output current during HOLD	
Output current for HOLD FIX	

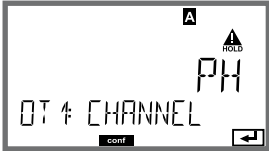

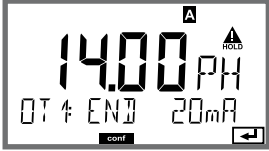
Menu item	Action	Choices
Process variable 	Select using ▲ ▼ keys: PH: pH value ORP: Redox potential RH: rH value (with pH/ORP sensor) TMP: Temperature Press <b>enter</b> to confirm.	<b>PH/ORP/RH/TMP</b>
Current start 	Modify digit using ▲ ▼ keys, select next digit using ◀ ▶ keys.  Press <b>enter</b> to confirm.	-2...16 pH (PH) -1999...1999 mV (ORP) -20...300 °C / -4...572 °F (TMP) 0 ... 42.5 rH
Current end 	Enter value using ▲ ▼ ◀ ▶ keys.  Press <b>enter</b> to confirm.	-2...16 pH (PH) -1999...1999 mV (ORP) -20...300 °C / -4...572 °F (TMP) 0 ... 42.5 rH

## Assignment of measured values: Current start and current end

Example 1: Range pH 0...14

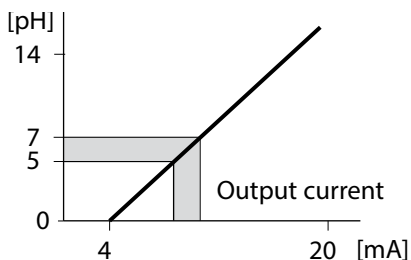

Example 2: Range pH 5...7

Advantage: Higher resolution in range of interest

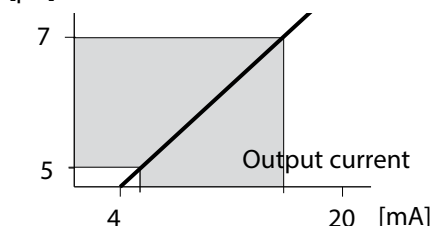

# Configuration

## Current Output 1

### Adjusting the time interval of the output filter

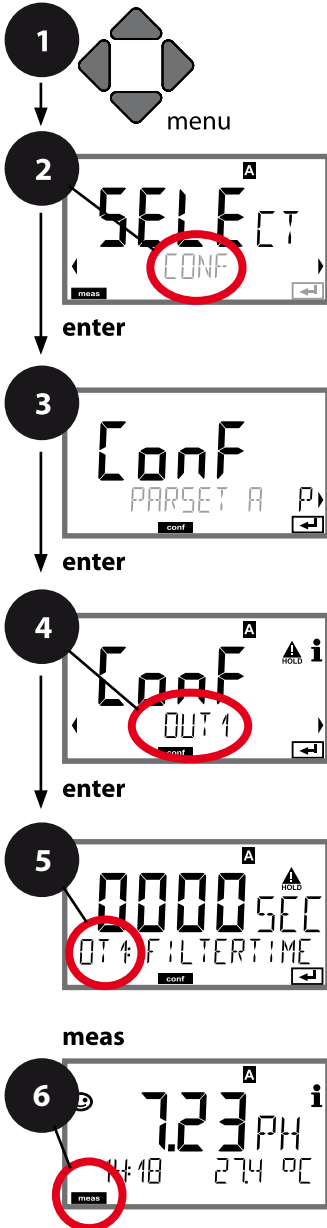

- 1) Press **menu** key.
- 2) Select **CONF** using ◀ ▶ keys, press **enter**.
- 3) Select parameter set using ◀ ▶ keys, press **enter**.
- 4) Select **OUT1** menu using ◀ ▶ keys, press **enter**.
- 5) All items of this menu group are indicated by the "OT1:" code.  
Press **enter** to select menu, edit using arrow keys (see next page). Confirm (and proceed) using **enter**.
- 6) Exit: Press **meas** key until the [meas] mode indicator is displayed.

	5
Process variable	enter
Current start	enter
Current end	
Time averaging filter	
Output current during error message	
Output current for Sensoface	
Output current during HOLD	
Output current for HOLD FIX	

Menu item	Action	Choices
Time averaging filter	Enter value using ▲ ▼ ◀ ▶ keys.  Press <b>enter</b> to confirm.	0...120 SEC <b>(0000 SEC)</b>

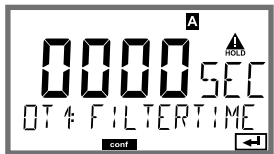

### Time averaging filter

To smoothen the current output, a low-pass filter with adjustable filter time constant can be switched on. When there is a jump at the input (100 %), the output level is at 63 % after the time interval has been reached. The time interval can be set from 0 to 120 sec. If the time interval is set to 0 sec, the current output directly follows the input.

#### Note:

The filter only acts on the current output, not on the display or the limit value!

During HOLD the filter is not applied. This prevents a jump at the output.

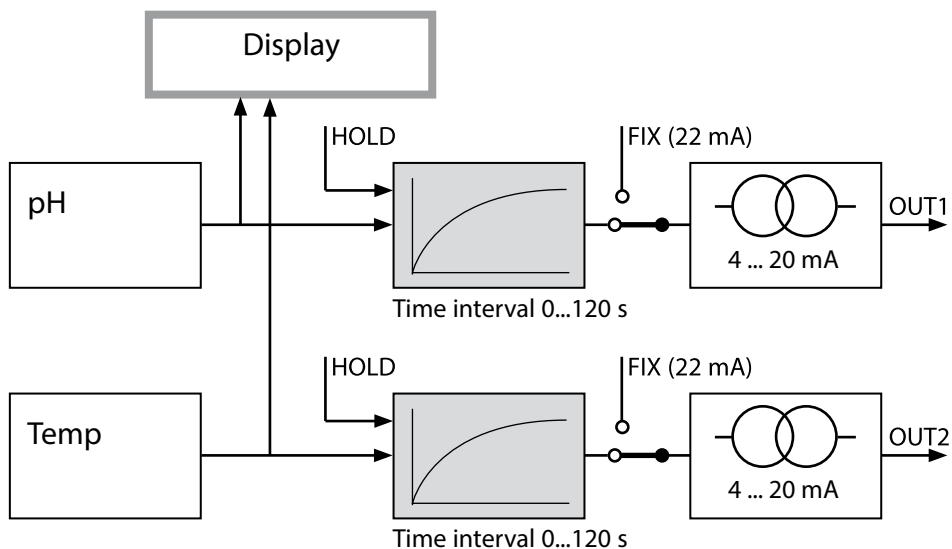

# Configuration

## Current Output 1

### Output current for error message or Sensoface alert

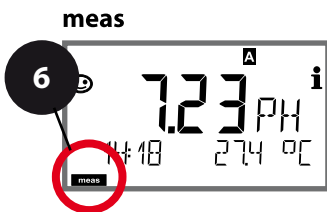
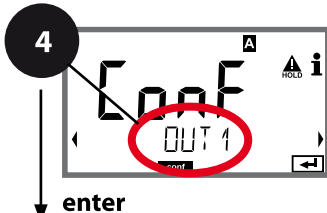
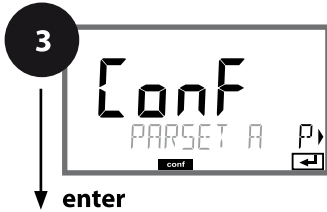
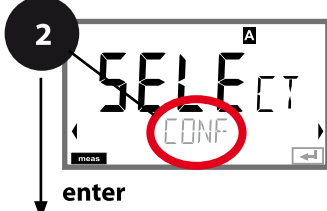
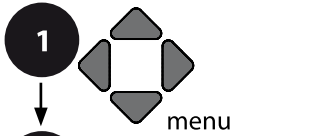

- 1) Press **menu** key.
- 2) Select **CONF** using ◀ ▶ keys, press **enter**.
- 3) Select parameter set using ◀ ▶ keys, press **enter**.
- 4) Select **OUT1** menu using ◀ ▶ keys, press **enter**.
- 5) All items of this menu group are indicated by the "OT1:" code.  
Press **enter** to select menu, edit using arrow keys (see next page). Confirm (and proceed) using **enter**.
- 6) Exit: Press **meas** key until the [meas] mode indicator is displayed.

5

Process variable	enter
Current start	enter
Current end	
Time averaging filter	
Output current for error message	
Output current for Sensoface	
Output current during HOLD	
Output current for HOLD FIX	

Menu item	Action	Choices
Output current for error message (FAIL)	In the case of an error (FAIL), the current output is set to 22 mA.  Select ON or OFF using ▲ ▼ keys. Press <b>enter</b> to confirm.	ON/OFF
Output current for Sensoface (FACE)	In the case of a Sensoface alert (FACE), the current output is set to 22 mA.  Select ON or OFF using ▲ ▼ keys. Press <b>enter</b> to confirm.	ON/OFF

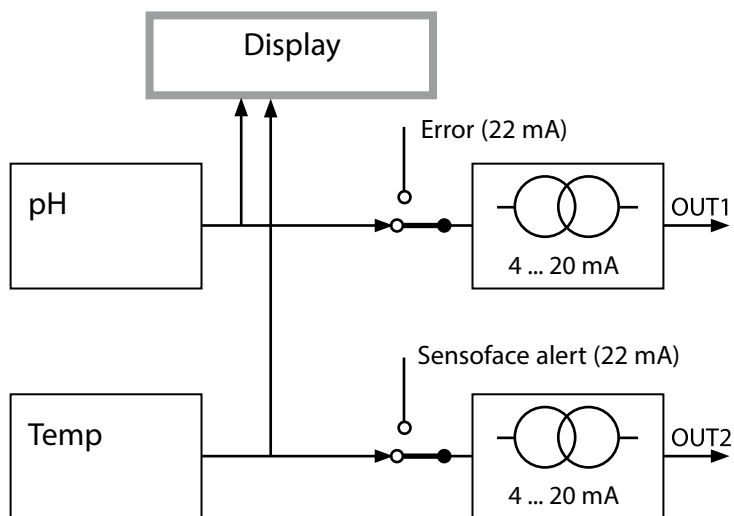

Error messages and Sensoface alerts can be set separately for both current outputs. This allows, for example, signaling error messages only over current output 1 and Sensoface alerts only over current output 2.

# Configuration

## Current Output 1 Output current during HOLD

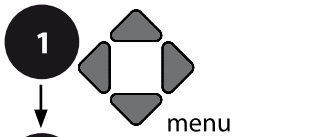

enter



enter

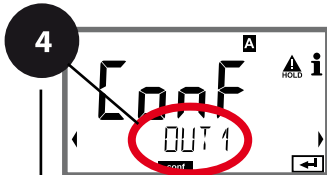

enter



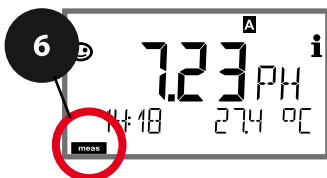

meas



- 1) Press **menu** key.
- 2) Select **CONF** using ◀ ▶ keys, press **enter**.
- 3) Select parameter set using ◀ ▶ keys, press **enter**.
- 4) Select **OUT1** menu using ◀ ▶ keys, press **enter**.
- 5) All items of this menu group are indicated by the "OT1:" code.  
Press **enter** to select menu, edit using arrow keys (see next page). Confirm (and proceed) by pressing **enter**.
- 6) Exit: Press **meas** key until the [meas] mode indicator is displayed.

5

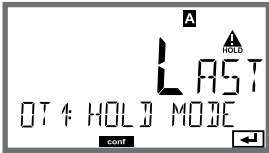
Process variable	enter
Current start	enter
Current end	
Time averaging filter	
Output current for error message	
Output current for Sensoface	
Output current during HOLD	
Output current for HOLD FIX	

Menu item	Action	Choices
Output current during HOLD 	LAST: During HOLD the last measured value is maintained at the output. FIX: During HOLD a value (to be entered) is maintained at the output. Select using ▲ ▼ Press <b>enter</b> to confirm.	<b>LAST/FIX</b>
Output current for HOLD FIX 	Only with FIX selected: Enter current which is to flow at the output during HOLD Enter value using ▲ ▼ ◀ ▶ keys.  Press <b>enter</b> to confirm.	00.00...22.00 mA <b>(21.00 mA)</b>

### Output signal during HOLD:

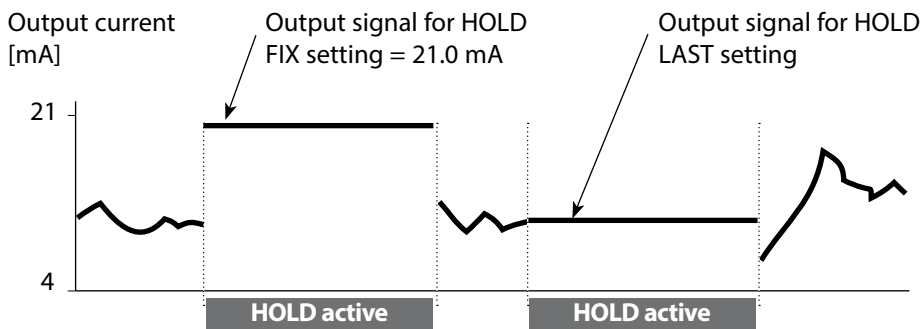

# Configuration

## Current Output 2

Process variable. Current start. Current end ...

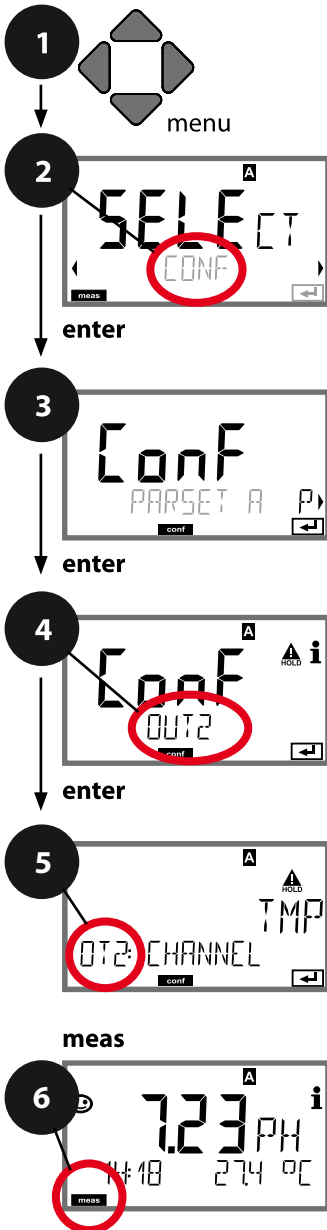

- 1) Press **menu** key.
- 2) Select **CONF** using ◀ ▶ keys, press **enter**.
- 3) Select parameter set using ◀ ▶ keys, press **enter**.
- 4) Select **OUT2** menu using ◀ ▶ keys, press **enter**.
- 5) All items of this menu group are indicated by the "OT2:" code.  
Press **enter** to select menu, edit using arrow keys (see next page). Confirm (and proceed) using **enter**.
- 6) Exit: Press **meas** key until the [meas] mode indicator is displayed.

Process variable
Current start
Current end
Time averaging filter
Output current for error message
Output current for Sensoface
Output current during HOLD
Output current for HOLD FIX



Menu item	Action	Choices
Process variable 	Select using ▲ ▼ keys: PH: pH value ORP: Redox potential RH: rH value (with pH/ORP sensor) TMP: Temperature Press <b>enter</b> to confirm.	PH/ORP/RH/TMP
<ul style="list-style-type: none"> <li>•</li> <li>•</li> <li>•</li> </ul>		

**All the following adjustments are made as for current output 1 (see there)!**

# Configuration

## Temperature Compensation

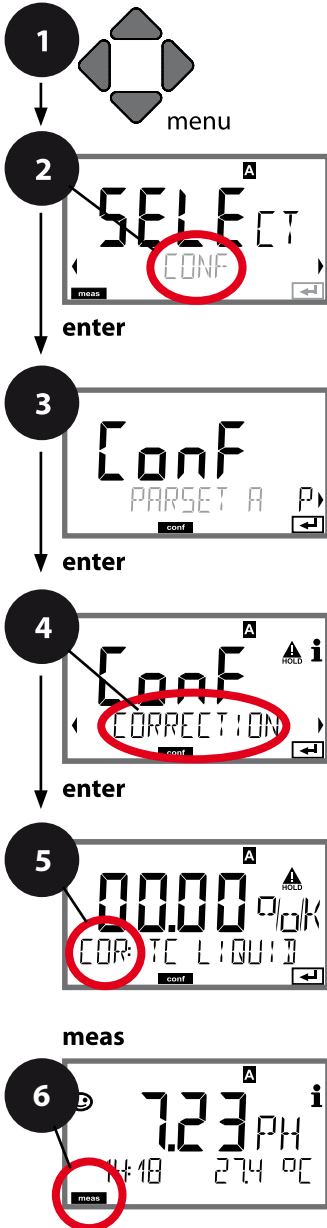

### TC process medium: Linear or user-definable table



- 1) Press **menu** key.
- 2) Select **CONF** using ◀ ▶ keys, press **enter**.
- 3) Select parameter set using ◀ ▶ keys, press **enter**.
- 4) Select **CORRECTION** menu using ◀ ▶ keys, press **enter**.
- 5) All items of this menu group are indicated by the "COR:" code.  
Press **enter** to select menu, edit using arrow keys (see next page). Confirm (and proceed) using **enter**.
- 6) Exit: Press **meas** key until the [meas] mode indicator is displayed.

5

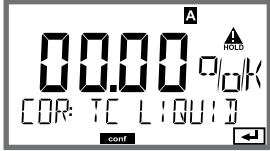
Temperature compensation for process medium (linear/table)	enter
Current input, external temp measurement	enter
Current range	enter
Current start	
Current end	

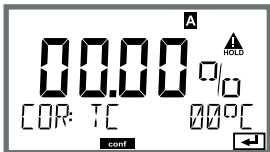
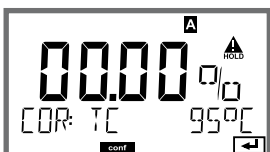
Menu item	Action	Choices
Temperature compensation, process medium 	For pH measurement only: Select temperature compensation of the process medium. Linear: LIN Table: USERTAB Select using ◀ ▶ key, confirm by pressing <b>enter</b> .	<b>OFF/LIN/USERTAB</b>
Temperature compensation, linear 	Enter the linear temperature compensation of the process medium. Enter value using ▲ ▼ ◀ ▶ keys. Press <b>enter</b> to confirm.	-19.99...+19.99 %/K
Temperature compensation, table 	When you have selected temperature compensation via table (USERTAB), you can enter values for a TC table from 0 to 95 °C in 5-K steps. The analyzer displays temperature values in 5 °C steps. You must specify the percent deviation of the measured value from each of these temperature values. Intermediate values are linearly interpolated. TC compensation can be defined separately for parameter sets A and B.	0 ... 95 °C (5°C step size)
Confirm safety prompt, then enter values (5°C step size)  		

# Configuration

## Temperature Compensation

### Current input, external temp measurement

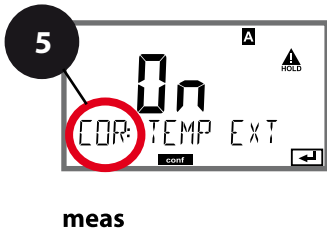
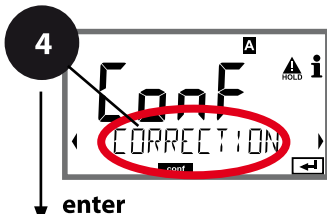
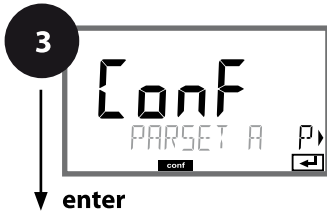
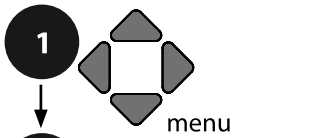

- 1) Press **menu** key.
- 2) Select **CONF** using ◀ ▶ keys, press **enter**.
- 3) Select parameter set using ◀ ▶ keys, press **enter**.
- 4) Select **CORRECTION** menu using ◀ ▶ keys, press **enter**.
- 5) All items of this menu group are indicated by the "COR:" code.  
Press **enter** to select menu, edit using arrow keys (see next page). Confirm (and proceed) using **enter**.
- 6) Exit: Press **meas** key until the [meas] mode indicator is displayed.

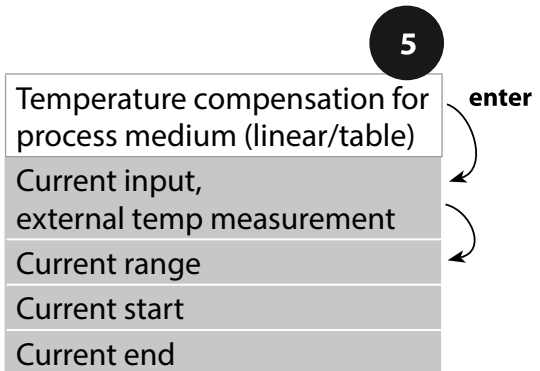

Menu item	Action	Choices
Current input, external temp measurement	<p>Only if enabled via TAN and selected during configuration (SENSOR). Select ON or OFF using ▲ ▼ keys.</p> <p>Press <b>enter</b> to confirm.</p>	<b>ON/OFF</b>
Current range	<p>Select desired range using ▲ ▼ keys.</p> <p>Press <b>enter</b> to confirm.</p>	<b>4-20 mA / 0-20 mA</b>
Current start	<p>Modify digit using ▲ ▼ keys, select next digit using ◀ ▶ keys.</p> <p>Press <b>enter</b> to confirm.</p>	Input range: -20...200 °C / -4...392 °F
Current end	<p>Enter value using ▲ ▼ ◀ ▶ keys.</p> <p>Press <b>enter</b> to confirm.</p>	Input range: -20...200 °C / -4...392 °F

# Configuration

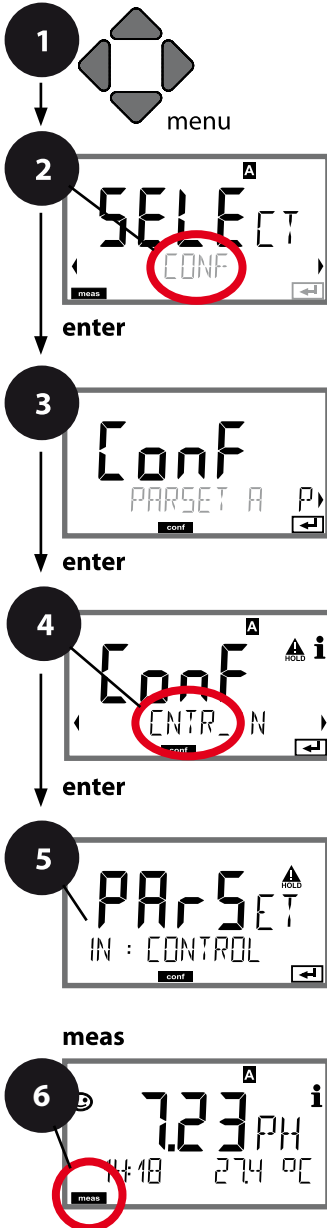

## CONTROL Input (TAN SW-A005)

### Parameter set selection via external signal or flow measurement

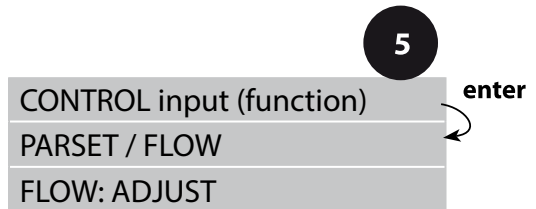

- 1) Press **menu** key.
- 2) Select **CONF** using ◀ ▶ keys, press **enter**.
- 3) Select parameter set using ◀ ▶, press **enter**.
- 4) Select **CNTR\_IN** menu using ◀ ▶ keys, press **enter**.
- 5) All items of this menu group are indicated by the "IN:" code.  
Press **enter** to select menu, edit using arrow keys (see next page). Confirm (and proceed) using **enter**.
- 6) Exit: Press **meas** key until the [meas] mode indicator is displayed.



Menu item	Action	Choices
Select function of CONTROL input 	Select using ▲ ▼ keys. Press <b>enter</b> to confirm.	<b>PARSET</b> (selecting parameter set A/B via signal at CONTROL input)
		Flow (for connecting a pulse-output flow meter)
Adjust to flow meter: 	<b>With "Flow" selected,</b> you must adjust the device to the flow meter used. Enter value using arrow keys. Press <b>enter</b> to confirm.	<b>12000 pulses/liter</b>

In the alarm menu you can configure flow monitoring. When you have set CONTROL to FLOW, you can specify 2 additional limit values for maximum and minimum flow.

If the measured value lies outside this range, an alarm message and a 22-mA error signal (if configured) will be generated.

### Display

Flow measurement in measuring mode



### Display

Flow measurement (sensor monitor)



# Configuration

## Alarm Settings

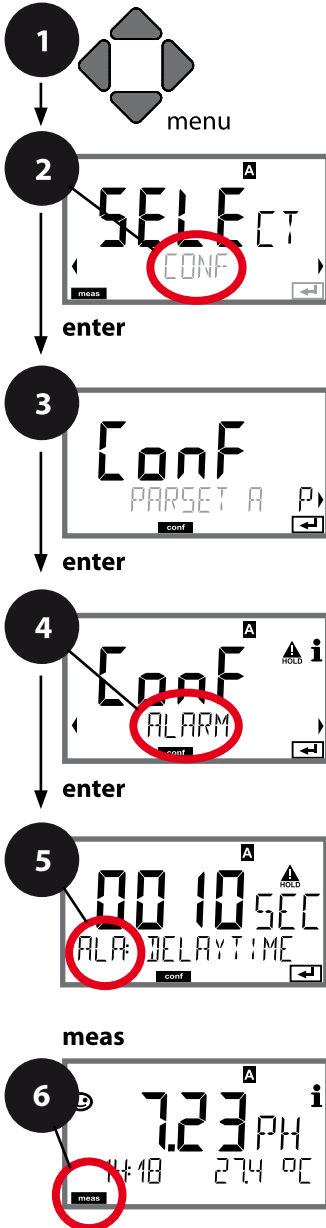

### Alarm delay. Sensocheck.



- 1) Press **menu** key.
- 2) Select **CONF** using ◀ ▶ keys, press **enter**.
- 3) Select parameter set using ◀ ▶, press **enter**.
- 4) Select **ALARM** menu using ◀ ▶ keys, press **enter**.
- 5) All items of this menu group are indicated by the "ALA:" code.  
Press **enter** to select menu, edit using arrow keys (see next page). Confirm (and proceed) using **enter**.
- 6) Exit: Press **meas** key until the [meas] mode indicator is displayed.

Delay	enter
Sensocheck	enter
CONTROL input	
For flow monitoring: Max. flow alarm	
For flow monitoring: Min. flow alarm	

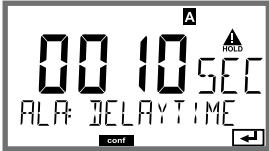

Menu item	Action	Choices
<p>Alarm delay</p> 	<p>Enter value using ▲ ▼ ◀ ▶ keys. Press <b>enter</b> to confirm.</p>	<p>0...600 SEC (010 SEC)</p>
<p>Sensocheck</p> 	<p>Select Sensocheck (continuous monitoring of glass and reference electrode) Select ON or OFF using ▲ ▼ keys. Press <b>enter</b> to confirm. (At the same time, Sensoface is activated. With OFF, Sensoface is also switched off.)</p>	<p>ON/OFF</p>

Error messages can be signaled by a 22 mA output current (see Error Messages and Configuration of Output 1/Output 2).

**The alarm delay time** delays the color change of the display backlighting to red and the 22 mA signal (if configured).

# Configuration

## Alarm Settings

### CONTROL input (TAN SW-A005)

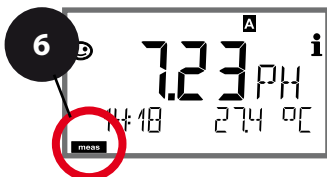
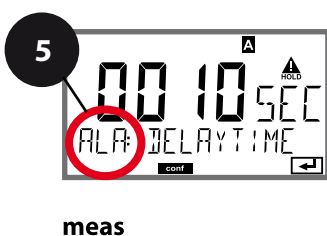
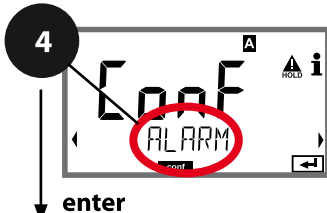
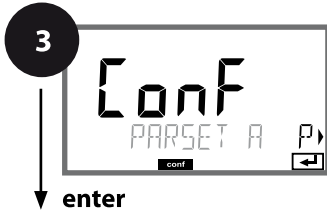
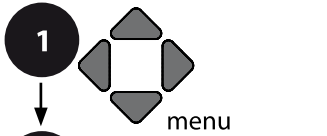

- 1) Press **menu** key.
- 2) Select **CONF** using ◀ ▶ keys, press **enter**.
- 3) Select parameter set using ◀ ▶, press **enter**.
- 4) Select **ALARM** menu using ◀ ▶ keys, press **enter**.
- 5) All items of this menu group are indicated by the "ALA:" code.  
Press **enter** to select menu, edit using arrow keys (see next page). Confirm (and proceed) using **enter**.
- 6) Exit: Press **meas** key until the [meas] mode indicator is displayed.

5

Delay	enter
Sensocheck	enter
CONTROL input	
For flow monitoring: Max. flow alarm	
For flow monitoring: Min. flow alarm	

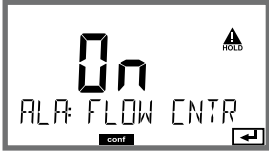
Menu item	Action	Choices
CONTROL input 	The <b>CONTROL input</b> can generate an alarm when assigned to FLOW (flow monitoring) in the CONF menu: <b>FLOW CNTR</b> <b>Flow measurement:</b> allows monitoring the minimum and maximum flow (pulse counter)	<b>ON/OFF</b>  (FLOW MIN, FLOW MAX.)
Alarm Minimum flow <b>FLOW MIN</b>	Specify value	Default: 05.00 liters/h
Alarm Maximum flow <b>FLOW MAX</b>	Specify value	Default: 25.00 liters/h

# Configuration

## Time and Date

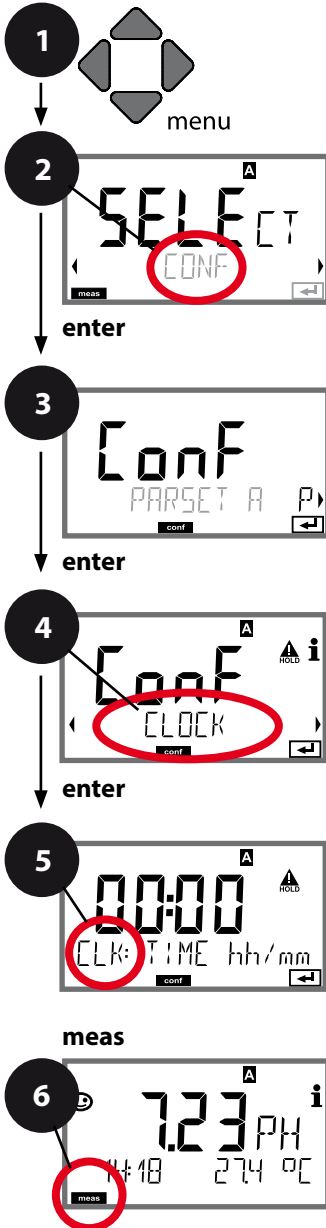

- 1) Press **menu** key.
- 2) Select **CONF** using ◀ ▶, press **enter**.
- 3) Select parameter set A using ◀ ▶ keys, press **enter**.
- 4) Select **CLOCK** using ◀ ▶ keys, press **enter**.
- 5) All items of this menu group are indicated by the "CLK:" code.  
Press **enter** to select menu, edit using arrow keys (see next page). Confirm (and proceed) by pressing **enter**.
- 6) Exit: Press **meas** key until the [meas] mode indicator is displayed.

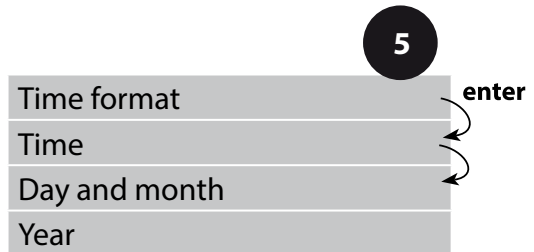

## **Time and Date**

Control of the calibration and cleaning cycles is based on the time and date of the integrated real-time clock.

In measuring mode the time is shown in the lower display. When using digital sensors, the calibration data is written in the sensor head. In addition, the logbook entries (cf Diagnostics) are provided with a time stamp.

### **Note:**

There is no automatic switchover from winter to summer time!

Be sure to manually adjust the time!

# Configuration

## Measuring Points (TAG/GROUP) Display Backlighting

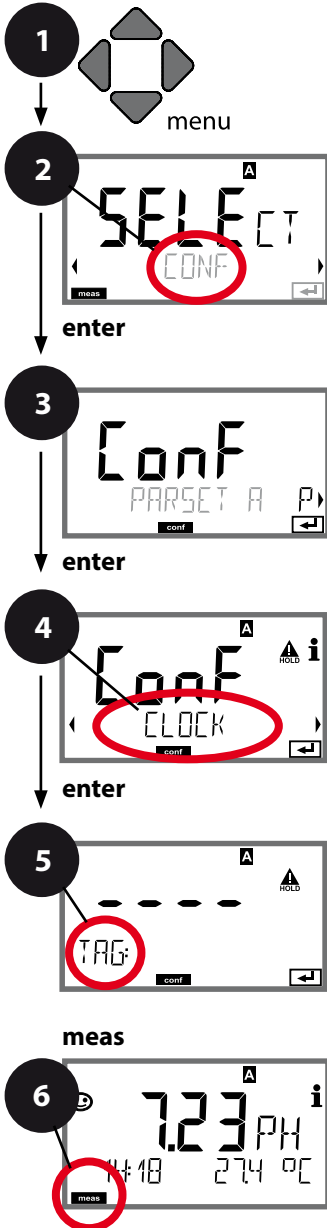

- 1) Press **menu** key.
- 2) Select **CONF** using ◀ ▶, press **enter**.
- 3) Select parameter set A using ◀ ▶ keys, press **enter**.
- 4) Select **TAG** or **DISPLAY** using ◀ ▶ keys, press **enter**.
- 5) All items of this menu group are indicated by the "TAG:" or "DSP" code. Press **enter** to select menu, edit using arrow keys (see next page). Confirm (and proceed) by pressing **enter**.
- 6) Exit: Press **meas** key until the [meas] mode indicator is displayed.

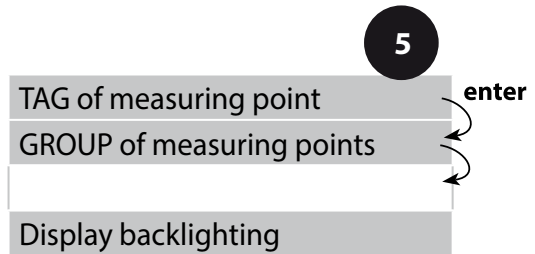

## Sensor Verification (TAG, GROUP)

When Memosens sensors are calibrated in the lab, it is often useful and sometimes even mandatory that these sensors will be operated again at the same measuring points or at a defined group of measuring points. To ensure this, you can save the respective measuring point (TAG) or group of measuring points (GROUP) in the sensor. TAG and GROUP can be specified by the calibration tool or automatically entered by the transmitter. When connecting an MS sensor to the transmitter, it can be checked if the sensor contains the correct TAG or belongs to the correct GROUP. If not, a message will be generated, Sensoface gets "sad", and the display backlighting turns purple (magenta). The "sad" Sensoface icon can also be signaled by a 22 mA error current. Sensor verification can be switched on in the Configuration in two steps as TAG and GROUP if required.

When no measuring point or group of measuring points is saved in the sensor, e.g., when using a new sensor, Stratos enters its own TAG and GROUP. When sensor verification is switched off, Stratos always enters its own measuring point and group. A possibly existing TAG/GROUP will be overwritten.

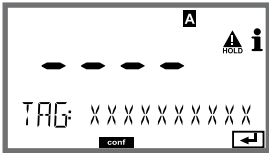
Menu item	Action	Choices
<p>Measuring point (TAG)</p> 	<p>In the lower display line you can enter a designation for the measuring point (TAG) and for a group of measuring points (GROUP) if applicable. Up to 32 digits are possible. Select character using ▲ ▼ keys, select next digit using ◀ ▶ keys. Press <b>enter</b> to confirm. By pressing <b>meas</b> (repeatedly) in the measuring mode you can view the tag number.</p>	<p>A...Z, 0...9, - + &lt; &gt; ? / @</p> <p>The first 10 characters are seen in the display without scrolling.</p>

## Switch Off the Display Backlighting

The display backlighting can be switched off in the DISPLAY menu.

**Note:** If the display backlighting is off, color signaling of error events is not possible.

# Digital Sensors

Stratos Pro can be operated with digital sensors. Due to the galvanic isolation of Memosens sensors, earth or ground potentials have no effect here. Therefore, a Solution Ground or measures for equipotential bonding are not required.

Digital sensors can be calibrated and maintained in the lab. This considerably simplifies on-site maintenance.

## Memosens Sensors: Calibration and Maintenance in the Lab

The “MemoSuite” software allows calibrating Memosens sensors under reproducible conditions at a PC in the lab. The sensor parameters are registered in a database. Documenting and archiving meet the demands of FDA CFR 21 Part 11. Detailed reports can be output as csv export for Excel.

The screenshot displays the MemoSuite software interface. At the top, there is a navigation bar with icons for StartCenter, Calibration, Table View, History, Statistics, and pH Buffers. The main area is divided into several sections:

- Measured values:** A table showing pH value (7.09 pH), pH voltage (49.2 mV), and Temperature (25.1 °C).
- Sensor data:** A panel showing details for the currently connected sensor: pH (glass), Manufacturer: KNICK, Order code: SE 533X/1-NM5N, Serial number: 1030550, Measuring point, and Tag number: 0.
- Adjustment data:** A panel showing calibration details: Date: 06/27/2011 20:09:12, Slope: 58.5 mV/pH, and Zero point: 7.06 pH.

Annotations and callouts provide additional context:

- Settings and specifications:** Points to the top-left corner of the interface.
- Currently connected sensor:** Points to the sensor information box at the top right, which includes Sensor type, Manufacturer, Order code, and Serial number.
- Function selection:** Points to the navigation bar, noting that the selected function is highlighted.
- Parameters of currently connected sensor:** Points to the Sensor data panel.
- Last calibration (adjustment):** Points to the Adjustment data panel.
- Display size of measured values:** Points to a magnified view of the pH value (7.09 pH) in a separate window, explaining that the display size changes to a magnifying glass when the cursor moves over a measured value.



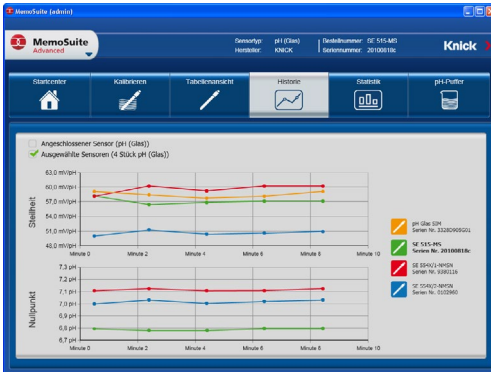

Calibration history of several sensors



History: Load diagrams of the sensors

## Memosens Sensors: Configuring the Device

The sensor type is selected during **Configuration**.

The device only switches to measuring mode when the connected sensor corresponds to the type configured (Sensoface is friendly):

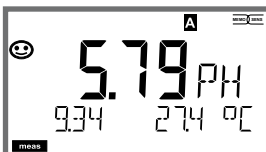

Otherwise, an error message is released. The **info** icon is displayed. You can display the error text in the bottom line using the ◀ ▶ keys.

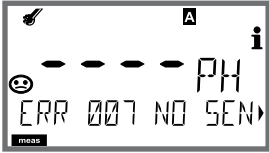
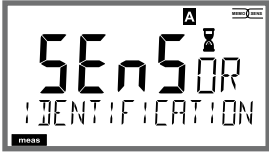
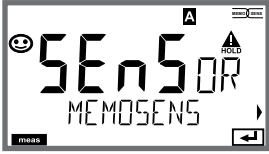

# Digital Sensors

## Connecting a Digital Sensor

Step	Action/Display	Remark
Connect sensor		Before a digital sensor is connected, the error message "No sensor" is displayed.
Wait until the sensor data are displayed.		The hourglass in the display blinks.
Check sensor data	 <p>View sensor information using ◀ ▶ keys, press <b>enter</b> to confirm.</p>	Display color changes to <b>green</b> .  Sensoface is friendly when the sensor data are okay.
Go to measuring mode	Press <b>meas</b> , <b>info</b> or <b>enter</b>	After 60 sec the device automatically returns to measuring mode (time-out).

## Replacing a Sensor

A sensor should only be replaced during HOLD mode to prevent unintended reactions of the outputs or contacts. When you first want to calibrate the new sensor, it can also be replaced in calibration mode.

Step	Action/Display	Remark
Select HOLD mode	Press <b>menu</b> key to call the selection menu, select HOLD using the ◀ ▶ keys, press <b>enter</b> to confirm.	Now the device is in HOLD mode. The HOLD mode can also be activated externally via the HOLD input. During HOLD the output current is frozen at its last value or set to a fixed value.
Disconnect old sensor, connect new sensor.		Temporary messages are displayed during the replacement but neither output to the alarm contact nor entered in the logbook.
Wait until the sensor data are displayed.		
Check sensor data	 <p>View sensor information using ◀ ▶ keys, press <b>enter</b> to confirm.</p>	You can view the sensor manufacturer and type, serial number, and last calibration date.
Check measured values, then exit HOLD.	Hit <b>meas</b> key: Return to the selection menu. Hold <b>meas</b> key depressed: Device switches to measuring mode.	The sensor replacement is entered in the extended logbook.

# Calibration

---

## Note:

- All calibration procedures must be performed by trained personnel. Incorrectly set parameters may go unnoticed, but change the measuring properties.
- The response time of the sensor and temperature probe is considerably reduced when the sensor is first moved about in the buffer solution and then held still.
- The device can only operate properly when the buffer solutions used correspond to the configured set. Other buffer solutions, even those with the same nominal values, may demonstrate a different temperature response. This leads to measurement errors.

**When using ISFET sensors or sensors with a zero point other than pH 7**, the nominal zero point must be adjusted each time a new sensor is connected. This is important if you want to obtain reliable Sensoface messages. The Sensoface messages issued during all further calibrations are based on this basic calibration.

# Selecting a Calibration Mode

Calibration is used to adapt the device to the individual sensor characteristics, namely asymmetry potential and slope. Access to calibration can be protected with a passcode (SERVICE menu).

First, you open the calibration menu and select the calibration mode:

CAL_PH	Depending on configuration setting: AUTO Automatic buffer recognition (Calimatic) MAN Manual buffer input DAT Input of premeasured electrode data
CAL_ORP	ORP calibration
P_CAL	Product calibration (calibration with sampling)
ISFET-ZERO	Zero adjustment. Required for ISFET sensors, subsequently you can conduct either a one or a two-point calibration.
CAL_RTD	Temperature probe adjustment

## To preset CAL\_PH (CONF menu / configuration):

- 1) Hold **meas** key depressed (> 2 s) (measuring mode)
- 2) Press **menu** key: the selection menu appears
- 3) Select CONF mode using left / right arrow key
- 4) Select "SENSOR" – "CALMODE": AUTO, MAN, or DAT.  
Press **enter** to confirm

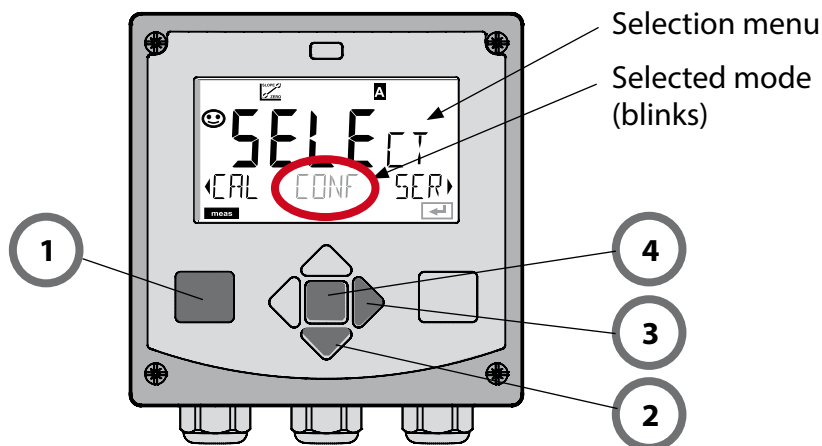





## Zero Adjustment (ISFET)

This adjustment allows the use of ISFET sensors with differing nominal zero (pH only). The function is available when Sensor selection = MEMOSENS has been set during configuration. Zero adjustment is disabled for any other sensors.

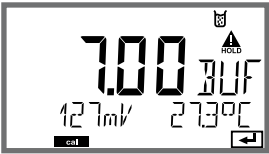

The adjustment is made using a zero buffer (pH 7.00).

Permitted range for buffer value: pH 6.5 ... 7.5.

Temperature-corrected input. Maximum zero offset:  $\pm 200$  mV.

Display	Action	Remark
 The display shows 'CAL' in large digits, 'ISFET-ZERO' below it, and a small 'cal' indicator at the bottom left. There are arrow keys on the left and right sides.	Select Calibration. Press <b>enter</b> to proceed.	
 The display shows 'CAL' in large digits, 'ISFET-ZERO' below it, and a small 'cal' indicator at the bottom left. An hourglass icon is visible in the top right corner, and there are arrow keys on the left and right sides.	Ready for calibration. Hourglass blinks.	Display (3 sec) Now the device is in HOLD mode.
 The display shows '7.00' in large digits, 'BUF' to the right, and '127mV' and '27.3°C' at the bottom. There is a 'cal' indicator at the bottom left and an hourglass icon in the top right corner. There are arrow keys on the left and right sides.	Immerse sensor in a pH 7.00 buffer. Enter the temperature-corrected pH value in the range 6.50 to 7.50 using the arrow keys (see buffer table). Confirm with <b>enter</b> .	If the zero offset of the sensor is too large ( $> \pm 200$ mV), a CAL ERR error message is generated. In that case the electrode cannot be calibrated.
 The display shows '7.00' in large digits, 'BUF' to the right, and '128mV' and '27.3°C' at the bottom. There is a 'cal' indicator at the bottom left and a blinking hourglass icon in the top right corner. There are arrow keys on the left and right sides.	Stability check. The measured value [mV] is displayed. The "hourglass" icon is blinking.	<b>Note:</b> Stability check can be stopped (by pressing <b>enter</b> ). However, this reduces calibration accuracy.

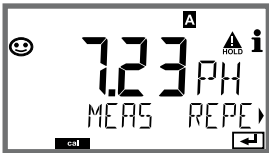
## Zero Adjustment (ISFET)





Display	Action	Remark
 <p>The display shows a smiley face icon, the number '129' with 'mV' to its right, and 'ISFET-ZERO' below. There are 'cal' and 'HOLD' indicators and arrow keys.</p>	<p>At the end of the adjustment procedure the zero offset [mV] of the sensor is displayed (based on 25 °C). Sensoface is active. Press <b>enter</b> to proceed.</p>	<p>This is not the final calibration value of the sensor! Asymmetry potential and slope must be determined with a complete 2-point calibration.</p>
 <p>The display shows a smiley face icon, the number '7.23' with 'pH' to its right, and 'MEAS REPE' below. There are 'A', 'HOLD', and 'i' indicators and arrow keys.</p>	<p>Use the arrow keys to select:</p> <ul style="list-style-type: none"> <li>• Repeat (repeat calibration) or</li> <li>• Measuring.</li> </ul> <p>Confirm by pressing <b>enter</b>.</p>	
 <p>The display shows a smiley face icon, the number '7.23' with 'pH' to its right, and 'GOOD BYE' below. There are 'A', 'HOLD', and 'i' indicators and arrow keys.</p>	<p>Place sensor in process. End zero calibration with <b>enter</b>.</p>	<p>After end of calibration, the outputs remain in HOLD mode for a short time.</p>

### Note for zero adjustment

After having adjusted the zero offset, be sure to calibrate the sensor following one of the procedures as described on the next pages.





# Automatic Calibration (Calimatic)

The AUTO calibration mode and the type of temperature detection are selected during **configuration**. Make sure that the buffer solutions used correspond to the configured buffer set. Other buffer solutions, even those with the same nominal values, may demonstrate a different temperature response. This leads to measurement errors.

Display	Action	Remark
	Select Calibration. Press <b>enter</b> to proceed.	
	Ready for calibration. Hourglass blinks. Select calibration method: CAL_PH Press <b>enter</b> to proceed.	Display (3 sec) Now the device is in HOLD mode.
	Remove the sensor and temperature probe, clean them, and immerse them in the first buffer solution (in any order). Start with <b>enter</b>	When manual input of temperature has been configured, the temp value in the display blinks and can be edited using the arrow keys.
	Buffer recognition. While the "hourglass" icon is blinking, the sensor and temperature probe remain in the first buffer solution.	The response time of the sensor and temperature probe is considerably reduced when the sensor is first moved about in the buffer solution and then held still.
	Buffer recognition terminated, the nominal buffer value is displayed.	

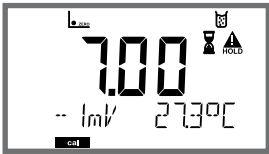
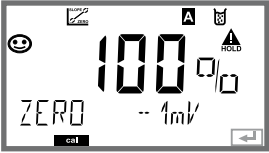

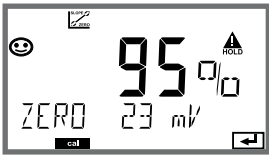
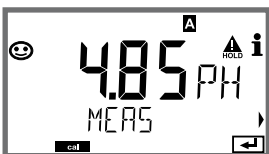



# Automatic Calibration (Calimatic)



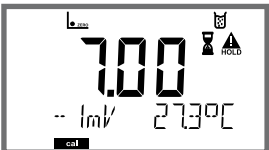

Display	Action	Remark
	<p>At the end of the stability check, the value will be saved and the asymmetry potential will be displayed.</p> <p>Calibration with the first buffer is terminated.</p>	<p><b>Note:</b> Stability check can be stopped after 10 sec (by pressing <b>enter</b>). However, this reduces calibration accuracy. Display for 1-point cal:</p> 
	<p>Remove the sensor and temp probe from the first buffer solution and rinse them thoroughly.</p> <p><b>Use the arrow keys to select:</b></p> <ul style="list-style-type: none"> <li>• END (1-point cal)</li> <li>• CAL2 (2-point cal)</li> <li>• REPEAT</li> </ul> <p>Press <b>enter</b> to proceed.</p>	
	<p>2-point calibration: Immerse sensor and temperature probe in the second buffer solution. Start with <b>enter</b></p>	<p>The calibration process runs as for the first buffer.</p>
	<p>Retract sensor and temp probe out of second buffer, rinse off, re-install.</p> <p>Press <b>enter</b> to proceed.</p>	<p>The slope and asymmetry potential of the sensor (based on 25 °C) are displayed.</p>
	<p><b>Use the arrow keys to select:</b></p> <ul style="list-style-type: none"> <li>• MEAS (exit)</li> <li>• REPEAT</li> </ul> <p>Press <b>enter</b> to proceed. Exit: HOLD is deactivated with delay.</p>	<p>When 2-point cal is ended:</p> 

# Manual Calibration with Buffer Entry

The MAN calibration mode and the type of temperature detection are selected during **configuration**. For calibration with manual buffer specification, you must enter the pH value of the buffer solution used in the device for the proper temperature. Any desired buffer solution can be used for calibration.

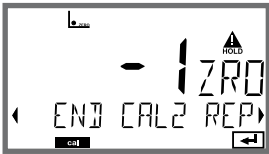
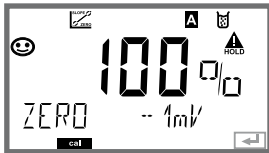
Display	Action	Remark
 The display shows 'CAL' in large digits, 'CAL_PH' below it, and a 'HOLD' icon with a triangle in the top right corner. There are left and right arrow keys at the bottom.	Select Calibration. Press <b>enter</b> to proceed.	
 The display shows 'CAL' in large digits, 'BUFFER MANUAL' below it, a smiley face icon on the left, and a 'HOLD' icon with a triangle in the top right corner. There are left and right arrow keys at the bottom.	Ready for calibration. Hourglass blinks.	Display (3 sec) Now the device is in HOLD mode.
 The display shows 'CAL M 1' in large digits, '702PH' and '274°C' below it, and a 'HOLD' icon with a triangle in the top right corner. There are left and right arrow keys at the bottom.	Remove the sensor and temperature probe, clean them, and immerse them in the first buffer solution. Press <b>enter</b> to start.	When manual input of temperature has been configured, the temp value in the display blinks and can be edited using the arrow keys.
 The display shows '07.00' in large digits, '1431' and '274°C' below it, and a 'HOLD' icon with a triangle in the top right corner. There are left and right arrow keys at the bottom.	Enter the pH value of your buffer solution for the proper temperature. While the "hourglass" icon is blinking, the sensor and temperature probe remain in the buffer solution.	The response time of the sensor and temperature probe is considerably reduced when the sensor is first moved about in the buffer solution and then held still.
 The display shows '7.00' in large digits, '-1mV' and '273°C' below it, and a 'HOLD' icon with a triangle in the top right corner. There are left and right arrow keys at the bottom.		

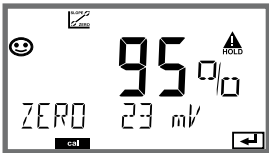
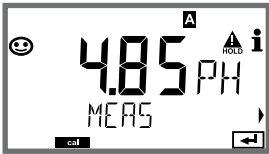





# Manual Calibration with Buffer Entry

Display	Action	Remark
	<p>At the end of the stability check, the value will be saved and the asymmetry potential will be displayed.</p> <p>Calibration with the first buffer is terminated.</p> <p>Remove the sensor and temp probe from the first buffer solution and rinse them thoroughly.</p> <p><b>Use the arrow keys to select:</b></p> <ul style="list-style-type: none"> <li>• END (1-point cal)</li> <li>• CAL2 (2-point cal)</li> <li>• REPEAT</li> </ul> <p>Press <b>enter</b> to proceed.</p>	<p><b>Note:</b></p> <p>Stability check can be stopped after 10 sec (by pressing <b>enter</b>). However, this reduces calibration accuracy. Display for 1-point cal:</p>  <p>Sensoface is active. End with <b>enter</b></p>
	<p>2-point calibration: Immerse sensor and temperature probe in the second buffer solution.</p> <p>Enter pH value.</p> <p>Press <b>enter</b> to start.</p>	<p>The calibration process runs as for the first buffer.</p>
	<p>Rinse sensor and temperature probe and reinstall them.</p> <p>Press <b>enter</b> to proceed.</p>	<p>Display of slope and new asymmetry potential (based on 25 °C).</p>
	<p><b>Use the arrow keys to select:</b></p> <ul style="list-style-type: none"> <li>• MEAS (exit)</li> <li>• REPEAT</li> </ul> <p>Press <b>enter</b> to proceed.</p> <p>Exit: HOLD is deactivated with delay.</p>	<p>When 2-point cal is ended:</p> 

# Data Entry of Premeasured Sensors

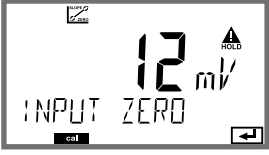
The DAT calibration mode must have been preset during configuration.

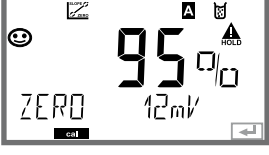
You can directly enter the values for slope and asymmetry potential of a sensor. The values must be known, e.g. determined beforehand in the laboratory.

Display	Action	Remark
	Select Calibration. Press <b>enter</b> to proceed.	
	“Data Input” Ready for calibration. Hourglass blinks.	Display (3 sec) Now the device is in HOLD mode.
	Enter asymmetry potential [mV]. Press <b>enter</b> to proceed.	
	Enter slope [%].	
	The device displays the new slope and asymmetry potential (at 25 °C). Sensoface is active.	
	<b>Use the arrow keys to select:</b> <ul style="list-style-type: none"> <li>• MEAS (exit)</li> <li>• REPEAT</li> </ul> Press <b>enter</b> to proceed.	Exit: HOLD is deactivated with delay.

# Converting Slope to mV

## Converting slope [%] to slope [mV/pH] at 25 °C

%	mV/pH
78	46.2
80	47.4
82	48.5
84	49.7
86	50.9
88	52.1
90	53.3
92	54.5
94	55.6
96	56.8
98	58.0
<b>100</b>	<b>59.2</b>
102	60.4

## Converting asymmetry potential to sensor zero point

$$\text{ZERO} = 7 - \frac{V_{AS} [\text{mV}]}{S [\text{mV} / \text{pH}]}$$

ZERO = Sensor zero

$V_{AS}$  = Asymmetry potential

S = Slope

# Product Calibration (pH)

Calibration by sampling (one-point calibration).

During product calibration the sensor remains in the process.



The measurement process is only interrupted briefly.

## Procedure:



- 1) The sample is measured in the lab or directly on the site using a portable meter. To ensure an exact calibration, the sample temperature should correspond to the measured process temperature. During sampling the device saves the currently measured value and then returns to measuring mode. The “calibration” mode indicator blinks.
- 2) In the second step you enter the measured sample value in the device. From the difference between the stored measured value and entered sample value, the device calculates the new asymmetry potential.

If the sample is invalid, you can take over the value stored during sampling. In that case the old calibration values are stored.

Afterwards, you can start a new product calibration.

Display	Action	Remark
	Select product calibration: P_CAL. Press <b>enter</b> to proceed.	
	Ready for calibration. Hourglass blinks.	Display (3 sec) Now the device is in HOLD mode.
	Take sample and save value. Press <b>enter</b> to proceed.	Now the sample can be measured.

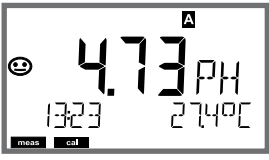
# Product Calibration (pH)

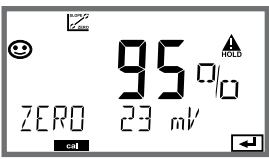
Display	Action	Remark
	The device returns to measuring mode.	From the blinking CAL mode indicator you see that product calibration has not been terminated.
	Product calibration step 2	Display (3 sec) Now the device is in HOLD mode.
	The stored value is displayed (blinking) and can be overwritten with the measured sample value. Press <b>enter</b> to proceed.	
	Display of new asymmetry potential (based on 25°C). Sensoface is active. To exit calibration: Select MEAS, then press <b>enter</b>	To repeat calibration: Select REPEAT, then press <b>enter</b>
End of calibration	After end of calibration, the outputs remain in HOLD mode for a short time.	

# ORP (Redox) Calibration

---

The potential of a redox sensor is calibrated using a redox (ORP) buffer solution. In the course of that, the difference between the measured potential and the potential of the calibration solution is determined according to the following equation. During measurement this difference is added to the measured potential.

$$mV_{\text{ORP}} = mV_{\text{meas}} - \Delta mV$$

$mV_{\text{ORP}}$  = displayed ORP

$mV_{\text{meas}}$  = direct sensor potential

$\Delta mV$  = delta value, determined during calibration





The sensor potential can also be related to another reference system – e.g. the standard hydrogen electrode. In that case the temperature-corrected potential (see table) of the reference electrode used must be entered during calibration. During measurement, this value is then added to the ORP measured.

Please make sure that measurement and calibration temperature are the same since the temperature behavior of the reference electrode is not automatically taken into account.





## Temperature dependence of commonly used reference systems measured against SHE



Temperature [°C]	Ag/AgCl/KCl 1 mol/l [ΔmV]	Ag/AgCl/KCl 3 mol/l [ΔmV]	Thalamid [ΔmV]	Mercury sulfate [ΔmV]
0	249	224	-559	672
10	244	217	-564	664
20	240	211	-569	655
25	236	207	-571	651
30	233	203	-574	647
40	227	196	-580	639
50	221	188	-585	631
60	214	180	-592	623
70	207	172	-598	613
80	200	163	-605	603



Display	Action	Remark
	Select ORP calibration, proceed with <b>enter</b>	
	Remove the sensor and temperature probe, clean them, and immerse them in the redox buffer.	Display (3 sec) Now the device is in HOLD mode.
	Enter setpoint value for redox buffer. Press <b>enter</b> to proceed.	
	The ORP delta value is displayed (based on 25°C). Sensoface is active. Press <b>enter</b> to proceed.	
	To repeat calibration: Select REPEAT. To exit calibration: Select MEAS, then press <b>enter</b>	After end of calibration, the outputs remain in HOLD mode for a short time.

# Temp Probe Adjustment

Display	Action	Remark
 The display shows 'CAL' in large characters, with 'CAL_RT0' below it. There are navigation arrows on the left and right sides. A small 'cal' indicator is at the bottom left.	Select temp adjustment. Press <b>enter</b> to proceed.	Wrong settings change the measurement properties!
 The display shows 'CAL' in large characters, with 'TEMP ADJUST' below it. A 'HOLD' icon is in the top right. A small 'cal' indicator is at the bottom left.	Measure the temperature of the process medium using an external thermometer.	Display (3 sec) Now the device is in HOLD mode.
 The display shows '25.0 °C' in large characters. Below it, 'ADJUST' and '235 °C' are visible. A 'HOLD' icon is in the top right. A small 'cal' indicator is at the bottom left.	Enter the measured temperature value. Maximum difference: 10 K. Press <b>enter</b> to proceed.	Display of actual temperature (uncompensated) in the lower display.
 The display shows '25.0 °C' in large characters. Below it, 'MEAS' is visible. A 'HOLD' icon and an 'i' icon are in the top right. A small 'cal' indicator is at the bottom left.	The corrected temperature value is displayed. Sensoface is active. To exit calibration: Select MEAS, then press <b>enter</b> . To repeat calibration: Select REPEAT, then press <b>enter</b> .	
 The display shows '7.23 PH' in large characters. Below it, 'GOOD BYE' is visible. A 'HOLD' icon and an 'A' icon are in the top right. A small 'meas' indicator is at the bottom left.	After calibration is ended, the device will switch to measuring mode.	After end of calibration, the outputs remain in HOLD mode for a short time.

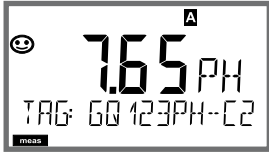
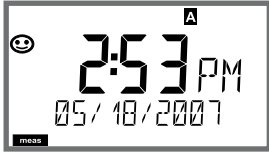
Display	Remark
	<p>From the configuration or calibration menu, you can switch the device to measuring mode by pressing the <b>meas</b> key.</p>
<p>or AM/PM and °F:</p>	<p>In the measuring mode the upper display shows the configured process variable (pH, ORP [mV], or temperature), the lower display line shows the time and the second configured process variable (pH, ORP [mV], or temperature). The [meas] mode indicator lights and the active parameter set (A/B) is indicated.</p>
	
<p>By pressing the <b>meas</b> key you can step through the following displays. When no key has been pressed for 60 sec, the device returns to the MAIN DISPLAY.</p>	
	<p>1) Selecting the parameter set (if set to "manual" in the configuration). Select the desired parameter set using the ◀ ▶ arrow keys (PARSET A or PARSET B blinks in the lower display line). Press <b>enter</b> to confirm.</p>
	<p>Further displays (each by pressing <b>meas</b>).</p>
	<p>2) Display of tag number ("TAG") 3) Display of time and date</p>

# Diagnosics

---

In the Diagnostics mode you can access the following menus without interrupting the measurement:





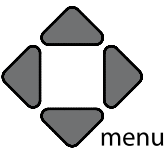

CALDATA	Viewing the calibration data
SENSOR	Viewing the sensor data
SELFTEST	Starting a device self-test
LOGBOOK	Viewing the logbook entries
MONITOR	Displaying currently measured values
VERSION	Displaying device type, software version, serial number

Access to diagnostics can be protected with a passcode (SERVICE menu).





**Note:**



HOLD is not active during Diagnostics mode!

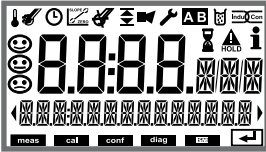



Action	Key	Remark
Activate Diagnostics		Press <b>menu</b> key to call the selection menu. (Display color changes to turquoise.) Select DIAG using ◀ ▶ keys, confirm by pressing <b>enter</b> .
Select diagnostics option		Use ◀ ▶ keys to select from: CALDATA SENSOR SELFTEST LOGBOOK MONITOR VERSION See next pages for further proceeding.
Exit	<b>meas</b>	Exit by pressing <b>meas</b> .

Display	Menu item
	<p><b>Display of calibration data</b></p> <p>Select CALDATA using ◀ ▶, confirm with <b>enter</b>.            Use the ◀ ▶ keys to select the desired parameter from the bottom line of the display (LAST_CAL ISFET-ZERO ZERO SLOPE NEXT_CAL).            The selected parameter is shown in the main display.</p>
	<p>Press <b>meas</b> to return to measurement.</p>
	
	
	
	<p><b>Display of sensor data</b></p> <p>For analog sensors, the type is displayed (STANDARD / ISFET). Not applicable for digital transmitters (-MSPH).            For digital sensors, the manufacturer, type, serial number, and last calibration date is displayed. In each case Sensoface is active.</p>
	<p>Display data using ◀ ▶ keys, return by pressing <b>enter</b> or <b>meas</b>.</p>

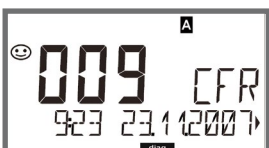
# Diagnostics

Display	Menu item
	<p><b>Device self-test</b> (To abort, you can press <b>meas.</b>)</p> <p>1) <b>Display test:</b> Display of all segments with changing background colors (white/green/red). Press <b>enter</b> to proceed.</p>
	<p>2) <b>RAM test:</b> Hourglass blinks, then display of --PASS-- or --FAIL-- Press <b>enter</b> to proceed.</p>
	<p>3) <b>EEPROM test:</b> Hourglass blinks, then display of --PASS-- or --FAIL-- Press <b>enter</b> to proceed.</p>
	<p>4) <b>FLASH test:</b> Hourglass blinks, then display of --PASS-- or --FAIL-- Press <b>enter</b> to proceed.</p>

Display	Menu item
	<p><b>Displaying the logbook entries</b>            Select LOGBOOK using ◀ ▶, press <b>enter</b> to confirm.</p> <p>Using the ▲ ▼ keys, you can scroll backwards and forwards through the logbook (entries -00-...-99-), -00- being the last entry.</p>
	<p>If the display is set to date/time, you can search for a particular date using the ▲ ▼ keys.            Press ◀ ▶ to view the corresponding message text.</p>
	<p>If the display is set to the message text, you can search for a particular message using the ▲ ▼ keys.            Press ◀ ▶ to display the date and time.</p> <p>Press <b>meas</b> to return to measurement.</p>
	<p><b>Extended logbook / Audit Trail (via TAN)</b>            Using the ▲ ▼ keys, you can scroll backwards and forwards through the extended logbook (entries -000-...-199-), -000- being the last entry.</p> <p><b>Display: CFR</b>            Audit Trail also records function activations (CAL CONFIG SERVICE), some Sensoface messages (cal timer, wear) and opening of the enclosure.</p>

Display	Menu item
	<p><b>Displaying the currently measured values (sensor monitor)</b></p>
<p>Display examples:</p>	<p>Select MONITOR using ◀ ▶, press <b>enter</b> to confirm. Use the ◀ ▶ keys to select the desired parameter from the bottom line of the display: mV_PH mV_ORP RTD R_GLASS R_REF I-INPUT (for digital sensors also: OPERATION TIME SENSOR WEAR LIFETIME CIP SIP AUTOCLAVE, for ISM sensors in addition: ACT (adaptive calibration timer) TTM (adaptive maintenance timer) DLI (Dynamic Life Time Indicator). The selected parameter is shown in the main display. Press <b>meas</b> to return to measurement.</p>
	<p>Display mV_pH (for validation, sensor can be immersed in a calibration solution, for example, or the device is checked by using a simulator)</p>
	<p>Display of remaining dynamic lifetime (only for digital sensors, however not for MEMOSENS)</p>
	<p>Display of sensor operating time (for digital sensors only)</p>
	<p><b>Version</b> Display of <b>device type, software/hardware version and serial number</b> for all device components. Use the ▲ ▼ keys to switch between software and hardware version. Press <b>enter</b> to proceed to next device component.</p>









In the Service mode you can access the following menus:

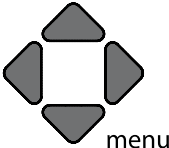

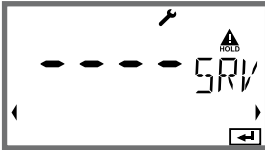
MONITOR	Displaying currently measured values
SENSOR	Resetting TTM (ISM only ), incrementing the autoclaving counter
OUT1	Testing current output 1
OUT2	Testing current output 2
CODES	Assigning and editing passcodes
DEFAULT	Resetting the device to factory settings
OPTION	Enabling options via TAN.

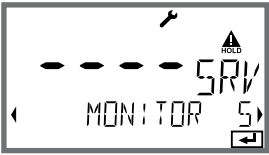
**Note:**

HOLD is active during Service mode!

















Action	Key/Display	Remark
Activate Service		Press <b>menu</b> key to call the selection menu. Select SERVICE using ◀ ▶ keys, press <b>enter</b> to confirm.
Passcode		Enter passcode "5555" for service mode using the ▲ ▼ ◀ ▶ keys. Press <b>enter</b> to confirm.
Display		In service mode the following icons are displayed: <ul style="list-style-type: none"> <li>• [diag] mode indicator</li> <li>• HOLD triangle</li> <li>• Service (wrench)</li> </ul>
Exit	<b>meas</b>	Exit by pressing <b>meas</b> .

Menu item	Remark
 <p>Display example:</p> 	<p><b>Displaying currently measured values (sensor monitor) with HOLD mode activated:</b>            Select MONITOR using ◀ ▶, press <b>enter</b> to confirm.            Select variable in the bottom text line using ◀ ▶.</p> <p>The selected parameter is shown in the upper display line.            As the device is in HOLD mode, you can perform validations using simulators without influencing the signal outputs.</p> <p>Return to Service menu:            Hold <b>meas</b> depressed for longer than 2 sec.            Press <b>meas</b> once more to return to measurement.</p>
<p>SENSOR / TTM</p> 	<p><b>Resetting the adaptive maintenance timer</b>            Here, the interval is reset to its initial value. To do so, select <b>"TTM RESET = YES"</b> and confirm by pressing <b>enter</b>.</p>
<p>SENSOR / AUTOCLAVE</p> 	<p><b>Incrementing the autoclaving counter</b>            After having completed an autoclaving process, you must increment the autoclaving count. To do so, select <b>"YES"</b> and confirm by pressing <b>enter</b>. The device confirms with <b>"INCREMENT AUTOCLAVE CYCLE"</b>.</p>
	<p><b>Specifying the current at outputs 1 and 2:</b>            Select OUT1 or OUT2 using the ◀ ▶ keys, press <b>enter</b> to confirm.            Enter a valid current value for the respective output using ▲ ▼ ◀ ▶ keys.            Press <b>enter</b> to confirm.            For checking purposes, the actual output current is shown in the bottom right corner of the display.            End by pressing <b>enter</b> or <b>meas</b>.</p>

Menu item	Remark
 <p>The LCD display shows '0000' in large digits. To the right, there is a 'PWR' icon with a triangle above it and a small 'i' icon. Below the digits, the words 'DIAG' and 'HOLD' are visible, with a right-pointing arrow next to 'HOLD'. A small 'A' icon with 'HOLD' above it is also present.</p>	<p><b>Assigning passcodes:</b> In the "SERVICE - CODES" menu you can assign passcodes to DIAG, HOLD, CAL, CONF and SERVICE modes (Service preset to 5555).</p> <p><b>When you have lost the Service passcode,</b> you have to request an "Ambulance TAN" from the manufacturer specifying the serial number of your device. To enter the "Ambulance TAN", call the Service function and enter passcode 7321. After correct input of the ambulance TAN the device signals "PASS" for 4 sec and resets the Service passcode to 5555.</p>
 <p>The LCD display shows 'FACTORY SETTING' in large letters. To the right, there is a 'PWR' icon with a triangle above it and a small 'i' icon. Below the text, the word 'NO' is visible. A small 'A' icon with 'HOLD' above it is also present.</p>	<p><b>Reset to factory settings:</b> In the "SERVICE - DEFAULT" menu you can reset the device to factory settings.</p> <p><b>NOTICE</b> After a reset to factory setting the device must be reconfigured completely, including the sensor parameters!</p>
 <p>The LCD display shows '0000' in large digits. To the right, there is a 'PWR' icon with a triangle above it and a small 'i' icon. Below the digits, the word 'TAN' is visible. At the bottom, 'OPT: LOGBOOK' is displayed. A small 'A' icon with 'HOLD' above it is also present.</p>	<p><b>Option request:</b> Communicate the serial number and hardware/software version of your device to the manufacturer. These data can be viewed in the Diagnostics/Version menu.</p> <p>The "transaction number" (TAN) you will then receive is only valid for the device with the corresponding serial number.</p> <p><b>Releasing an option:</b> Options come with a "transaction number" (TAN). To release the option, enter this TAN and confirm by pressing <b>enter</b>.</p>

# Operating States

---

Operating status	OUT 1	OUT 2	Time out
Measuring			-
DIAG			60 s
CAL			No
CONF			20 min
SERVICE			20 min
SERVICE OUT 1			20 min
SERVICE OUT 2			20 min
HOLD			No

Explanation:



as configured (Last/Fix or Last/Off)



active



manual

## **Maintenance**

Stratos Pro does not require maintenance.

If maintenance work (e.g., sensor replacement) has to be performed at the measuring point, you must activate the function check (HOLD) mode on the device as follows:

- Opening the Calibration menu
- Opening the Service menu
- Opening the Configuration menu

## **Repair**

The Stratos Pro and the measuring modules cannot be repaired by the user. To request a repair, please contact Knick Elektronische Messgeräte GmbH & Co. KG by visiting [www.knick.de](http://www.knick.de).

# A201B/X: Supply Units and Connection

Recommended Power Supply Units	Order No.
Stratos Pro A201X, Zone 1:	
Repeater power supply, Ex, 90...253 V AC, output 4...20 mA	WG 21 A7
Repeater power supply, Ex, 90...253 V AC, HART, output 4...20 mA	WG 21 A7 Opt. 470
Repeater power supply, Ex, 24 V AC/DC, output 4...20 mA	WG 21 A7 Opt. 336
Repeater power supply, Ex, 24 V AC/DC, HART, output 4...20 mA	WG 21 A7 Opt. 336, 470
Stratos Pro A201B, Zone 2:	
Repeater power supply, non-Ex, 24 V DC, output 4...20 mA	IsoAmp PWR B 10116
Repeater power supply, non-Ex, 24 V DC, HART, output 0/4...20 mA / 0...10 V	IsoAmp PWR A 20100

## Connection to Supply Units

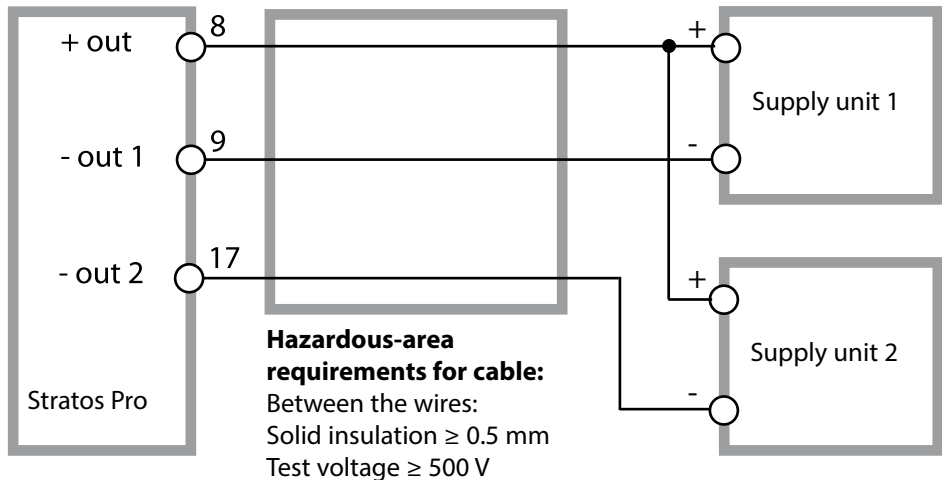

# Product Line and Accessories

## Order Code Stratos Pro A 201

										TAN
<b>Example</b>	A	2	0	1	X	-	MSPH	-	1	
2-wire / 4-20 mA	A	2								B,C,E
<b>Communication</b>										
Without (HART retrofittable via TAN)			0							A
<b>Version number</b>										
Version				1						
<b>Approvals</b>										
General Safety										N
ATEX / IECEx Zone 2										B
ATEX / IECEx / FM Zone 1 / CI 1 Div 1										X
<b>Measuring channel</b>										
Memosens pH / Redox	digital						MSPH			G
Memosens Cond	digital						MSCOND			
Memosens Condi	digital						MSCONDI			
Memosens Oxy	digital						MSOXY			
Dual COND (2x2-electrode sensors, analog)					N		CC			
pH / ORP value (ISM digital per TAN)	Measuring module						PH			F, G
Cond, 2-/4-electrode	Measuring module						COND			
Conductivity, electrodeless	Measuring module						CONDI			
Oxygen (ISM digital and traces per TAN)	Measuring module						OXY			D, F
<b>Options</b>										
Without 2nd current output									0	
With 2nd current output									1	
<b>TAN options</b>										
HART							SW-A001			(A)
Logbook							SW-A002			(B)
Extended logbook (Audit Trail)							SW-A003			(C)
Trace oxygen measurement							SW-A004			(D)
Current input + 2 digital inputs							SW-A005			(E)
ISM digital							SW-A006			(F)
Pfandler							SW-A007			(G)
<b>Mounting accessories</b>										
Pipe-mount kit							ZU 0274			
Protective hood							ZU 0737			
Panel-mount kit							ZU 0738			

# Specifications

<b>pH input</b>	Input for digital sensors (RS-485)	
Display range	pH value	-2.00 ... 16.00
	ORP	-1999 ... 1999 mV
	Temperature	-20.0 ... 200.0 °C / -4 ... 392 °F
	rH value (with pH/ORP sensor)	0 ... 42.5
<b>pH sensor standardization</b> *	pH calibration	
Operating modes	BUF	Calibration with Calimatic automatic buffer recognition
	MAN	Manual calibration with entry of individual buffer values
	DAT	Data entry of pre-measured electrodes
Calimatic buffer sets*	Product calibration	
	-01- Mettler-Toledo	2.00/4.01/7.00/9.21
	-02- Knick CaliMat	2.00/4.00/7.00/9.00/12.00
	-03- Ciba (94)	2.06/4.00/7.00/10.00
	-04- NIST technical	1.68/4.00/7.00/10.01/12.46
	-05- NIST standard	1.679/4.006/6.865/9.180
	-06- HACH	4.01/7.00/10.01
	-07- WTW techn. buffers	2.00/4.01/7.00/10.00
	-08- Hamilton	4.01/7.00/10.01/12.00
	-09- Reagecon	2.00/4.00/7.00/9.00/12.00
	-10- DIN 19267	1.09/4.65/6.79/9.23/12.75
	-11- Hamilton A	2.00/4.01/7.00/9.00/11.00
	-12- Hamilton B	2.00/4.01/6.00/9.00/11.00
	-13- Kraft	2.00/4.00/7.00/9.00/11.00
-U1-	Specifiable buffer set with 2 buffer solutions	
Zero adjustment	± 200 mV (for ISFET)	
Max. calibration range	Asymmetry potential	±60 mV
	Slope	80 ... 103 % (47.5 ... 61 mV/pH) (possibly restricting notes from Sensoface)
<b>ORP sensor standardization</b> *	ORP calibration (zero adjustment)	
Max. calibration range	-700 ... +700 ΔmV	
<b>Adaptive cal timer</b> *	Interval 0000 ... 9999 h (Patent DE 101 41 408)	
<b>Sensocheck</b>	Automatic monitoring of glass electrode (can be disabled)	
Delay	Approx. 30 s	
<b>Sensoface</b>	Provides information on the sensor condition, evaluation of zero/slope, response time, calibration interval, wear, Sensocheck, can be switched off	



<b>I input (TAN)</b>	Current input 0/4 ... 20 mA / 50 Ω for external temperature signal		
Start/end of scale	Configurable -20 ... 200 °C / -4 ... 392 °F		
Characteristic	Linear		
Resolution	approx. 0.05 mA		
Measurement error <sup>1,3)</sup>	< 1 % of current value + 0.1 mA		
<b>HOLD input (TAN)</b>	Galvanically isolated (optocoupler)		
Function	Switches device to HOLD mode		
Switching voltage	0 ... 2 V AC/DC	HOLD inactive	
	10 ... 30 V AC/DC	HOLD active	
<b>CONTROL input (TAN)</b>	Galvanically isolated (optocoupler)		
Function	Switch between parameter sets A/B or flow measurement (FLOW)		
Parameter set A/B	Control input	0 ... 2 V AC/DC	Parameter set A
		10 ... 30 V AC/DC	Parameter set B
FLOW	Pulse input for flow measurement 0 ... 100 pulses/s Pulse amplitude 10 ... 30 V DC		
Message	via 22 mA		
Display	00.0 ... 99.9 l/h		
<b>Output 1</b>	4 ... 20 mA current loop, floating, reverse polarity protected HART communication (see below for specifications)		
Supply voltage	14 ... 30 V		
Process variable <sup>2)</sup>	pH, ORP, rH (with pH/ORP combo sensor only), or temperature		
Characteristic	Linear		
Resolution	approx. 0.05 mA		
Overrange <sup>2)</sup>	22 mA in the case of error messages		
Output filter *	PT <sub>1</sub> filter, filter time constant 0 ... 120 s		
Measurement error <sup>1)</sup>	< 0.25% of current value + 0.025 mA		
Start/end of scale *	Configurable within selected range		

# Specifications

---

## Output 2

For version with 2nd current output only

4 ... 20 mA current loop, floating, reverse polarity protected

Supply voltage

14 ... 30 V

Process variable <sup>7)</sup>

pH, ORP, rH (with pH/ORP combo sensor only), or temperature

Characteristic

Linear

Resolution

approx. 0.05 mA

Overrange <sup>7)</sup>

22 mA in the case of error messages

Output filter \*

PT, filter, filter time constant 0 ... 120 s

Measurement error <sup>1)</sup>

< 0.25% of current value + 0.05 mA

Start/end of scale \*

Configurable within selected range

---

## Real-time clock

Different time and date formats selectable

Power reserve

> 5 days

---

## Display

LC display, 7-segment with icons

Main display

Character height approx. 22 mm, unit symbols approx. 14 mm

Secondary display

Character height approx. 10 mm

Text line

14 characters, 14 segments

Sensoface

3 status indicators (friendly, neutral, sad face)

Status indicators

meas, cal, conf, diag

Further icons for configuration and messages

Alarm indication

Display blinks and red backlighting

---

## Keypad

Keys: meas, menu, info, 4 cursor keys, enter

---

## HART communication (TAN)

HART version 6

Digital communication via FSK modulation of output current 1

Device identification, measured values, status and messages, parameter setting, calibration, logs

---

## FDA 21 CFR Part 11

Access control via editable passcodes, logbook entry and flag via HART in the case of configuration changes

Message and logbook entry when housing is opened

---

<b>Diagnostic functions</b>	
Calibration data	Calibration date, zero, slope, response time
Device self-test	Display test, Automatic memory test (RAM, FLASH, EEPROM), module test
Logbook (TAN)	100 events with date and time
Extended logbook (TAN)	Audit Trail: 200 events with date and time
<b>Service functions</b>	
Sensor monitor	Display of direct sensor signals
Current source	Current specifiable for output 1 and 2 (04.00 ... 22.00 mA)
Passcodes	Assignment of passcodes for access to menus
Factory setting	Reset all parameters to factory settings
TAN	Enable optionally available add-on functions
<b>Data retention</b>	
Parameters, calibration data, and logbook > 10 years (EEPROM)	
<b>Housing</b>	
Molded enclosure, glass fiber reinforced Front unit material: PBT Rear unit material: PC	
Mounting	Wall, pipe/post or panel mounting
Color	Gray RAL 7001
Ingress protection	IP66/IP67/TYP E 4X outdoor (with pressure compensation) when the device is closed
Flammability	UL 94 V-0 for external parts
Dimensions	148 mm x 148 mm
Control panel cutout	138 mm x 138 mm acc. to DIN 43 700
Weight	approx. 1200 kg (1.6 kg incl. accessories and packaging)
Cable glands	5 knockouts for M20 x 1.5 cable glands 2 of 5 knockouts for NPT ½" or rigid metallic conduit
<b>Terminals</b>	
Screw terminals	for single or stranded wires 0.2... 2.5 mm <sup>2</sup>
Tightening torque	0.5 ... 0.6 Nm

# Specifications

---

## Wiring

Stripping length	Max. 7 mm
Temperature resistance	> 75 °C / 167 °F

## Rated operating conditions

Climatic class	3K5 according to EN 60721-3-3
Location class	C1 according to EN 60654-1
Ambient temperature	-20 ... 65 °C / -4 ... 149 °F
Relative humidity	5 ... 95 %
Supply voltage	14 ... 30 V

## Transport and storage

Transport / storage temperature	-30 ... 70 °C / -22 ... 158 °F
---------------------------------	--------------------------------

## EMC

Emitted interference	Class A (industrial applications) <sup>4)</sup>
Immunity to interference	Industrial applications

\*) User-defined

1) At rated operating conditions

2) ± 1 digit

3) Plus sensor error

4) This equipment is not designed for domestic use, and is unable to guarantee adequate protection of the radio reception in such environments.

-01- Mettler-Toledo  
 (corresponds to former "Knick technical buffers")  
 Nominal values in bold.

°C	pH			
0	2.03	4.01	7.12	9.52
5	2.02	4.01	7.09	9.45
10	2.01	4.00	7.06	9.38
15	2.00	4.00	7.04	9.32
20	2.00	4.00	7.02	9.26
<b>25</b>	<b>2.00</b>	<b>4.01</b>	<b>7.00</b>	<b>9.21</b>
30	1.99	4.01	6.99	9.16
35	1.99	4.02	6.98	9.11
40	1.98	4.03	6.97	9.06
45	1.98	4.04	6.97	9.03
50	1.98	4.06	6.97	8.99
55	1.98	4.08	6.98	8.96
60	1.98	4.10	6.98	8.93
65	1.99	4.13	6.99	8.90
70	1.99	4.16	7.00	8.88
75	2.00	4.19	7.02	8.85
80	2.00	4.22	7.04	8.83
85	2.00	4.26	7.06	8.81
90	2.00	4.30	7.09	8.79
95	2.00	4.35	7.12	8.77

## Buffer Tables

---

-02- Knick CaliMat  
(Merck Titrisols, Riedel-de-Haen Fixanals)  
Nominal values in bold.

°C	pH				
0	2.01	4.05	7.09	9.24	12.58
5	2.01	4.04	7.07	9.16	12.39
10	2.01	4.02	7.04	9.11	12.26
15	2.00	4.01	7.02	9.05	12.13
<b>20</b>	<b>2.00</b>	<b>4.00</b>	<b>7.00</b>	<b>9.00</b>	<b>12.00</b>
25	2.00	4.01	6.99	8.95	11.87
30	2.00	4.01	6.98	8.91	11.75
35	2.00	4.01	6.96	8.88	11.64
40	2.00	4.01	6.96	8.85	11.53
50	2.00	4.01	6.96	8.79	11.31
60	2.00	4.00	6.96	8.73	11.09
70	2.00	4.00	6.96	8.70	10.88
80	2.00	4.00	6.98	8.66	10.68
90	2.00	4.00	7.00	8.64	10.48

**-03-** Ciba (94) buffers  
 Nominal values: 2.06 4.00 7.00 10.00

°C	pH			
0	2.04	4.00	7.10	10.30
5	2.09	4.02	7.08	10.21
10	2.07	4.00	7.05	10.14
15	2.08	4.00	7.02	10.06
20	2.09	4.01	6.98	9.99
25	2.08	4.02	6.98	9.95
30	2.06	4.00	6.96	9.89
35	2.06	4.01	6.95	9.85
40	2.07	4.02	6.94	9.81
45	2.06	4.03	6.93	9.77
50	2.06	4.04	6.93	9.73
55	2.05	4.05	6.91	9.68
60	2.08	4.10	6.93	9.66
65	2.07*	4.10*	6.92*	9.61*
70	2.07	4.11	6.92	9.57
75	2.04*	4.13*	6.92*	9.54*
80	2.02	4.15	6.93	9.52
85	2.03*	4.17*	6.95*	9.47*
90	2.04	4.20	6.97	9.43
95	2.05*	4.22*	6.99*	9.38*

\* extrapolated

# Buffer Tables

**-04-** NIST technical buffers  
Nominal values in bold.

°C	pH				
0	1.67	4.00	7.115	10.32	13.42
5	1.67	4.00	7.085	10.25	13.21
10	1.67	4.00	7.06	10.18	13.01
15	1.67	4.00	7.04	10.12	12.80
20	1.675	4.00	7.015	10.06	12.64
<b>25</b>	<b>1.68</b>	<b>4.005</b>	<b>7.00</b>	<b>10.01</b>	<b>12.46</b>
30	1.68	4.015	6.985	9.97	12.30
35	1.69	4.025	6.98	9.93	12.13
40	1.69	4.03	6.975	9.89	11.99
45	1.70	4.045	6.975	9.86	11.84
50	1.705	4.06	6.97	9.83	11.71
55	1.715	4.075	6.97	9.83*	11.57
60	1.72	4.085	6.97	9.83*	11.45
65	1.73	4.10	6.98	9.83*	11.45*
70	1.74	4.13	6.99	9.83*	11.45*
75	1.75	4.14	7.01	9.83*	11.45*
80	1.765	4.16	7.03	9.83*	11.45*
85	1.78	4.18	7.05	9.83*	11.45*
90	1.79	4.21	7.08	9.83*	11.45*
95	1.805	4.23	7.11	9.83*	11.45*

\* Values complemented



-05- NIST Standard (DIN 19266 : 2015-05)  
Nominal values in bold.

°C	pH				
0	1.666	4.000	6.984	9.464	
5	1.668	3.998	6.951	9.395	13.207
10	1.670	3.997	6.923	9.332	13.003
15	1.672	3.998	6.900	9.276	12.810
20	1.675	4.000	6.881	9.225	12.627
<b>25</b>	<b>1.679</b>	<b>4.005</b>	<b>6.865</b>	<b>9.180</b>	<b>12.454</b>
30	1.683	4.011	6.853	9.139	12.289
35	1.688	4.018	6.844	9.102	12.133
37		4.022	6.841	9.088	
38	1.691				12.043
40	1.694	4.027	6.838	9.068	11.984
45					11.841
50	1.707	4.050	6.833	9.011	11.705
55	1.715	4.075	6.834	8.985	11.574
60	1.723	4.091	6.836	8.962	11.449
70	1.743	4.126	6.845	8.921	
80	1.766	4.164	6.859	8.885	
90	1.792	4.205	6.877	8.850	
95	1.806	4.227	6.886	8.833	

**Note:** The actual pH values of the individual batches of the reference materials are documented in a certificate of an accredited laboratory. This certificate is supplied with the respective buffers. Only these pH(S) values shall be used as standard values for the secondary reference buffer materials. Correspondingly, this standard does not include a table with standard pH values for practical use. The table above only provides examples of pH(PS) values for orientation.

## Buffer Tables

---

-06- HACH buffers  
Nominal values in bold.

°C	pH		
0	4.00	7.118	10.30
5	4.00	7.087	10.23
10	4.00	7.059	10.17
15	4.00	7.036	10.11
20	4.00	7.016	10.05
<b>25</b>	<b>4.01</b>	<b>7.00</b>	<b>10.00</b>
30	4.01	6.987	9.96
35	4.02	6.977	9.92
40	4.03	6.97	9.88
45	4.05	6.965	9.85
50	4.06	6.964	9.82
55	4.07	6.965	9.79
60	4.09	6.968	9.76
65	4.10	6.98	9.71
70	4.12	7.00	9.66
75	4.14	7.02	9.63
80	4.16	7.04	9.59
85	4.18	7.06	9.56
90	4.21	7.09	9.52
95	4.24	7.12	9.48

-07- WTW technical buffers  
Nominal values in bold.

°C	pH			
0	2.03	4.01	7.12	10.65
5	2.02	4.01	7.09	10.52
10	2.01	4.00	7.06	10.39
15	2.00	4.00	7.04	10.26
20	2.00	4.00	7.02	10.13
<b>25</b>	<b>2.00</b>	<b>4.01</b>	<b>7.00</b>	<b>10.00</b>
30	1.99	4.01	6.99	9.87
35	1.99	4.02	6.98	9.74
40	1.98	4.03	6.97	9.61
45	1.98	4.04	6.97	9.48
50	1.98	4.06	6.97	9.35
55	1.98	4.08	6.98	
60	1.98	4.10	6.98	
65	1.99	4.13	6.99	
70	2.00	4.16	7.00	
75	2.00	4.19	7.02	
80	2.00	4.22	7.04	
85	2.00	4.26	7.06	
90	2.00	4.30	7.09	
95	2.00	4.35	7.12	

# Buffer Tables

**-08-** Hamilton Duracal buffers  
Nominal values in bold.

°C	pH				
0	1.99	4.01	7.12	10.23	12.58
5	1.99	4.01	7.09	10.19	12.46
10	2.00	4.00	7.06	10.15	12.34
15	2.00	4.00	7.04	10.11	12.23
20	2.00	4.00	7.02	10.06	12.11
<b>25</b>	<b>2.00</b>	<b>4.01</b>	<b>7.00</b>	<b>10.01</b>	<b>12.00</b>
30	1.99	4.01	6.99	9.97	11.90
35	1.98	4.02	6.98	9.92	11.80
40	1.98	4.03	6.97	9.86	11.70
45	1.97	4.04	6.97	9.83	11.60
50	1.97	4.05	6.97	9.79	11.51
55	1.98	4.06	6.98	9.75	11.42
60	1.98	4.08	6.98	9.72	11.33
65	1.98	4.10*	6.99*	9.69*	11.24
70	1.99	4.12*	7.00*	9.66*	11.15
75	1.99	4.14*	7.02*	9.63*	11.06
80	2.00	4.16*	7.04*	9.59*	10.98
85	2.00	4.18*	7.06*	9.56*	10.90
90	2.00	4.21*	7.09*	9.52*	10.82
95	2.00	4.24*	7.12*	9.48*	10.74

\* Values complemented

-09- Reagecon buffers  
Nominal values in bold.

°C	pH				
0	2.01*	4.01*	7.07*	9.18*	12.54*
5	2.01*	4.01*	7.07*	9.18*	12.54*
10	2.01	4.00	7.07	9.18	12.54
15	2.01	4.00	7.04	9.12	12.36
20	2.01	4.00	7.02	9.06	12.17
<b>25</b>	<b>2.00</b>	<b>4.00</b>	<b>7.00</b>	<b>9.00</b>	<b>12.00</b>
30	1.99	4.01	6.99	8.95	11.81
35	2.00	4.02	6.98	8.90	11.63
40	2.01	4.03	6.97	8.86	11.47
45	2.01	4.04	6.97	8.83	11.39
50	2.00	4.05	6.96	8.79	11.30
55	2.00	4.07	6.96	8.77	11.13
60	2.00	4.08	6.96	8.74	10.95
65	2.00*	4.10*	6.99*	8.70*	10.95*
70	2.00*	4.12*	7.00*	8.67*	10.95*
75	2.00*	4.14*	7.02*	8.64*	10.95*
80	2.00*	4.16*	7.04*	8.62*	10.95*
85	2.00*	4.18*	7.06*	8.60*	10.95*
90	2.00*	4.21*	7.09*	8.58*	10.95*
95	2.00*	4.24*	7.12*	8.56*	10.95*

\* Values complemented

# Buffer Tables

-10- DIN 19267 buffers  
Nominal values in bold.

pH	°C				
0	1.08	4.67	6.89	9.48	13.95*
5	1.08	4.67	6.87	9.43	13.63*
10	1.09	4.66	6.84	9.37	13.37
15	1.09	4.66	6.82	9.32	13.16
20	1.09	4.65	6.80	9.27	12.96
<b>25</b>	<b>1.09</b>	<b>4.65</b>	<b>6.79</b>	<b>9.23</b>	<b>12.75</b>
30	1.10	4.65	6.78	9.18	12.61
35	1.10	4.65	6.77	9.13	12.45
40	1.10	4.66	6.76	9.09	12.29
45	1.10	4.67	6.76	9.04	12.09
50	1.11	4.68	6.76	9.00	11.89
55	1.11	4.69	6.76	8.96	11.79
60	1.11	4.70	6.76	8.92	11.69
65	1.11	4.71	6.76	8.90	11.56
70	1.11	4.72	6.76	8.88	11.43
75	1.11	4.73	6.77	8.86	11.31
80	1.12	4.75	6.78	8.85	11.19
85	1.12	4.77	6.79	8.83	11.09
90	1.13	4.79	6.80	8.82	10.99
95	1.13*	4.82*	6.81*	8.81*	10.89*

\* extrapolated

-11- Hamilton A  
Nominal values in bold.

pH	°C				
0	1.99	4.01	7.12	9.31	11.42
5	1.99	4.01	7.09	9.24	11.33
10	2.00	4.00	7.06	9.17	11.25
15	2.00	4.00	7.04	9.11	11.16
20	2.00	4.00	7.02	9.05	11.07
<b>25</b>	<b>2.00</b>	<b>4.01</b>	<b>7.00</b>	<b>9.00</b>	<b>11.00</b>
30	1.99	4.01	6.99	8.95	10.93
35	1.98	4.02	6.98	8.90	10.86
40	1.98	4.03	6.97	8.85	10.80
45	1.97	4.04	6.97	8.82	10.73
50	1.97	4.05	6.97	8.78	10.67
55	1.98	4.06	6.98	8.75	10.61
60	1.98	4.08	6.98	8.72	10.55
65	1.98	4.10	6.99	8.70	10.49
70	1.99	4.12	7.00	8.67	10.43
75	1.99	4.14	7.02	8.64	10.38
80	2.00	4.16	7.04	8.62	10.33
85	2.00	4.18	7.06	8.60	10.28
90	2.00	4.21	7.09	8.58	10.23
95	2.00	4.24	7.12	8.56	10.18

# Buffer Tables

---

-12- Hamilton B  
Nominal values in bold.

---

pH	°C				
0	1.99	4.01	6.03	9.31	11.42
5	1.99	4.01	6.02	9.24	11.33
10	2.00	4.00	6.01	9.17	11.25
15	2.00	4.00	6.00	9.11	11.16
20	2.00	4.00	6.00	9.05	11.07
<b>25</b>	<b>2.00</b>	<b>4.01</b>	<b>6.00</b>	<b>9.00</b>	<b>11.00</b>
30	1.99	4.01	6.00	8.95	10.93
35	1.98	4.02	6.00	8.90	10.86
40	1.98	4.03	6.01	8.85	10.80
45	1.97	4.04	6.02	8.82	10.73
50	1.97	4.05	6.04	8.78	10.67
55	1.98	4.06	6.06	8.75	10.61
60	1.98	4.08	6.09	8.72	10.55
65	1.98	4.10	6.11	8.70	10.49
70	1.99	4.12	6.13	8.67	10.43
75	1.99	4.14	6.15	8.64	10.38
80	2.00	4.16	6.18	8.62	10.33
85	2.00	4.18	6.21	8.60	10.28
90	2.00	4.21	6.24	8.58	10.23
95	2.00	4.24	6.27	8.56	10.18

---



-13- Kraft  
Nominal values in bold.

pH	°C				
0	2.01	4.05	7.13	9.24	11.47*
5	2.01	4.04	7.07	9.16	11.47
10	2.01	4.02	7.05	9.11	11.31
15	2.00	4.01	7.02	9.05	11.15
<b>20</b>	<b>2.00</b>	<b>4.00</b>	<b>7.00</b>	<b>9.00</b>	<b>11.00</b>
25	2.00	4.01	6.98	8.95	10.85
30	2.00	4.01	6.98	8.91	10.71
35	2.00	4.01	6.96	8.88	10.57
40	2.00	4.01	6.95	8.85	10.44
45	2.00	4.01	6.95	8.82	10.31
50	2.00	4.00	6.95	8.79	10.18
55	2.00	4.00	6.95	8.76	10.18*
60	2.00	4.00	6.96	8.73	10.18*
65	2.00	4.00	6.96	8.72	10.18*
70	2.01	4.00	6.96	8.70	10.18*
75	2.01	4.00	6.96	8.68	10.18*
80	2.01	4.00	6.97	8.66	10.18*
85	2.01	4.00	6.98	8.65	10.18*
90	2.01	4.00	7.00	8.64	10.18*
95	2.01	4.00	7.02	8.64	10.18*

\* Values complemented

## **-U1- Specifiable Buffer Set**

---

You can specify a buffer set with 2 buffer solutions in the temperature range of 0 ... 95 °C, step width: 5 °C.

To do so, select buffer set -U1- in the configuration menu.

As delivered, the Ingold technical buffer solutions pH 4.01 / 7.00 are stored as buffer set and can be edited.



### **Conditions for the specifiable buffer set:**

- All values must lie in the range pH 0 ... 14
- Maximum difference between two adjacent pH values (5 °C step width) of the same buffer solution: pH 0.25
- The values of buffer solution 1 must be lower than those of buffer solution 2:  
The difference between values for identical temperatures must be greater than 2 pH units.

Faulty entries are indicated in measuring mode by the "FAIL BUFFERSET -U1-" message.

The 25 °C value is always used for buffer display during calibration.

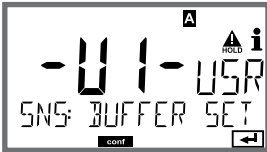
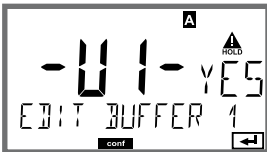
# -U1- Specifiable Buffer Set

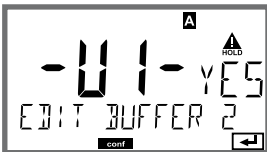
Step	Action/Display	Remark
Select buffer set -U1- (CONFIG / SNS menu)		
Select buffer solution 1 for editing	 <p data-bbox="428 564 695 627">Select "YES" using up/down key.</p>	You are prompted for confirmation to prevent accidental changes of the settings.
Editing the values of buffer solution 1	 <p data-bbox="428 826 736 959">Edit using arrow keys, press <b>enter</b> to confirm and proceed to next temperature value.</p> 	Enter the values for the first buffer solution in 5°C steps. The difference to the next value must not exceed 0.25 pH unit.
Select buffer solution 2 for editing		The difference between buffer solutions for identical temperatures must be greater than 2 pH units.

## -U1- Specifiable Buffer Set

---

### Buffer Set U1:

Fill in your configuration data or use the table as original for copy.

Temperature (°C)	Buffer 1	Buffer 2
5		
10		
15		
20		
25		
30		
35		
40		
45		
50		
55		
60		
65		
70		
75		
80		
85		
90		
95		

## Alarm condition:

- The display backlighting turns **red**
- The alarm icon  is displayed
- The complete measured-value display blinks
- “**ERR xxx**” is displayed in the lower menu line

Press the [**info**] key to view a short error text:

- The error text appears in the lower menu line
- The main display reads “**InFo**”.

## Parameter errors:

Configuration data such as current range, limit values, etc are checked during the input.

If they are out of range,

- “**ERR xxx**” is displayed for 3 sec,
- the display backlighting flashes red,
- the respective maximum or minimum value is shown,
- input must be repeated.

If a faulty parameter arrives through the interface (HART),

- an error message will be displayed: “**ERR 100...199**”
- the faulty parameter can be localized by pressing the [**info**] key

## Calibration errors:

If errors occur during calibration,

- an error message will be displayed

## Sensoface:

If the Sensoface becomes sad,

- the display backlighting will turn magenta (purple)
- the cause can be seen by pressing the **info** key
- the calibration data can be seen in the Diagnostics menu

# Error Messages

<b>Error</b>	<b>Info text</b> (is displayed in case of fault when the Info key is pressed)	<b>Problem</b> <b>Possible causes</b>
<b>ERR 99</b>	DEVICE FAILURE	<b>Error in factory settings</b> EEPROM or RAM defective This error message only occurs in the case of a total defect. The device must be repaired and recalibrated at the factory.
<b>ERR 98</b>	CONFIGURATION ERROR	<b>Error in configuration or calibration data</b> Memory error in device program Configuration or calibration data defective; completely reconfigure and recalibrate the device.
<b>ERR 97</b>	NO MODULE INSTALLED	"MEMOSENS" not selected as sensor type
<b>ERR 96</b>	WRONG MODULE	"MEMOSENS" not selected as sensor type
<b>ERR 95</b>	SYSTEM ERROR	<b>System error</b> Restart required. If error still persists, send in the device for repair.
<b>ERR 01</b>	NO SENSOR	<b>pH sensor *</b> The sensor is not recognized: Check connections. Check cables/sensor. Replace as required.
<b>ERR 02</b>	WRONG SENSOR	<b>Wrong sensor *</b> Replace the sensor.
<b>ERR 04</b>	SENSOR FAILURE	<b>Failure in sensor *</b> Replace the sensor.

<b>Error</b>	<b>Info text</b> (is displayed in case of fault when the Info key is pressed)	<b>Problem</b> <b>Possible causes</b>
<b>ERR 05</b>	CAL DATA	<b>Error in cal data *</b>
<b>ERR 10</b>	ORP RANGE	<b>ORP display range limits exceeded</b> < -1999 mV or > 1999 mV
<b>ERR 11</b>	PH RANGE	<b>pH display range limits exceeded</b> < -2 or > 16
<b>ERR 12</b>	MV RANGE	<b>mV range</b>
<b>ERR 13</b>	TEMPERATURE RANGE	<b>Temperature range limits exceeded</b> Connect the sensor, check the sensor cable and replace if necessary, check the sensor connection, adjust the parameter settings.
<b>ERR 15</b>	SENSOCHECK GLASS-EL	<b>Sensocheck glass</b>
<b>ERR 16</b>	SENSOCHECK REF-EL	<b>Sensocheck ref.</b>
<b>ERR 60</b>	OUTPUT LOAD	<b>Load error</b> Check the current loop, deactivate unused current outputs.
<b>ERR 61</b>	OUTPUT 1 TOO LOW	<b>Output current 1</b> < 3.8 mA
<b>ERR 62</b>	OUTPUT 1 TOO HIGH	<b>Output current 1</b> > 20.5 mA
<b>ERR 63</b>	OUTPUT 2 TOO LOW	<b>Output current 2</b> < 3.8 mA
<b>ERR 64</b>	OUTPUT 2 TOO HIGH	<b>Output current 2</b> > 20.5 mA

\*) Digital sensors (ISM, InduCon, Memosens)

# Error Messages

---

<b>Error</b>	<b>Info text</b> (is displayed in case of fault when the Info key is pressed)	<b>Problem</b> <b>Possible causes</b>
<b>ERR 69</b>	TEMP. OUTSIDE TABLE	<b>Temperature</b> value outside table
<b>ERR 72</b>	FLOW TOO LOW	<b>Flow</b> too low
<b>ERR 73</b>	FLOW TOO HIGH	<b>Flow</b> too high
<b>ERR 100</b>	INVALID SPAN OUT1	<b>Span Out1 configuration error</b> Selected span too small
<b>ERR 101</b>	INVALID SPAN OUT2	<b>Span Out2 configuration error</b> Selected span too small
<b>ERR 102</b>	FAILURE BUFFERSET -U1-	<b>Configuration error</b> Specifiable buffer set U1
<b>ERR 105</b>	INVALID SPAN I-INPUT	<b>Configuration error</b> Current input



## **Disposal**

Local codes and regulations must be observed when disposing of the product.

## **Returns**

If required, send the product in a clean condition and securely packed to your local contact. See [www.knick.de](http://www.knick.de).

# Sensoface

---

(Sensocheck must have been activated during configuration.)

The smiley in the display (Sensoface) alerts to sensor problems (defective sensor, sensor wear, defective cable, maintenance request). The permitted calibration ranges and the conditions for a friendly, neutral, or sad Sensoface are summarized in the following table. Additional icons refer to the error cause.

## Sensocheck

Continuously monitors the sensor and its wiring.

Critical values make the Sensoface “sad” and the corresponding icon blinks:



The Sensocheck message is also output as error message Err 15 (glass electrode) or Err 16 (reference electrode – for digital transmitters, however only with InduCon sensors with SG). The display backlighting turns red, output current 1 is set to 22 mA (when configured correspondingly).











Sensocheck can be switched off during configuration (then Sensoface is also disabled).

### Exception:



After a calibration a smiley is always displayed for confirmation.

### Note:

The worsening of a Sensoface criterion leads to the devaluation of the Sensoface indicator (Smiley becomes “sad”). An improvement of the Sensoface indicator can only take place after calibration or removal of the sensor defect.

Display	Problem	Status
	Asymmetry potential and slope	 <p>Asymmetry potential (zero) and slope of the sensor are still okay. The sensor should be replaced soon.</p>
		 <p>Asymmetry potential and slope of the sensor have reached values which no longer ensure proper calibration. Replace sensor.</p>
	Calibration timer	 <p>Over 80% of the calibration interval has already past.</p>
		 <p>The calibration interval has been exceeded.</p>
	Sensor defect	 <p>Check the sensor and its connections (see also Error Messages Err 15 and Err 16).</p>
	Response time	 <p>Sensor response time has increased. The sensor should be replaced soon. To achieve an improvement, clean the sensor and soak it in buffer.</p>
		 <p>Sensor response time significantly increased ( &gt; 72 s, calibration aborted after 120 s) Replace sensor.</p>

# Sensoface

Display	Problem	Status
	Sensor wear (for digital sensors only)	 High temperatures and pH values have caused a wear of over 80%. The sensor should be replaced soon.   Wear is at 100%. Replace sensor.
SENSOR WEAR CHANGE SENSOR (DLI)		Replace sensor
AUTOCLAVE CYCLES OVERRUN		Maximally permitted number of autoclaving cycles has been reached. Replace sensor or increment autoclaving counter.
SIP CYCLES OVERRUN		Maximally permitted number of sterilizing cycles has been reached. Replace sensor or increment SIP counter.
CIP CYCLES OVERRUN		Maximally permitted number of cleaning cycles has been reached. Replace sensor or increment CIP counter.

# HART: Typical Applications

(SW-A001)

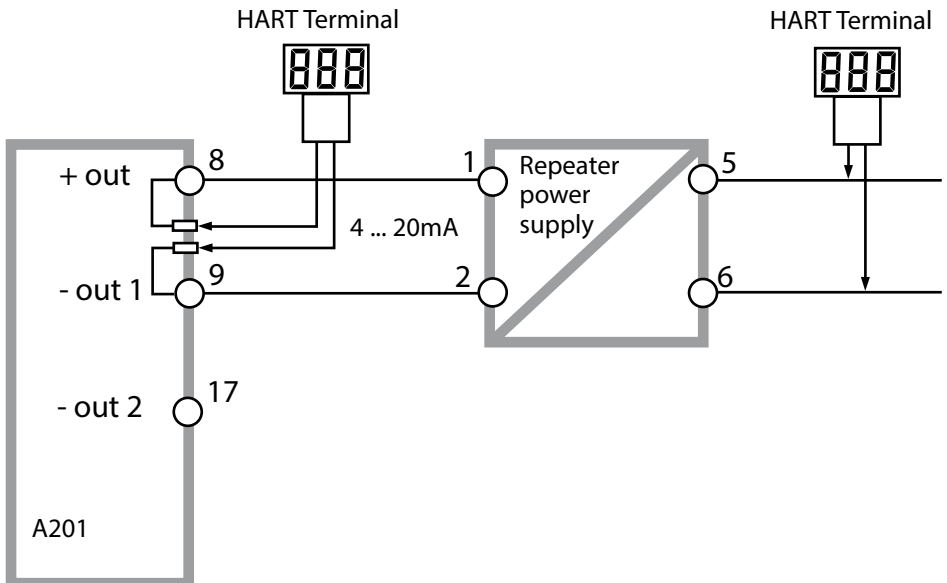
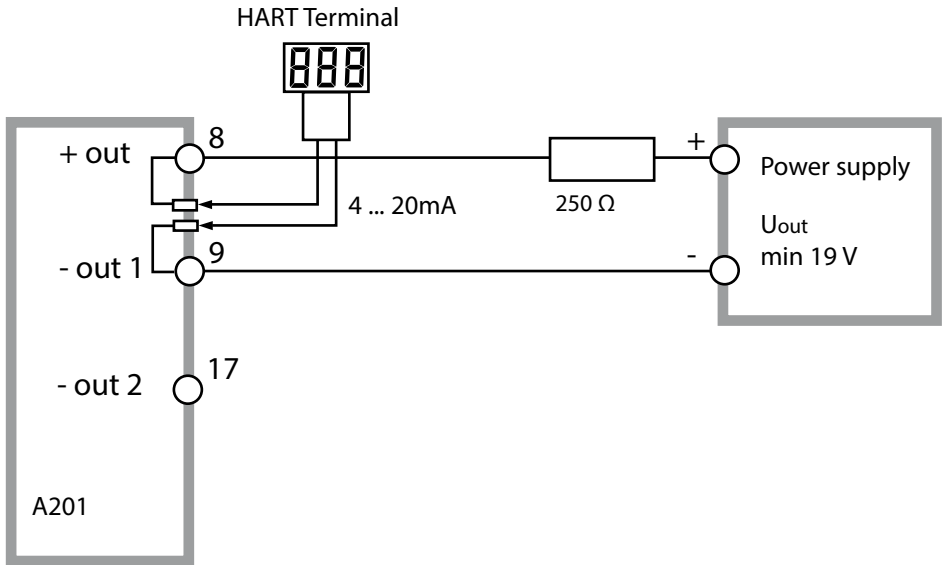

# FDA 21 CFR Part 11

---

## **Conformity with FDA 21 CFR Part 11**

In their directive “Title 21 Code of Federal Regulations, 21 CFR Part 11, Electronic Records; Electronic Signatures” the American health agency FDA (Food and Drug Administration) regulates the production and processing of electronic documents for pharmaceutical development and production. This results in requirements for measuring devices used for corresponding applications. The following features ensure that the measuring devices of this Series meet the demands of FDA 21 CFR Part 11:

### **Electronic Signature – Passcodes**

Access to the device functions is regulated and limited by individually adjustable codes – “Passcodes” (see SERVICE). This prevents unauthorized modification of device settings or manipulation of the measurement results. Appropriate use of these passcodes makes them suitable as electronic signature.

### **Audit Trail**

Every (manual) change of device settings can be automatically documented. Each change is tagged with a “Configuration Change Flag”, which can be interrogated and documented using HART communication. Altered device settings or parameters can also be retrieved and documented using HART communication.

### **Extended logbook (TAN SW-A003)**

Audit Trail also records function activations (CAL, CONFIG, SERVICE), some Sensoface messages (cal timer, wear, SIP, CIP) and opening of the enclosure.

## A

Access code assignment 107  
Accessories 111  
Activating an option 107  
Adaptive maintenance timer: reset 106  
Alarm 32  
Alarm and HOLD messages 33  
Alarm: setting a delay time 72  
Alarm settings, CONTROL input 74  
Ambulance TAN 107  
Assembly 13  
Asymmetry potential 93  
Audit Trail 142  
Autoclaving counter: configuration 52  
Autoclaving counter: description 53  
Autoclaving counter, error message 140  
Autoclaving counter: increment 106  
Automatic calibration (Calimatic) 88

## B

Backlighting 24  
Block diagram 12  
Buffer tables 117

## C

Cable glands 17  
Calibration 84  
Calibration, automatic calibration (Calimatic) 88  
Calibration, configuration 46  
Calibration data 101  
Calibration, data entry of premeasured sensors 92  
Calibration errors 133  
Calibration, general 29  
Calibration, ISFET sensors 84  
Calibration, manual calibration with buffer entry 90  
Calibration mode 85  
Calibration mode, selection 47  
Calibration, product calibration 94  
Calibration, redox calibration 96

Calibration, temperature probe adjustment 98  
Calibration timer 49  
Calibration timer, Sensoface 139  
Calibration, zero adjustment 87  
Calimatic 88  
CIP (cleaning cycles) 51  
CIP, error message 140  
Cleaning cycles 51  
Cleaning cycles, ISM sensor: configuration 50  
Commissioning 7  
Configuration: alarm 72  
Configuration: calibration mode 46  
Configuration: calibration timer 48  
Configuration: cleaning cycles 50  
Configuration: current output 2 64  
Configuration, display backlighting 78  
Configuration, general 29  
Configuration, individual settings (for copy) 42  
Configuration, measuring point 78  
Configuration, menu groups 35  
Configuration, menu structure 34  
Configuration: output current during HOLD 62  
Configuration: output current for error message or Sensoface 60  
Configuration: Sensocheck 72  
Configuration: sensor 44  
Configuration: sensor verification (TAG, GROUP) 54  
Configuration: sterilization cycles 50  
Configuration: temperature 44  
Configuration: temperature compensation 66  
Configuration, time and date 76  
Connection to supply units 110  
CONTROL, alarm settings 74  
Control drawings 3  
CONTROL input 33  
CONTROL input, configuration 70  
Control inputs 11  
Converting slope to mV 93



- Current output 1, configuring 56
- Current output 2, configuring 64

## D

- Data entry of premeasured sensors 92
- Data logger, explanation 10
- Date and time (configuration) 76
- Date and time (usage) 77
- Date, display 99
- Declaration of Conformity 3
- Decommissioning 137
- Device self-test 102
- Device type, display 104
- Diagnostics 100
- Diagnostics, calibration data 101
- Diagnostics, device self-test 102
- Diagnostics, general 29
- Diagnostics, logbook 103
- Diagnostics, sensor data 101
- Diagnostics, sensor monitor 104
- Diagnostics, version 104
- Digital sensors: operation and connection 80
- Digital sensors: sensor type selection 45
- Dimensions 14
- Display 24
- Display backlighting 24
- Display test 102
- Disposal 137
- Documentation: package contents 3

## E

- EEPROM test 102
- Electrical installation 17
- Electronic Signature 142
- Enabling an option 107
- Enclosure 14
- Enclosure components 13
- Entering values 26

Error handling 133  
Error messages 134  
EU Declaration of Conformity 3  
Extended logbook, Audit Trail 142  
Extended logbook, diagnostics 103  
External temp measurement via current input 68

## F

FACE: Sensoface alert, 22 mA output current 61  
FAIL: error message, 22 mA output current 61  
FDA 21 CFR Part 11 142  
FLASH test 102  
FLOW 71  
Flow measurement: alarm 74  
Flow measurement: configuration 70

## G

GROUP (measuring points) 79

## H

HART, typical applications 141  
HOLD: configuration 63  
HOLD mode, description 31  
HOLD mode, exit 31  
HOLD mode, external activation 32  
HOLD mode, manual activation 32  
HOLD mode, output signal 31

## I

Individual configuration data 42  
Info text 134  
Installation, notices 17  
Intended use 7

## K

Keypad 23

**L**

- Linear temperature compensation 67
- Logbook, diagnostics 103

**M**

- Maintenance 109
- Manual calibration with buffer entry 90
- Manual switchover of parameter sets A/B 36
- Measured values, display 104
- Measuring mode 99
- Measuring mode, overview 25
- Measuring points (TAG/GROUP) 79
- Memosens: configuring the device 81
- Memosens: connection 82
- Memosens, connection via RS-485 20
- Memosens sensors: calibration and maintenance in the lab 80
- Memosens sensors: operation and connection 80
- Memosens, wiring example 22
- MemoSuite software for calibrating Memosens sensors 80
- Menu structure 30
- Menu structure of configuration 34
- Message via CONTROL input 33
- Mounting options 9
- Mounting plan 14

**O**

- Operating modes 29
- Operating mode, selection 26
- Operating states, overview 108
- Option request 107
- Options, overview 111
- Order code 111
- Output current for error message (FAIL) 61
- Output current for Sensoface (FACE) 61
- Output current range 1, configuring 56
- Output current range 2, configuring 64
- Output current, specify value 106
- Output filter 58

Output signal during HOLD 31  
Output signal during HOLD, configuration 63  
Overview, device properties 9  
Overview, terminal assignments 12

## **P**

Package contents 13  
Package contents: documentation 3  
Panel mounting 16  
Parameter error 133  
Parameter set A/B 35  
Parameter set A/B, display 99  
Parameter set A/B, individual settings 42  
Parameter set A/B, introduction 10  
Parameter set selection 36  
Parameter set selection via external signal 70  
Pfaudler sensors 41  
Pipe mounting 15  
Power supply units 110  
Predictive maintenance (Memosens) 81  
Presetting pH calibration 85  
Process variable for current output 1 56  
Process variable for current output 2 64  
Product calibration 94  
Product line 111  
Protective hood 15

## **Q**

Quickstart guides 3

## **R**

RAM test 102  
Rated operating conditions 116  
Rating plates 18  
Redox calibration 96  
Repair 109  
Reset to factory settings 107  
Returns 137

**S**

- Safety 7
- Safety guide 3
- Selection menu 26
- Sensocheck 138
- Sensocheck: configuration 72
- Sensoface 138
- Sensoface alerts 61
- Sensoface, troubleshooting 133
- Sensor connection 19
- Sensor data, display 101
- Sensor defect, Sensoface 139
- Sensor monitor (diagnostics) 104
- Sensor monitor (Service) 106
- Sensor type selection 44
- Sensor verification (TAG, GROUP) 55
- Sensor wear, Sensoface 140
- Serial number, display 104
- Service 105
- Service, factory setting 107
- Service, general 29
- Service, incrementing the autoclaving counter 106
- Service, output current, specify value 106
- Service, passcode assignment 107
- Service passcode lost 107
- Service: reset TTM interval 106
- Service, sensor monitor 106
- Settings of U1 buffer set 132
- Setting the passcodes 107
- Signal colors 24, 28
- Signal lines 19
- Signal outputs 11
- SIP, error message 140
- SIP (sterilization cycles) 51
- Software version, display 104
- Solution Ground - and Memosens 80
- Specifiable buffer set, -U1- 130
- Specifications 112

Sterilization cycles 51  
Supplemental directives 2  
Supply units 110

## **T**

Tag number, display 99  
TAG (point of measurement) 79  
TAN input 107  
TAN options, activation 107  
TAN options, overview 111  
TC table 67  
Technical data 112  
Temperature compensation 67  
Temperature compensation, table 67  
Temperature dependence of reference systems measured against SHE 96  
Temperature detection during measurement 44  
Temperature detection for calibration 47  
Temperature measurement via current input 69  
Temperature probe adjustment 98  
Terminal assignments 18  
Terminal assignments, overview 12  
Test report 2.2 3  
Time and date (configuration) 76  
Time and date (usage) 77  
Time averaging filter 59  
Time, display 99  
Transaction number (TAN) 107

## **U**

U1, specifiable buffer set 130  
User interface 23

## **W**

Weather protector 15

Wiring 19

Wiring examples 21

Wiring, power supply units 110

## **Z**

Zero adjustment (ISFET) 86



**Knick**  
**Elektronische Messgeräte**  
**GmbH & Co. KG**

**Headquarters**

Beuckestraße 22 • 14163 Berlin

Germany

Phone: +49 30 80191-0

Fax: +49 30 80191-200

info@knick.de

www.knick.de

**Local Contacts**

www.knick-international.com

Translation of the original instructions

Copyright 2022 • Subject to change

Version: 5 • This document was published on February 18, 2022.

The latest documents are available for download on our website under the corresponding product description.



099455

TA-212.115-MS-KNEN05