

Stratos Pro A201MSCONDI

Conductivity Measurement
with Toroidal Sensors via Memosens Protocol

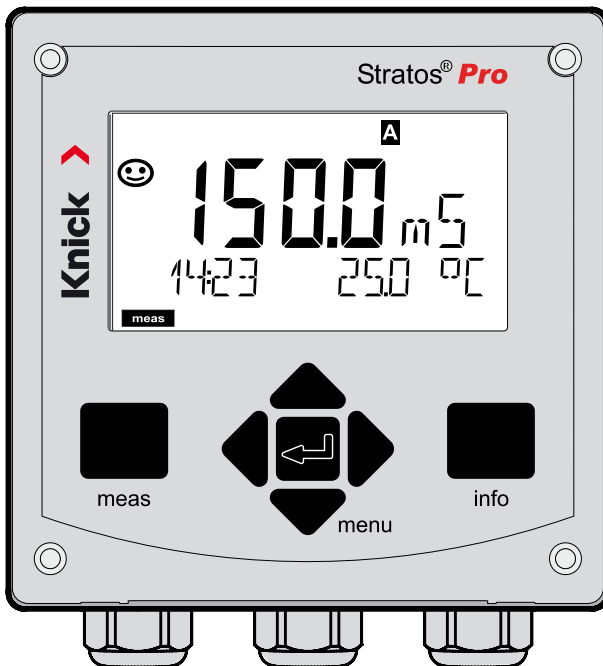

Read before installation.
Keep for future use.

Supplemental Directives

Read this document and retain it for future reference. Before assembling, installing, operating, or maintaining the product, ensure that you fully understand the instructions and risks. Observe all safety instructions. Failure to follow the instructions in this document may result in serious injury and/or property damage.

This document is subject to change without notice.

These supplemental directives explain how safety information is laid out in this document and what content it covers.

Safety Chapter



This document's Safety chapter is designed to give the reader a basic understanding of safety. It illustrates general hazards and gives strategies on how to avoid them.

Safety Guide

The external Safety Guide is designed to give the reader a basic understanding of safety. It illustrates general hazards and suggests strategies on how to avoid them.

Warnings

This document uses the following warnings to indicate hazardous situations:

Symbol	Category	Meaning	Remark
	WARNING	Designates a situation that can lead to death or serious (irreversible) injury.	The warnings contain information on how to avoid the hazard.
	CAUTION	Designates a situation that can lead to slight or moderate (reversible) injury.	
None	NOTICE	Designates a situation that can lead to property or environmental damage.	

Additional Safety Information

Stratos Safety Guide

Safety Guide

In official EU languages and others

Quickstart Guides

Installation and first steps:

- Operation
- Menu structure
- Calibration
- Error messages and recommended actions

Test Report 2.2 According to EN 10204

Electronic Documentation

www.knick-international.com:

Manuals + software

Ex devices:

Control Drawings

EU Declaration of Conformity

Table of Contents

Supplemental Directives	2
Documents Supplied	3
Safety	7
Intended Use	7
Introduction	9
Overview of Stratos Pro A201MSCONDI	12
Assembly	13
Package Contents	13
Mounting Plan, Dimensions	14
Pipe Mounting, Protective Hood.....	15
Panel Mounting	16
Electrical Installation	17
Rating Plates / Terminal Assignments.....	18
Wiring of Stratos Pro A201MSCONDI.....	19
Wiring Example: SE670, SE680	20
User Interface, Keypad	21
Display	22
Signal Colors (Display Backlighting)	22
Measuring Mode	23
Selecting the Mode / Entering Values.....	24
Display in Measuring Mode	25
Color-Coded User Interface	26
Operating Modes	27
Menu Structure of Modes and Functions	28
HOLD Mode	29
Alarm	30
Alarm and HOLD Messages.....	31

Configuration	32
Menu Structure of Configuration.....	32
Manual Switchover of Parameter Sets A/B.....	34
Configuration (Template for Copy)	39
Sensor.....	42
Sensor Verification (TAG, GROUP)	50
Current Output 1	52
Current Output 2.....	62
Temperature Compensation.....	64
CONTROL Input (TAN SW-A005).....	68
Alarm Settings.....	70
Time and Date.....	74
Measuring Points (TAG/GROUP)	76
Display Backlighting	76
Calibration	79
Selecting a Calibration Mode	79
Calibration with Calibration Solution.....	80
Calibration by Input of Cell Factor.....	82
Calibration by Input of an Installation Factor.....	83
Product Calibration	84
Zero Calibration in Air	86
Temp Probe Adjustment	87
Measurement	88
Diagnostics	89
Service	95
Operating States	98
Maintenance and Repair	100
A201B/X: Supply Units and Connection	101

Table of Contents

Product Line and Accessories	102
Specifications	103
Calibration Solutions	109
Concentration Measurement	111
Concentration Curves.....	112
Error Handling.....	117
Error Messages.....	118
Decommissioning.....	121
Disposal	121
Returns.....	121
Sensoface	122
HART: Typical Applications.....	124
FDA 21 CFR Part 11	125
Electronic Signature – Passcodes.....	125
Audit Trail.....	125
Index	126

Always Read and Observe the Safety Instructions!

The device is constructed in accordance with the latest technology and generally accepted safety rules and regulations.

Under certain circumstances, however, usage may pose risks to users or cause damage to the device.

Commissioning must be carried out by specialist personnel authorized by the operating company. If safe operation is not possible, the device must not be switched on or, if it is already on, must be switched off properly and secured against unintended operation.

Reasons to assume safe operation is not possible:

- the device shows visible damage
- failure to perform the intended function
- prolonged storage at temperature of below -30 °C/-22 °F or above 70 °C/158 °F
- severe transport stresses

Before recommissioning the device, a professional routine test must be performed. This test should be carried out by the manufacturer at its factory.

Intended Use

Stratos Pro AMS201CONDI is a 2-wire device for measurement of electrical conductivity and temperature in liquids using toroidal (electrodeless) sensors. Fields of application are: biotechnology, chemical industry, environment, food processing, water/wastewater treatment.

Stratos Pro A201X and the separately approved Ex sensor may be operated in Zone 0 / Division 1.

Stratos Pro A201B and the separately approved Ex sensor may be operated in Zone 2.

The defined rated operating conditions must be observed when using this product. They can be found in the Specifications chapter of this User Manual; see page 103.

Safety

Function Check Mode (HOLD Function)

After activating configuration, calibration, or service, Stratos Pro enters function check mode (HOLD).

The current outputs respond in accordance with the configuration.

Operations must not be carried out while Stratos Pro is in function check (HOLD) mode, as the system may behave unexpectedly and put users at risk.

Control Drawings

If installing in hazardous locations, observe the information provided on the included Control Drawings.

Devices Not Intended for Use in Hazardous Locations

Devices identified with an N in their product name must not be used in hazardous locations.

Configuration

Replacing components may affect intrinsic safety. The modules are not intended to be replaced on devices in the Stratos Pro A201 product line.

Housing and Mounting Options

- The sturdy molded enclosure is designed for IP66/IP67 / TYPE 4X Outdoor protection, is made of PBT glass fiber reinforced PC, and has the following dimensions: H 148 mm, W 148 mm, T 117 mm. Knockouts in the housing enable
- wall mounting (with sealing plugs to seal the housing)
see page 14
- pipe mounting (Ø 40 ... 60 mm, □ 30 ... 45 mm)
see page 15
- panel mounting (cutout 138 mm x 138 mm acc. to DIN 43700)
see page 16

Protective Hood (Accessory)

The protective hood, which is available as accessory, provides additional protection against direct weather exposure and mechanical damage; see page 15.

Connection of Sensors, Cable Glands

For connecting the cables, the enclosure provides

- 3 knockouts for M20x1.5 cable glands
- 2 knockouts for ½" conduit

For quasi-stationary installations with Memosens sensors, we recommend using the M12 socket accessory (ZU0822) instead of a cable gland – which allows simple replacement of the sensor cable without opening the device.

Sensors

The device has been designed for application with the Model SE670 and SE680 toroidal sensors (Knick).

Display

Plain-text messages on a large, backlit LC display enable intuitive operation. You can specify which values are to be displayed in standard measuring mode (“Main Display,” see page 25).

Color-Coded User Interface

The colored display backlighting indicates different operating states (e.g., alarm: red, HOLD mode: orange; see page 26). The display backlighting can be switched off; see page 76.

Diagnostic Functions

“Sensocheck” automatically monitors sensor and cables; and the “Sensoface” function clearly indicates the sensor condition; see page 122.

Data Logger

The internal logbook (TAN SW-A002) can handle up to 100 entries – up to 200 with AuditTrail (TAN SW-A003); see page 92.

Two Parameter Sets A, B

The device provides two parameter sets that can be switched manually or via a control input for different process connections or different process conditions.

For an overview of parameter sets (original for copy), see page 39.

Password Protection

Password protection (passcodes) for granting access rights during operation can be configured; see page 97.

TC process medium: Selecting the compensation method

The following temperature compensation methods are provided: linear (by entering a temperature coefficient), natural waters (nLF), ultrapure water with traces of NaCl, HCl, NH₃, NaOH, see page 64.

Control Inputs (TAN SW-A005)

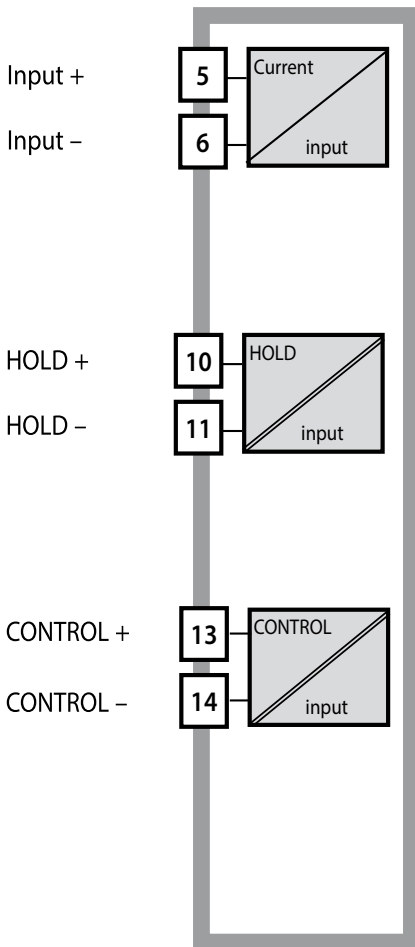

I input

The analog (0) 4 ... 20 mA current input can be used for external temperature compensation; see page 64.

HOLD

(Floating digital control input)
The HOLD input can be used for external activation of HOLD mode; see page 29.

CONTROL

(Floating digital control input)
The CONTROL input can be used either for parameter set selection (A/B) or for flow monitoring; see page 68.

Signal Outputs

The device provides two current outputs (for transmission of measured value and temperature, for example). The output curve is adjustable (linear, bilinear or logarithmic), see page 54.

Options

Additional functions can be enabled by entering a TAN (p. 97).

Overview

Overview of Stratos Pro A201MSCONDI

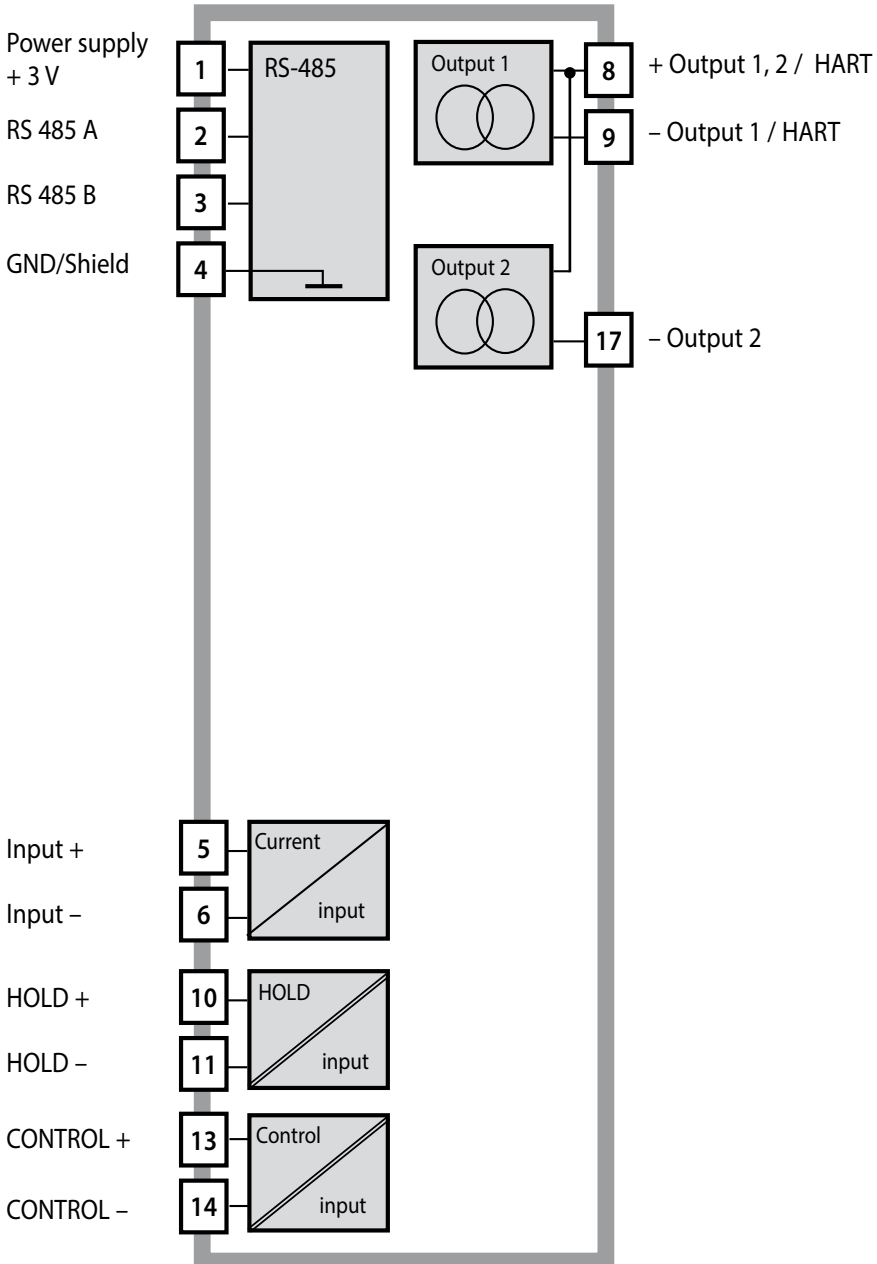

Package Contents

Note: Check all components for damage upon receipt.
Do not use damaged parts.

The package should contain:

- Front unit, rear unit, bag containing small parts
- Specific test report
- Documentation (see page 3)

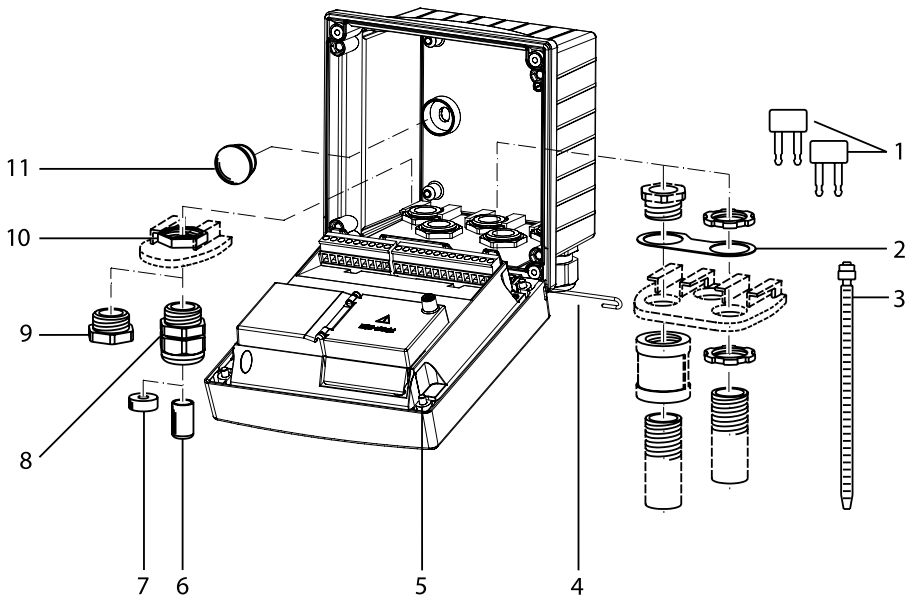

Fig.: Assembling the enclosure

- | | |
|--|---|
| 1) Insertable jumper (3x) | 6) Blanking plug (2x, non-Ex only) |
| 2) Plate (1x), for conduit mounting: Plate between housing and nut | 7) Reduction sealing insert (1x) |
| 3) Cable tie (3x) | 8) Cable gland (3x) |
| 4) Hinge pin (1x), insertable from either side | 9) Blanking cap (2x) |
| 5) Enclosure screw (4x) | 10) Hex nut (5x) |
| | 11) Plastic sealing plug (2x), for sealing in case of wall mounting |

Mounting Plan, Dimensions

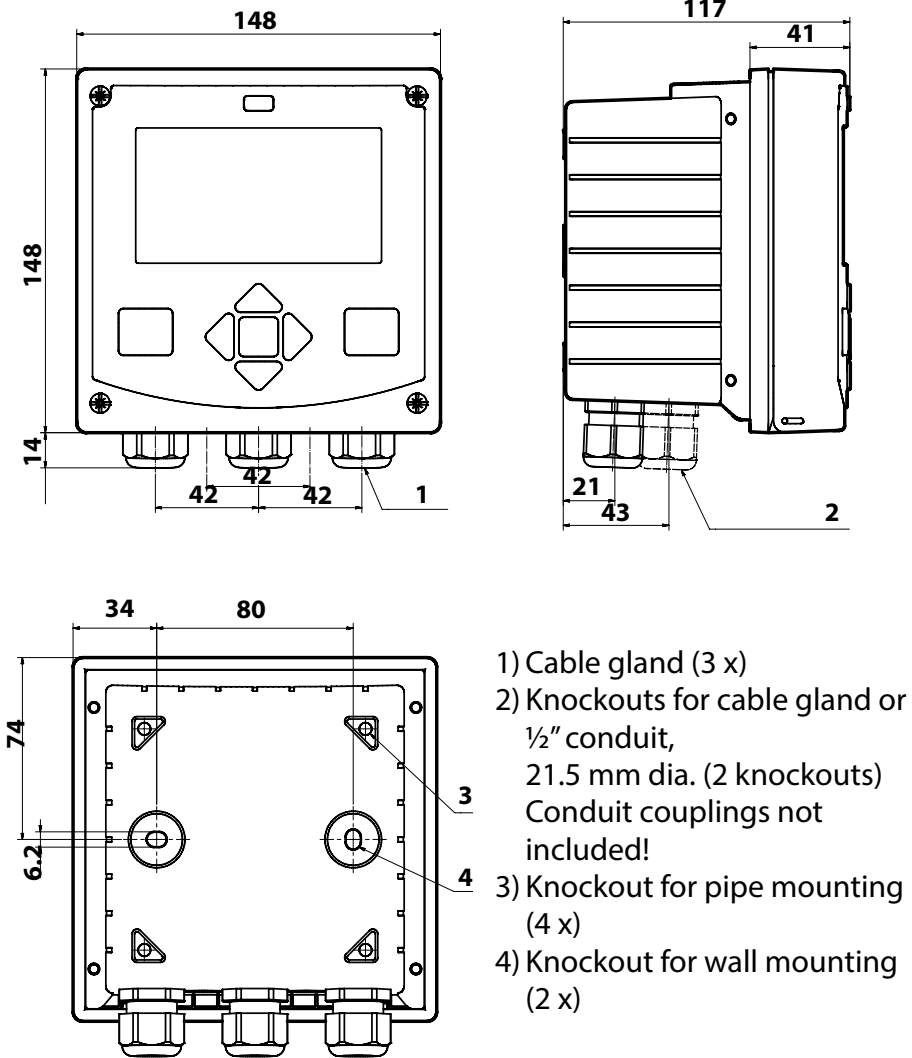
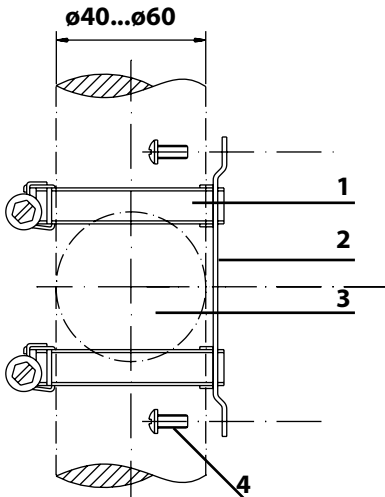

Fig.: Mounting plan (All dimensions in mm!)

Pipe Mounting, Protective Hood



- 1) Hose clamp with worm gear drive to DIN 3017 (2 x)
- 2) Pipe-mount plate (1 x)
- 3) For vertical or horizontal posts or pipes
- 4) Self-tapping screw (4 x)

Fig.: Pipe-mount kit, accessory ZU 0274 (All dimensions in mm!)

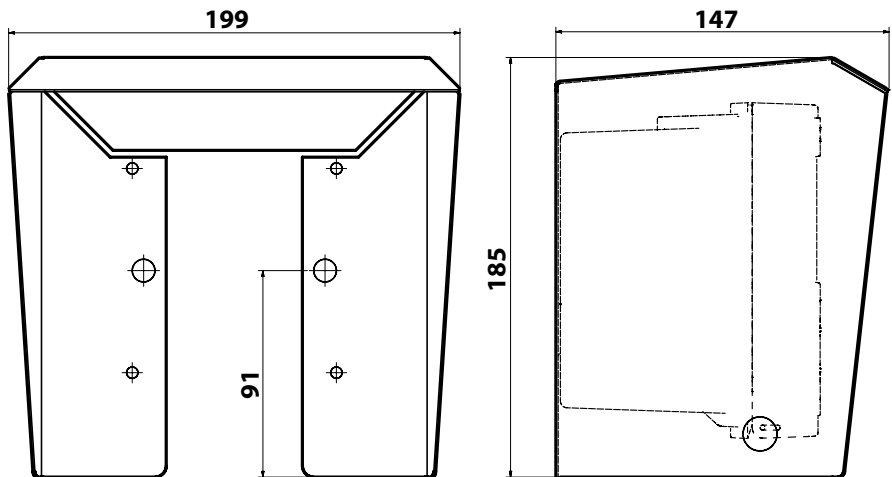
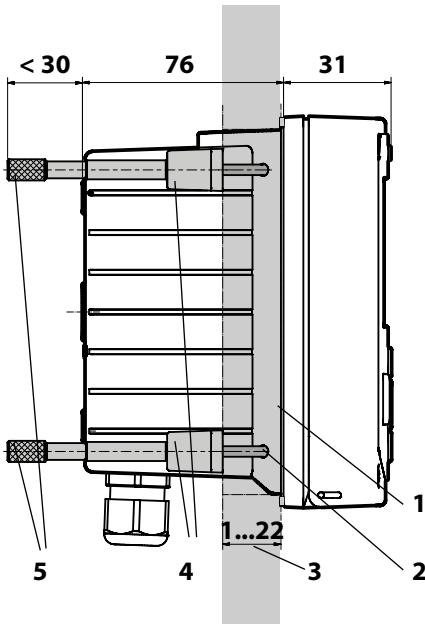

Fig.: Protective hood for wall and pipe mounting, accessory ZU 0737 (All dimensions in mm!)

Panel Mounting



- 1) Circumferential sealing (1 x)
- 2) Screws (4 x)
- 3) Position of control panel
- 4) Span piece (4 x)
- 5) Threaded sleeve (4 x)

Cutout

138 x 138 mm (DIN 43700)

Fig.: Panel-mount kit, accessory ZU 0738 (All dimensions in mm!)

Electrical Installation

Before commencing with the installation, make sure that all lines to be connected are de-energized.

Observe the safety instructions; see page 7.

Cable Glands

In a hazardous location, only cable glands with suitable approvals may be used. The installation instructions of the manufacturer must be observed.

Cable glands	5 cable glands M20 x 1.5 A/F 24 mm WISKA type ESKE/1 M20
Clamping ranges	Standard sealing insert: 7 ... 13 mm
	Reduction sealing insert: 4 ... 8 mm
	Multiple sealing insert: 5.85 ... 6.5 mm
Tensile strain	Not permitted; Only suitable for "fixed installation"

⚠ CAUTION! Risk of losing the specified ingress protection.

Fasten the cable glands and screw together the housing correctly.

Observe the permissible cable diameters and tightening torques.

Only use original accessories and spare parts.

NOTICE! Strip the insulation from the wires using a suitable tool to prevent damage. For stripping length, see Specifications.

- 1) Wire the current outputs. Deactivate unused current outputs in the parameter settings or use jumpers.
- 2) Wire the inputs as necessary.
- 3) Connect the sensor.
- 4) Check whether all connections are correctly wired.
- 5) Close the housing and successively tighten the enclosure screws in a diagonal pattern.

Rating Plates / Terminal Assignments

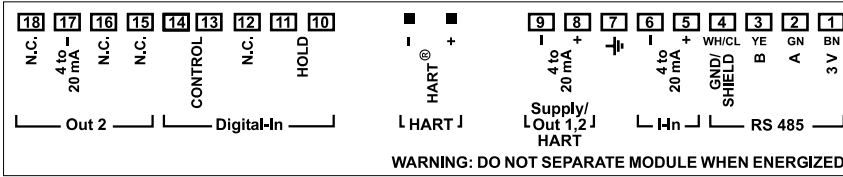

Fig.: Terminal assignments of Stratos Pro A201

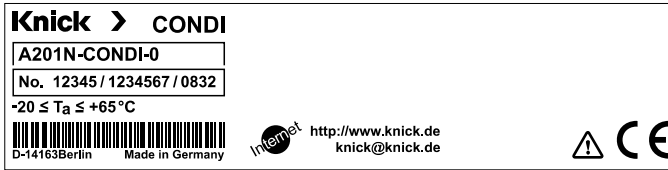
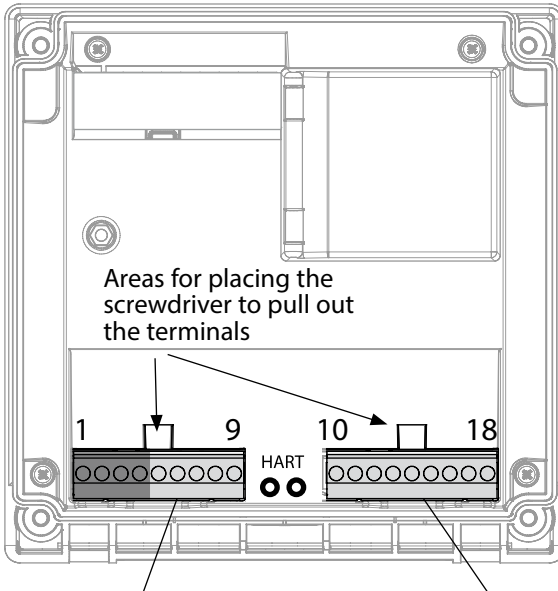

Fig.: Stratos Pro A201N rating plate at outside bottom of front (illustrative example)

Wiring of Stratos Pro A201MSCONDI



Terminal row 1		
1 (BN)	+3 V	⚠
2 (GN)	RS 485 A	⚠
3 (YE)	RS 485 B	⚠
4 (WH)	GND/shield	⚠
5	+ input	
6	- input	
7	PA	
8	+out 1,2/HART	
9	- out 1/HART	

Terminal row 2	
10	hold
11	hold
12	n.c.
13	contr
14	contr
15	n.c.
16	n.c.
17	- out 2
18	n.c.

In addition:

2 HART pins (between terminal row 1 and 2)

⚠ Sensor connection RS-485

Fig.: Terminals, device opened, back of front unit

Wiring Example: SE670, SE680

Measuring task: Conductivity, temperature

Sensor: SE670, SE680

NOTICE! Connection to RS-485 interface!

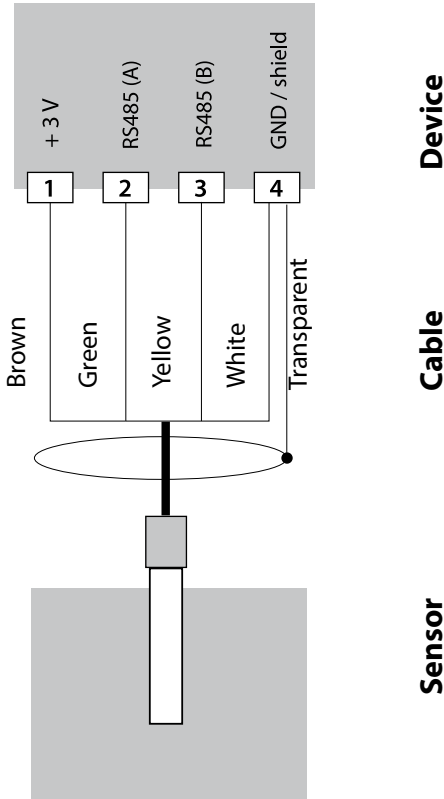

The SE670 / SE680 sensors are connected to the RS-485 interface of the device – for an A2... Series (2-wire) device, the measuring module slot must be empty. Therefore, first remove the measuring module from the slot (see next page). When the sensor model SE670 / SE680K is selected in the Configuration menu, the default values are taken as calibration data. They can then be modified by calibration. All calibration data of the SE680M sensor with Memosens protocol are stored in the sensor.

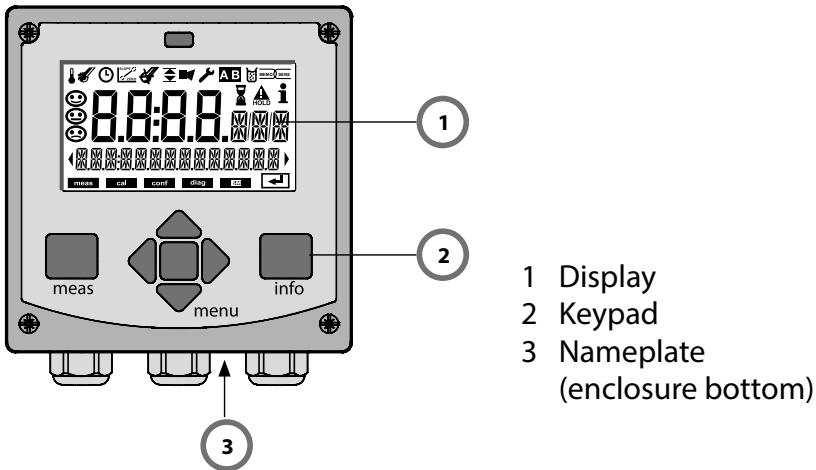

User Interface, Keypad

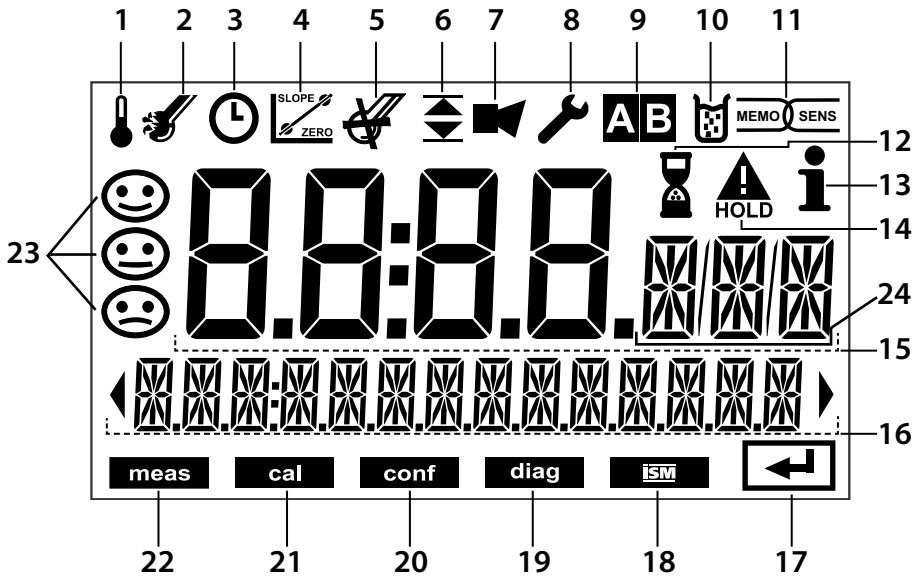

Key	Function
meas	<ul style="list-style-type: none">• Return to last menu level• Directly to measuring mode (press > 2 s)• Measuring mode: other display
info	<ul style="list-style-type: none">• Retrieve information• Show error messages
enter	<ul style="list-style-type: none">• Configuration: Confirm entries, next configuration step• Calibration: Continue program flow
menu	<ul style="list-style-type: none">• Measuring mode: Call menu
Arrow keys up / down	<ul style="list-style-type: none">• Menu: Increase/decrease a numeral• Menu: Selection
Arrow keys left / right	<ul style="list-style-type: none">• Previous/next menu group• Number entry: Move between digits

Display



- | | | | |
|----|--|----|---------------------|
| 1 | Temperature | 13 | Info available |
| 2 | Sensocheck | 14 | Hold mode active |
| 3 | Interval/response time | 15 | Main display |
| 4 | Sensor data | 16 | Secondary display |
| 5 | Not used | 17 | Proceed using enter |
| 6 | Limit message:
Limit 1  or Limit 2  | 18 | Not used |
| 7 | Alarm | 19 | Diagnostics |
| 8 | Service | 20 | Configuration mode |
| 9 | Parameter set | 21 | Calibration mode |
| 10 | Calibration | 22 | Measuring mode |
| 11 | Memosens | 23 | Sensoface |
| 12 | Waiting time running | 24 | Unit symbols |

Signal Colors (Display Backlighting)

- | | |
|--------------|---|
| Red | Alarm (in case of fault: display values blink) |
| Red blinking | Input error: illegal value or wrong passcode |
| Orange | HOLD mode (Calibration, Configuration, Service) |
| Turquoise | Diagnostics |
| Green | Info |
| Magenta | Sensoface message |

Measuring Mode

After the operating voltage has been connected, the analyzer automatically goes to "Measuring" mode. To call the measuring mode from another operating mode (e.g. Diagnostics, Service): Hold **meas** key depressed (> 2 s).

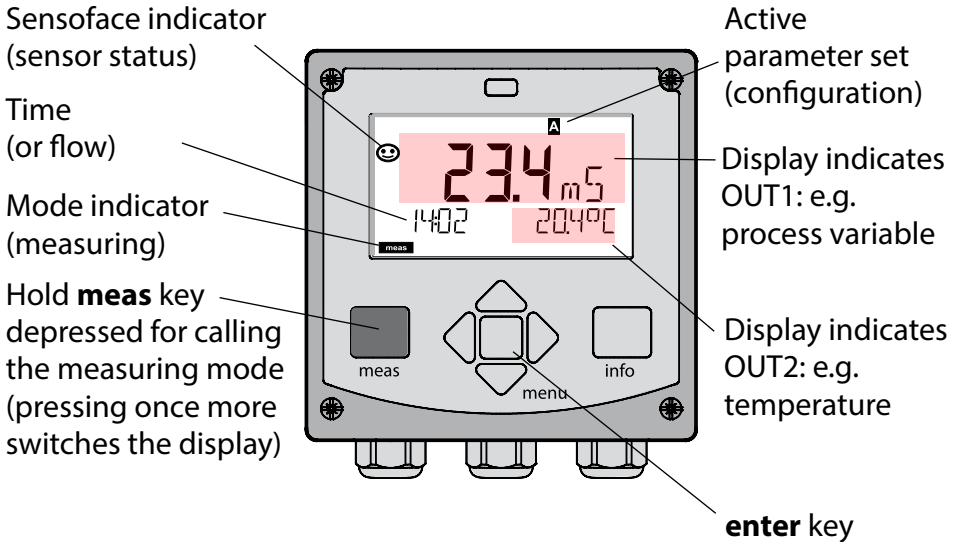

Depending on the configuration, one of the following displays can be set as standard display for the measuring mode (see page 25):

- Measured value, time and temperature (default setting)
- Measured value and selection of parameter set A/B or flow
- Measured value and measuring point ("TAG")
- Time and date

Note: By pressing the **meas** key in measuring mode you can view the displays for approx. 60 sec.



The device must be configured for the respective measurement task, see page 32.

Selecting the Mode / Entering Values

To select the operating mode:

- 1) Hold **meas** key depressed (> 2 s) (directly to measuring mode)
- 2) Press **menu** key: the selection menu appears
- 3) Select operating mode using left / right arrow key
- 4) Press **enter** to confirm the selected mode

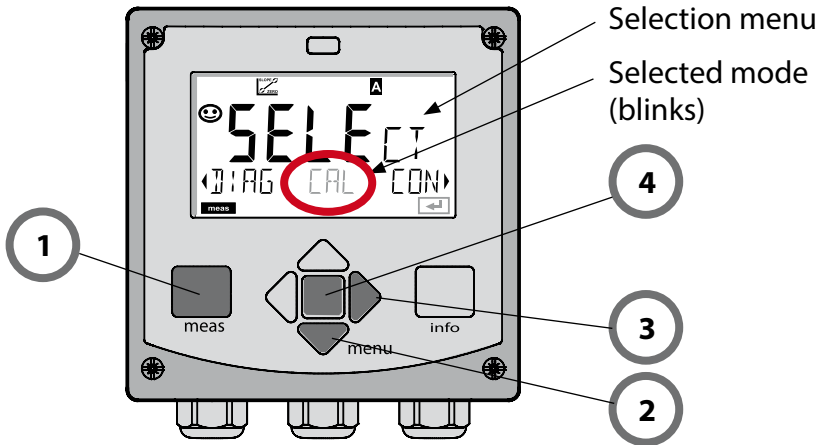

To enter a value:

- 5) Select numeral: left / right arrow key
- 6) Change numeral: up / down arrow key
- 7) Confirm entry by pressing **enter**

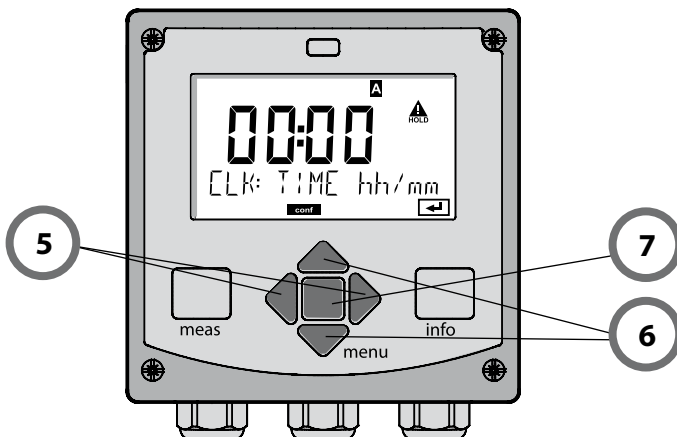

Display in Measuring Mode

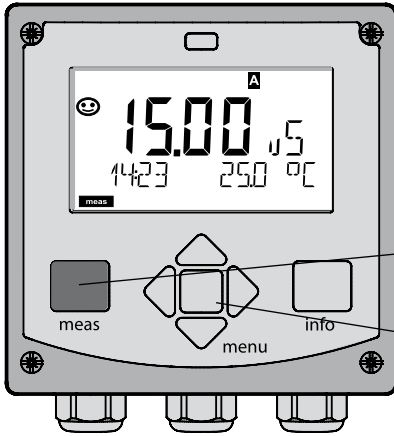

The MAIN DISPLAY is the display which is shown in measuring mode. To call the measuring mode from any other mode, hold the **meas** key depressed for at least 2 sec.

meas key

enter key



By pressing **meas** briefly you can step through further displays such as tag number (TAG) or flow (L/h). These displays are turquoise. After 60 sec they switch back to the main display.

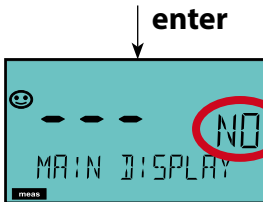
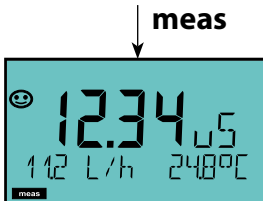

Press **enter** to select a display as MAIN DISPLAY – the secondary display shows “MAIN DISPLAY – NO”. Use the **UP / DOWN** arrow keys to select “MAIN DISPLAY – YES” and confirm by pressing **enter**. The display color changes to white. This display is now shown in measuring mode.



Color-Coded User Interface

The color-coded user interface* guarantees increased operating safety. Operating modes are clearly signaled.

The normal measuring mode is white. Information text appears on a green screen and the diagnostic menu appears on turquoise.

The orange HOLD mode (e.g. during calibration) is quickly visible as is the magenta screen which indicates asset management messages for predictive diagnostics – such as maintenance request, pre-alarm and sensor wear.

The alarm status has a particularly noticeable red display color and is also signaled by flashing display values. Invalid inputs or false pass-codes cause the entire display to blink red so that operating errors are noticeably reduced.

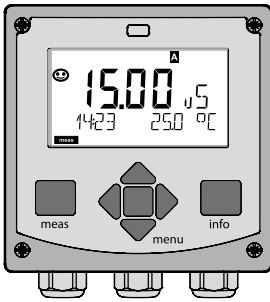

White:
Measuring mode

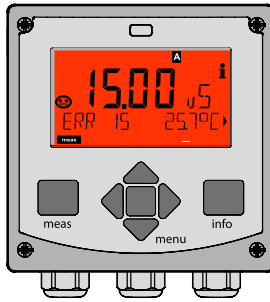

Red blinking:
Alarm, errors

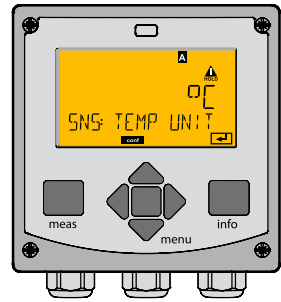

Orange:
HOLD mode

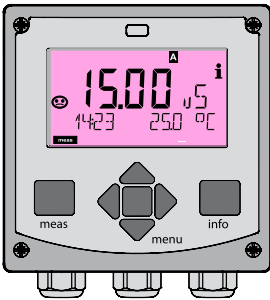

Magenta:
Maintenance request

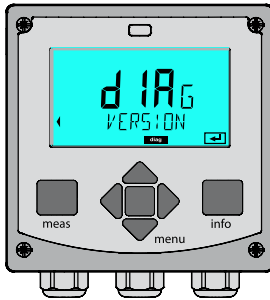

Turquoise:
Diagnostics

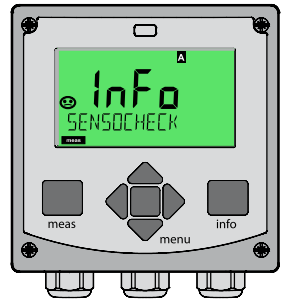

Green:
Information texts

Diagnostics

Display of calibration data, display of sensor data, performing a device self-test, viewing the logbook entries, display of hardware/software versions of the individual components. The logbook (TAN SW-A002) can store 100 events (00...99). They can be displayed directly on the device. With AuditTrail (TAN SW-A003), the logbook can be extended to 200 entries.

HOLD

Manual activation of HOLD mode, e.g. for servicing. The signal outputs adopt a defined state.

Calibration

Every sensor has typical characteristic values. Calibration is required to supply a correct measured value. The device checks which value the sensor delivers when measuring in a known solution. When there is a deviation, the device can be "adjusted". In that case, the device displays the "actual" value and internally corrects the measurement error of the sensor. During calibration the device is in HOLD mode.

During calibration the device remains in the HOLD mode until it is stopped by the operator.

Configuration

The analyzer must be configured for the respective measurement task. In the "Configuration" mode you select the connected sensor, the measuring range to be transmitted, and the conditions for warning and alarm messages. During configuration the device is in HOLD mode.

Configuration mode is automatically exited 20 minutes after the last keystroke. The device returns to measuring mode.

Service

Maintenance functions (current source), passcode assignment, reset to factory settings, enabling of options (TAN).

Menu Structure of Modes and Functions

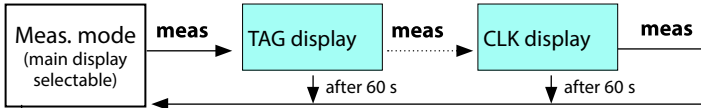

Pressing the **menu** key (down arrow) opens the selection menu. Select the menu group using the left/right arrow keys. Pressing **enter** opens a menu item. Press **meas** to return.

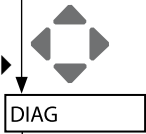

CALDATA	Display of calibration data
SENSOR	Display of sensor data
SELFTEST	Self test: RAM, ROM, EEPROM, module
LOGBOOK	Logbook: 100 events with date and time
MONITOR	Display of direct, uncorrected sensor signals
VERSION	Display of software version, model designation, serial number

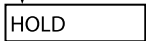

Manual activation of HOLD mode, e.g. for sensor replacement. The signal outputs behave as configured (e.g. last measured value, 21 mA)

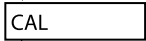

CAL_SOL	Calibration with calibration solution
CAL_CELL	Calibration by input of cell factor
CAL_ZERO	Zero calibration
P_CAL	Product calibration
CAL_RTD	Adjustment of temperature probe

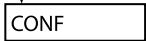

PARSET A	Configuring parameter set A
PARSET B	Configuring parameter set B



(Access via code, factory setting: 5555)

MONITOR	Display of measured values for validation (simulators)
OUT1	Current source, output 1
OUT2	Current source, output 2
CODES	Specifying access codes for operating modes
DEFAULT	Reset to factory setting
OPTION	Enabling an option via TAN

The HOLD mode is a safety state during configuration and calibration. Output current is frozen (LAST) or set to a fixed value (FIX). The HOLD mode is indicated by orange display backlighting.

HOLD mode, display icon:



Output signal response

- **LAST:** The output current is frozen at its last value. Recommended for short configuration procedures. The process should not change decisively during configuration. Changes are not noticed with this setting!
- **FIX:** The output current is set to a value that is noticeably different from the process value to signal the control system that the device is being worked at.

Output signal during HOLD:

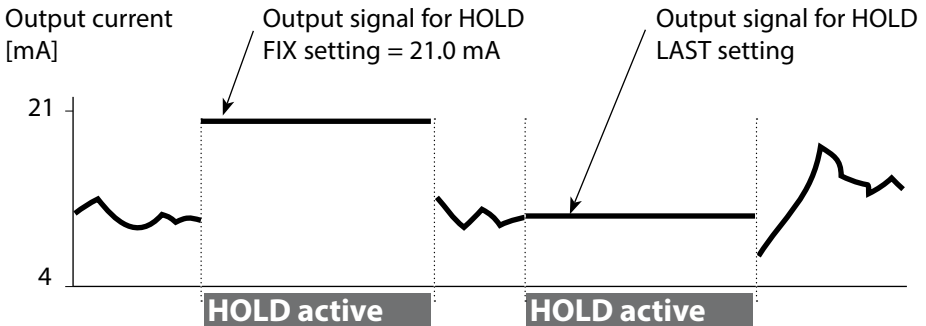

Terminating the HOLD mode

The HOLD mode is ended by switching to measuring mode (hold **meas** key depressed). The display reads “Good Bye”, after that, the HOLD mode is exited.

When the calibration mode is exited, a confirmation prompt ensures that the installation is ready for operation (e.g.: sensor reinstalled, located in process).

Alarm

External activation of HOLD (SW-A005)

The HOLD mode can be activated from outside by sending a signal to the HOLD input (e.g. from the process control system).

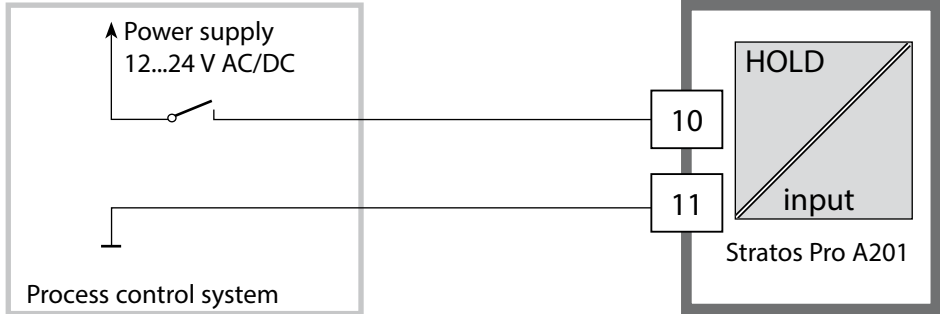

HOLD inactive	0...2 V AC/DC
HOLD active	10...30 V AC/DC

Manual activation of HOLD

The HOLD mode can be activated manually from the HOLD menu. This allows checking or replacing a sensor, for example, without provoking unintended reactions at the outputs.

Press **meas** key to return to selection menu.

Alarm

When an error has occurred, **Err xx** is displayed immediately.

Only after expiry of a user-defined delay time will the alarm be registered and entered in the logbook.

During an alarm the display blinks, the display backlighting turns **red**.

Error messages can also be signaled by a 22 mA output current (see Configuration).

2 sec after the failure event is corrected, the alarm status will be deleted.

Alarm and HOLD Messages

Message	Released by	Cause
Alarm (22 mA)	Sensocheck	Polarization / Cable
	Error Messages	Flow (CONTROL input) ERR 10: Conductance > 3500 mS
HOLD (Last/Fix)	HOLD	HOLD via menu or input
	CONF	Configuration
	CAL	Calibration
	SERVICE	Service

Generating a message via the CONTROL input (TAN SW-A005) (min. flow / max. flow)

The CONTROL input can be used for parameter set selection or for flow measurement (pulse principle), depending on its assignment in the "Configuration" menu.

When preset to flow measurement

CONF/CNTR_IN/CONTROL = FLOW

an alarm can be generated when the measured flow exceeds a specified range:

CONF/ALA/FLOW CNTR = ON

CONF/ALA/FLOW min (specify value, default: 5 liters/h)

CONF/ALA/FLOW max (specify value, default: 25 liters/h)

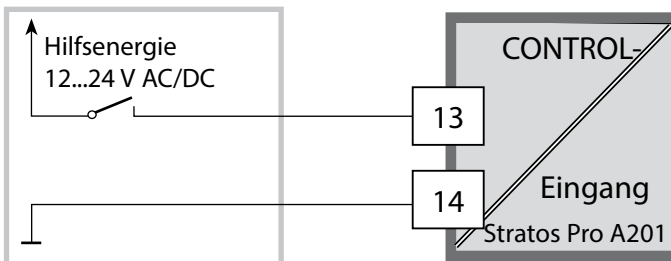

Configuration

⚠ CAUTION! Incorrect parameter settings or adjustments can result in incorrect outputs. Stratos Pro must therefore be commissioned by a system specialist, all its parameters must be set, and it must be fully adjusted. For detailed information on parameter setting and adjustment, see the user manual

Menu Structure of Configuration

The device provides 2 parameter sets "A" and "B". By switching between the parameter sets you can adapt the device to different measurement situations, for example. Parameter set "B" only permits setting of process-related parameters.

The configuration steps are assigned to different menu groups.

With the left/right arrow keys you can jump between the individual menu groups.

Each menu group contains menu items for setting the parameters.

Pressing **enter** opens a menu item. Use the arrow keys to edit a value.

Press **enter** to confirm/save the settings.

Return to measurement: Hold **meas** key depressed (> 2 s).



Select menu group	Menu group	Code	Display	Select menu item
	Sensor selection	SNS:		 enter enter enter enter
		Menu item 1		
		⋮		
		Menu item ...		
▶	Current output 1	OT1:		 enter
▶	Current output 2	OT2:		
▶	Compensation	COR:		
		
▶	Display backlighting	DSP:		

Parameter Set A/B: Configurable Menu Groups

Menu group	Parameter set A	Parameter set B
SENSOR	Sensor selection	---
OUT1	Current output 1	Current output 1
OUT2	Current output 2	Current output 2
CORRECTION	Compensation	Compensation
CNTR_IN	Control input	---
ALARM	Alarm mode	Alarm mode
PARSET	Parameter set selection	---
CLOCK	Setting the clock	---
TAG	TAG of measuring point	TAG of measuring point
GROUP	GROUP of measuring points	GROUP of measuring points
DISPLAY	Display backlighting	---

Configuration

Manual Switchover of Parameter Sets A/B

Display	Action	Remark
	To switch between parameter sets: Press meas .	Manual selection of parameter sets must have been preset in CONFIG mode. Default setting is a fixed parameter set A. Wrong settings change the measurement properties!
	PARSET blinks in the lower line. Select parameter set using ◀ and ▶ keys	
	Select PARSET A / PARSET B Press enter to confirm. Cancel by pressing meas	

Configuration		Choices	Default
Sensor (SENSOR)			
SNS:		MEMOSENS SE 680-M SE 670-K SE 670	MEMOSENS
MEAS MODE		Cond Conc % Sal ‰	Cond
Cond	MEAS RANGE	xxx.x µS/cm x.xxx mS/cm xx.xx mS/cm xxx.x mS/cm x.xxx S/m xx.xx S/m	x.xxx mS/cm
Conc	Solution	-01- (NaCl) -02- (HCl) -03- (NaOH) -04- (H2SO4) -05- (HNO3) -06- (H2SO4) -07- (HCl) -08- (HNO3) -09- (H2SO4) -10- (NaOH)	-01- (NaCl)
TEMP UNIT		°C / °F	°C
TEMPERATURE		AUTO, MAN, EXT (EXT. only with TAN option SW-A005)	AUTO
MAN	TEMPERATURE	-50 ... 250 °C (-58 ... 482 °F)	025.0 °C (077.0 °F)
CIP COUNT		ON/OFF ON	OFF 0 ... 9999 CYCLES
SIP COUNT		ON/OFF ON	OFF 0 ... 9999 CYCLES
CHECK TAG		ON/OFF	OFF
CHECK GROUP		ON/OFF	OFF

Configuration

Configuration		Choices	Default	
Output 1 (OUT1)				
OT1:	CHANNEL		Cond/TMP	Cond
	OUTPUT (with Cond only)		LIN / BiLIN / LOG	LIN
	LIN	BEGIN 4mA	xxxx	000.0 mS/cm
		END 20 mA	xxxx	100.0 mS/cm
	BiLIN	BEGIN 4 mA		
		END 20 mA		
		CORNER X	Input range: selected CHANNEL Vertex X : BEGIN ≤ CORNER X ≤ END (rising) BEGIN ≥ CORNER X ≥ END (falling)	
		CORNER Y	Input range: selected CHANNEL Default: 12 mA Vertex Y: (0) 4 mA ≤ CORNER Y ≤ 20 mA	
	LOG	BEGIN 4 mA	Decades	
		END 20 mA	Decades	
	TMP °C	BEGIN 4 mA	-50...250 °C	
		END 20 mA	-50...250 °C	
	TMP °F	BEGIN 4 mA	-58...482 °F	
		END 20 mA	-58...482 °F	
	FILTERTIME		0...120 SEC	0000 SEC
	22 mA FAIL		ON/OFF	OFF
	22 mA FACE		ON/OFF	OFF
HOLD MODE		LAST/FIX	LAST	
FIX	HOLD-FIX	4...22 mA	021.0 mA	

Monitoring the sensor lines for breakage

The sensor lines are monitored for breakage when the temperature is used for calculating the conductivity or concentration. If the sensor or line is broken, an alarm will be generated (output current FIX or 22 mA, depending on the configuration).

If you want to output a conductivity value that is independent of the measured temperature (uncompensated), you can monitor the sensor lines for breakage by setting "TEMP CHECK" to "ON" in the Alarm menu.

(See following page, ALARM menu)

Configuration		Choices	Default
Output 2 (OUT2)			
OT2:	CHANNEL	Cond/TMP	TMP
	... other steps like output 1		
Temperature compensation (CORRECTION)			
COR:	TC SELECT	OFF Compensation for ultrapure water: NaCl, HCL, NH3	OFF
	LIN	TC LIQUID	00.00 ... 19.99%/K
		REF TEMP	000.0 ... 199.9 °C
	TEMP EXT *)	ON/OFF	OFF
	ON	I-INPUT	0–20 mA / 4–20 mA
		°C	BEGIN 4 mA
			END 20 mA
		°F	BEGIN 4 mA
			END 20 mA
Control input (CNTR_IN)			
IN:	CONTROL	Parameter-set switchover (PARSET) or flow measurement (FLOW)	PARSET
	FLOW	FLOW ADJUST	0 ... 20000 pulses/liter
			12000 pulses/liter
Alarm (ALARM)			
ALA:	DELAYTIME	0 ... 600 SEC	0010 SEC
	SENSOCHECK	ON/OFF	OFF
	TEMP CHECK	ON/OFF	OFF
	FLOW CNTR *)	ON/OFF	OFF
	ON	FLOW MIN **)	0 ... 99.9 L/h
		FLOW MAX**)	0 ... 99.9 L/h
			005.0 L/h
			025.0 L/h

*) With TAN option SW-A005 and SENSOR "TEMP EXT" selected

***) These menu items appear only if selected.

****) Hysteresis fixed at 5 % of threshold value

Configuration

Configuration		Choices	Default
Parameter set (PARSET)			
PAR:	Select fixed parameter set (A) or switch between A/B via control input or manually in measuring mode	PARSET FIX / CNTR INPUT / MANUAL	PARSET FIX (fixed parameter set A)
Real-time clock (CLOCK)			
CLK:	FORMAT	24 h / 12 h	24 h
	24 h	TIME hh/mm	00..23:00...59
	12 h	TIME hh/mm	00 ... 12:59 AM / 01 ... 11:59 PM
	DAY/MONTH	01...31/01...12	
	YEAR	2000...2099	
Measuring points (TAG / GROUP)			
TAG:	(Input in text line)	A...Z, 0...9, - + < > ? / @	
GROUP:	(Input in text line)	0000...9999	0000
Display backlighting (DISPLAY)			
DSP:	BACKLIGHT	On, Off	On

Configuration (Template for Copy)

Two complete parameter sets are stored in the EEPROM.
As delivered, the two sets are identical but can be edited.

Note:

Fill in your configuration data on the following pages or use them as original for copy.

Configuration (Template for Copy)

Parameter	Parameter set A	Parameter set B
SNS: Sensor type		--- *)
SNS: Measuring mode		---
SNS: Measuring range		---
SNS: Concentration determination		---
SNS: Temperature unit		---
SNS: Temp detection		---
SNS: Manual temp		---
SNS: CIP counter		---
SNS: SIP counter		---
SNS: CHECK TAG		
SNS: CHECK GROUP		
OT1: Process variable		
OT1: Lin/bilin/log output		
OT1: Current start		
OT1: Current end		
OT1: Vertex X (bilinear curve only)		
OT1: Vertex Y (bilinear curve only)		
OT1: Filter time		
OT1: FAIL 22 mA (error messages)		
OT1: FACE 22 mA (Sensoface messages)		
OT1: HOLD mode		
OT1: HOLD FIX current		

Configuration (Template for Copy)

Parameter	Set A	Set B
OT2: Process variable		
OT2: Lin/bilin/log output		
OT2: Current start		
OT2: Current end		
OT2: Vertex X (bilinear curve only)		
OT2: Vertex Y (bilinear curve only)		
OT2: Filter time		
OT2: FAIL 22 mA (error messages)		
OT2: FACE 22 mA (Sensoface messages)		
OT2: HOLD mode		
OT2: HOLD FIX current		
COR: TC SELECT		
COR: Temp coefficient		
COR: Reference temperature		
COR: Current range (I input)		
COR: Current start (I input)		
COR: Current end (I input)		
IN: Parameter set A/B or flow		
IN: (Flow meter) Adjusting pulses/liter		
ALA: Delay		
ALA: Sensocheck on/off		
ALA: Tempcheck on/off		
ALA: Flow control FLOW CNTR on/off		
ALA: Minimum flow (hysteresis fixed at 5 %)		
ALA: Maximum flow (hysteresis fixed at 5 %)		
PAR: Parameter set selection		---*)
CLK: Time format		---
TAG: Measuring point (tag number)		
GROUP: Group of measuring points		
DISPLAY: Display backlighting		---

*) These parameters cannot be adjusted in parameter set B, the values are the same as in parameter set A.

Configuration

Sensor

Select: Sensor type, measuring mode, range

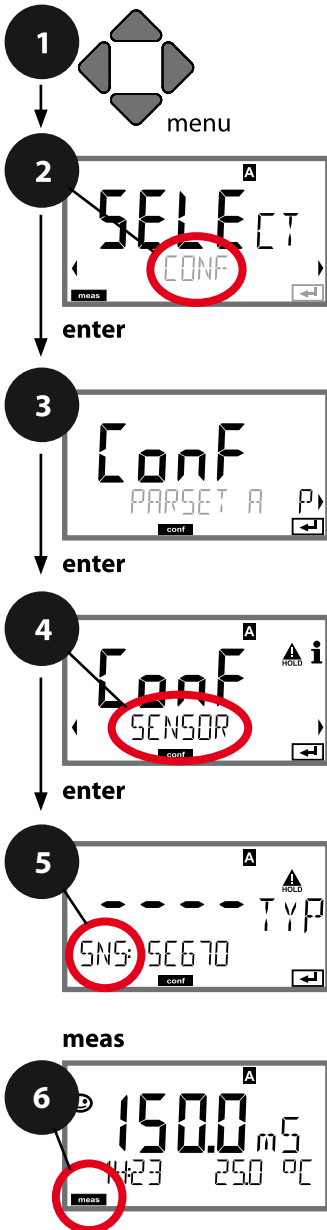

- 1) Press **menu** key.
- 2) Select **CONF** using ◀ ▶, press **enter**.
- 3) Select parameter set using ◀ ▶ keys, press **enter**.
- 4) Select **SENSOR** menu using ◀ ▶ keys, press **enter**.
- 5) All items of this menu group are indicated by the "SNS:" code. Press **enter** to select menu, edit using arrow keys (see next page). Confirm (and proceed) by pressing **enter**.
- 6) Exit: Press **meas** key until the [meas] mode indicator is displayed.

Sensor type	5
Measuring mode	
Measuring range	
Concentration determination	
Temperature unit	
Temperature detection	
Cleaning cycles	
Sterilization cycles	
CHECK TAG	
CHECK GROUP	

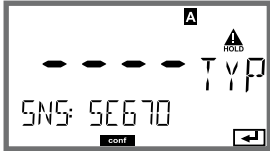
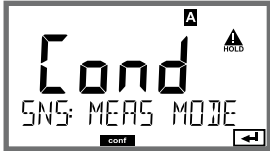
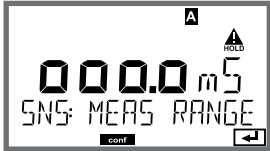
Menu item	Action	Choices
Sensor type 	Select sensor type using ▲ ▼ keys. Press enter to confirm.	MEMOSENS SE 680-M SE 670-K SE 670
Measuring mode 	Select desired measuring mode using ▲ ▼ keys. Press enter to confirm.	Cond Conc % Sal ‰
Measuring range 	For cond measurement only Select desired range using ▲ ▼ keys. Press enter to confirm.	xxx.x μS/cm x.xxx mS/cm , xx.xx mS/cm xxx.x mS/cm, x.xxx S/m xx.xx S/m

Configuration

Sensor

Select: Concentration determination

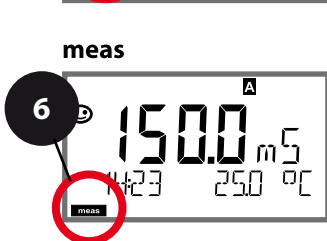
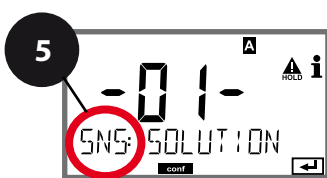
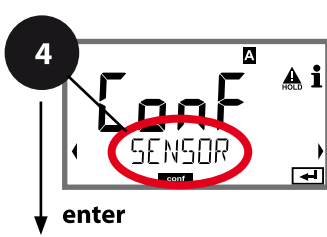
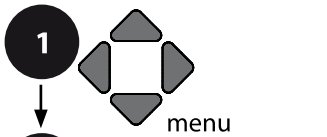

- 1) Press **menu** key.
- 2) Select **CONF** using ◀ ▶ keys, press **enter**.
- 3) Select parameter set using ◀ ▶, press **enter**.
- 4) Select **SENSOR** menu using ◀ ▶ keys, press **enter**.
- 5) All items of this menu group are indicated by the "SNS:" code.
Press **enter** to select menu, edit using arrow keys (see next page). Confirm (and proceed) using **enter**.
- 6) Exit: Press **meas** key until the [meas] mode indicator is displayed.

5

Sensor type	enter
Measuring mode	enter
Measuring range	enter
Concentration determination	
Temperature unit	
Temperature detection	
Cleaning cycles	
Sterilization cycles	
CHECK TAG	
CHECK GROUP	

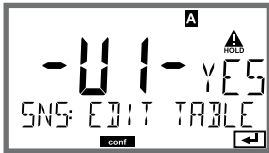
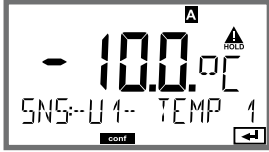
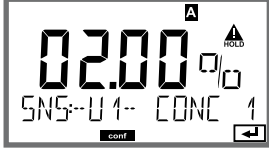
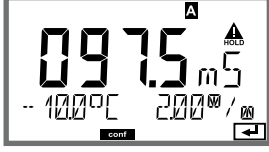
Menu item	Action	Choices
Concentration determination	<p>For conc measurement only</p> <p>Select desired concentration solution using ▲ ▼ .</p> <p>Press enter to confirm.</p>	<p>-01- (NaCl), -02- (HCl), -03- (NaOH), -04- (H₂SO₄), -05- (HNO₃), -06- (H₂SO₄), -07- (HCl), -08- (HNO₃), -09- (H₂SO₄), -10- (NaOH), -U1-</p>
<p>-U1-: Specifying a Concentration Solution for Conductivity Measurement</p> <p>To specify a custom solution, 5 concentration values are entered in a matrix together with 5 temperature values 1 ... 5. First enter the 5 temperature values, then the corresponding conductivity values for each of the concentrations 1 ... 5. These solutions are then available as "U1" in addition to the default standard solutions.</p>		
	<p>Press enter to confirm</p>	
	<p>Use the arrow keys ▲ ▼ ◀ ▶ to enter temperature values 1 ... 5.</p> <p>Press enter to confirm.</p>	<p>Input range: -50...250 °C / -58...482 °F</p>
	<p>Use the arrow keys ▲ ▼ ◀ ▶ to enter concentration value 1.</p> <p>Press enter to confirm.</p>	
	<p>For concentration value 1: Use the arrow keys ▲ ▼ ◀ ▶ to enter conductivity values for temperatures 1 ... 5.</p> <p>Press enter to confirm.</p>	

Configuration

Sensor

Select: Temperature unit, temperature detection

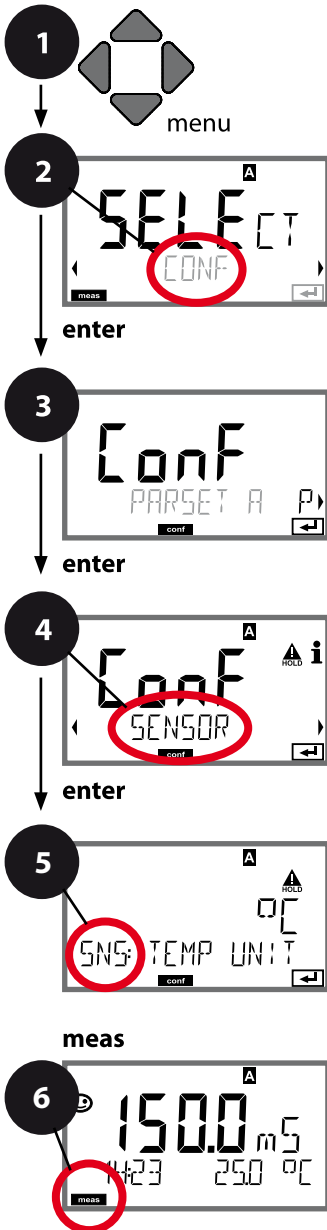

- 1) Press **menu** key.
- 2) Select **CONF** using ◀ ▶ keys, press **enter**.
- 3) Select parameter set using ◀ ▶, press **enter**.
- 4) Select **SENSOR** menu using ◀ ▶ keys, press **enter**.
- 5) All items of this menu group are indicated by the "SNS:" code.
Press **enter** to select menu, edit using arrow keys (see next page). Confirm (and proceed) using **enter**.
- 6) Exit: Press **meas** key until the [meas] mode indicator is displayed.

Sensor type
Measuring mode
Measuring range
Concentration determination
Temperature unit
Temperature detection
Cleaning cycles
Sterilization cycles
CHECK TAG
CHECK GROUP

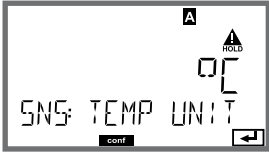
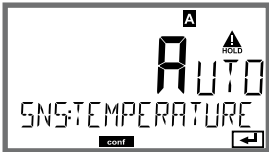
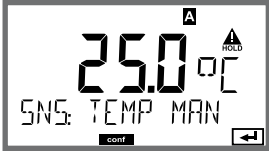
Menu item	Action	Choices
Temperature unit 	Select °C or °F using ▲ ▼ keys. Press enter to confirm.	°C / °F
Temperature detection 	Select mode using ▲ ▼ : AUTO: Measured by sensor MAN: Direct input of temperature, no measurement (see next step) EXT: Temperature specified via current input (only if TAN E enabled) Press enter to confirm.	AUTO MAN EXT
(Manual temperature) 	Modify digit using ▲ ▼ keys, select next digit using ◀ ▶ keys. Press enter to confirm.	-50...250 °C (-58...+482 °F)

Configuration

Sensor

Adjust: Cleaning cycles, sterilization cycles

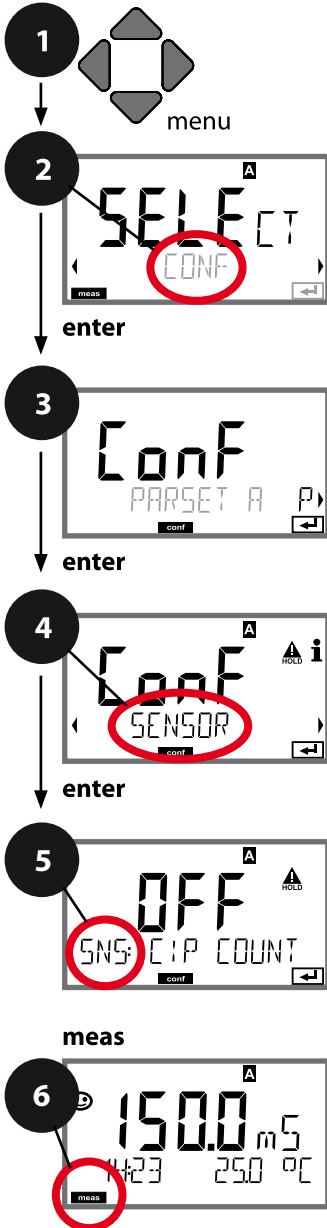

- 1) Press **menu** key.
- 2) Select **CONF** using ◀ ▶ keys, press **enter**.
- 3) Select parameter set using ◀ ▶, press **enter**.
- 4) Select **SENSOR** menu using ◀ ▶ keys, press **enter**.
- 5) All items of this menu group are indicated by the "SNS:" code.
Press **enter** to select menu, edit using arrow keys (see next page). Confirm (and proceed) using **enter**.
- 6) Exit: Press **meas** key until the [meas] mode indicator is displayed.

Sensor type	5	enter
Measuring mode		enter
Measuring range		enter
Concentration determination		
Temperature unit		
Temperature detection		
Cleaning cycles		
Sterilization cycles		
CHECK TAG		
CHECK GROUP		

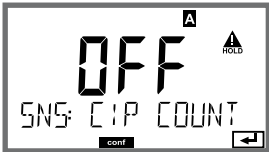
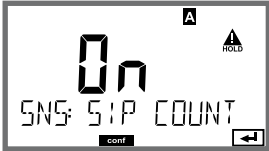
Menu item	Action	Choices
CIP / SIP		
Cleaning cycles 	Select ON or OFF using ▲ ▼ keys. Activates/deactivates logging in extended logbook (TAN SW-A003). Press enter to confirm.	ON/OFF
Sterilization cycles 	Select ON or OFF using ▲ ▼ keys. Activates/deactivates logging in extended logbook (TAN SW-A003). Press enter to confirm.	ON/OFF

Logging the cleaning and sterilization cycles with connected sensor helps measuring the load on the sensor.

Suitable for biochemical applications (process temp approx.

0 ... 50 °C / 32 ... 122 °F, CIP temp > 55 °C / 131 °F,

SIP temp > 115 °C / 239 °F).

Note:

A CIP or SIP cycle is only entered into the extended logbook (TAN SW-A003) 2 hours after the start to ensure that the cycle is complete. With Memosens (e.g., SE680-M), an entry is also made in the sensor.

Configuration

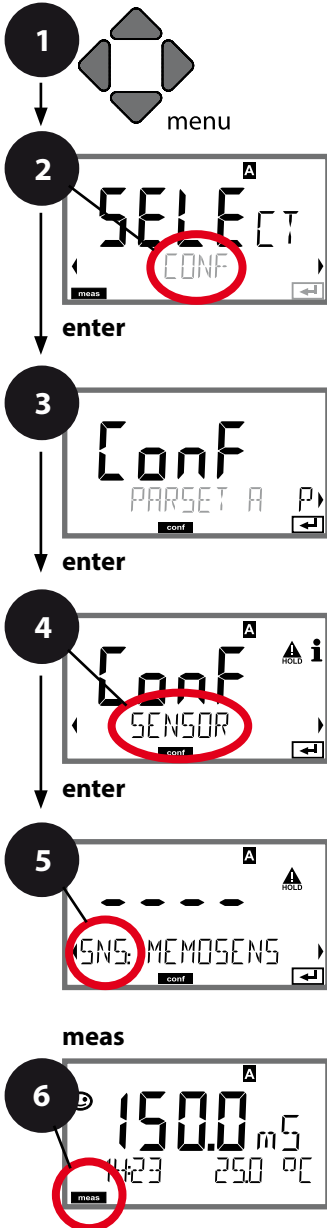

Memosens Sensor Sensor Verification (TAG, GROUP)



- 1) Press **menu** key.
- 2) Select **CONF** using ◀ ▶ keys, press **enter**.
- 3) Select parameter set using ◀ ▶, press **enter**.
- 4) Select **SENSOR** menu using ◀ ▶ keys, press **enter**.
- 5) All items of this menu group are indicated by the "SNS:" code.
Press **enter** to select menu, edit using arrow keys (see next page). Confirm (and proceed) using **enter**.
- 6) Exit: Press **meas** key until the [meas] mode indicator is displayed.

5

Sensor type	enter
Measuring mode	enter
Measuring range	enter
Concentration determination	
Temperature unit	
Temperature detection	
Cleaning cycles	
Sterilization cycles	
CHECK TAG	
CHECK GROUP	

Menu item	Action	Choices
<p>TAG</p> 	<p>Select ON or OFF using ▲ ▼ keys. Press enter to confirm.</p> <p>When switched on, the entry for "TAG" in the Memosens sensor is compared to the entry in the analyzer. If the entries differ, a message will be generated.</p>	<p>ON/OFF</p>
<p>GROUP</p> 	<p>Select ON or OFF using ▲ ▼ keys. Press enter to confirm.</p> <p>Function as described above</p>	<p>ON/OFF</p>

Sensor Verification (TAG, GROUP)

When Memosens sensors are calibrated in the lab, it is often useful and sometimes even mandatory that these sensors will be operated again at the same measuring points or at a defined group of measuring points. To ensure this, you can save the respective measuring point (TAG) or group of measuring points (GROUP) in the sensor. TAG and GROUP can be specified by the calibration tool or automatically entered by the transmitter. When connecting an MS sensor to the transmitter, it can be checked if the sensor contains the correct TAG or belongs to the correct GROUP. If not, a message will be generated, Sensoface gets "sad", and the display backlighting turns magenta (purple). The "sad" Sensoface icon can also be signaled by a 22 mA error current. Sensor verification can be switched on in the Configuration in two steps as TAG and GROUP if required.

When no measuring point or group of measuring points is saved in the sensor, e.g., when using a new sensor, Stratos enters its own TAG and GROUP. When sensor verification is switched off, Stratos always enters its own measuring point and group. A possibly existing TAG/GROUP will be overwritten.

Configuration

Current Output 1

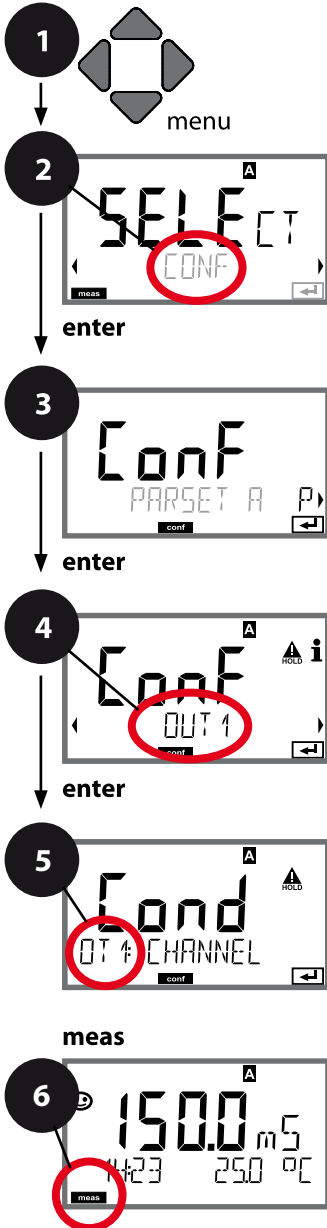

Output current range. Linear/Logarithmic. Current start.



- 1) Press **menu** key.
- 2) Select **CONF** using ◀ ▶ keys, press **enter**.
- 3) Select parameter set using ◀ ▶, press **enter**.
- 4) Select **OUT1** menu using ◀ ▶ keys, press **enter**.
- 5) All items of this menu group are indicated by the "OT1:" code.
Press **enter** to select menu, edit using arrow keys (see next page). Confirm (and proceed) using **enter**.
- 6) Exit: Press **meas** key until the [meas] mode indicator is displayed.

5

Process variable	enter
LIN/biLIN/LOG output	enter
Current start	
Current end	
Time averaging filter	
Output current during error message	
Output current during Sensoface messages	
Output current during HOLD	
Output current for HOLD FIX	

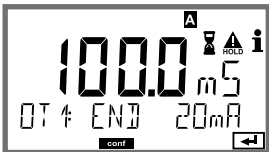
Menu item	Action	Remark
Process variable 	Select using \blacktriangle \blacktriangledown keys: Cond: Conductivity TMP: Temperature Press enter to confirm. Then select characteristic (LIN/biLIN/LOG).	Selectable decades with logarithmic setting (LOG): S/cm: 0.001 mS/cm, 0.01 mS/cm, 0.1 mS/cm, 1.0 mS/cm, 10.0 mS/ cm, 100.0 mS/cm, 1000 mS/cm S/M: 0.001 S/m, 0.01 S/m, 0.1 S/m, 1.0 S/m, 10.0 S/m, 100 S/m
Current start 	Modify digit using \blacktriangle \blacktriangledown keys, select next digit using \blacktriangleleft \blacktriangleright keys. Press enter to confirm.	Entered value applies to selected process variable/ range If the adjusted range is exceeded, the device automatically switches to the next higher range (Autorange)
Current end 	Enter value using \blacktriangle \blacktriangledown \blacktriangleleft \blacktriangleright keys. Press enter to confirm.	Entered value applies to selected process variable/ range If the adjusted range is exceeded, the device automatically switches to the next higher range (Autorange)

Assignment of measured values: Current start and current end

Example 1: Range 0...200 mS/cm

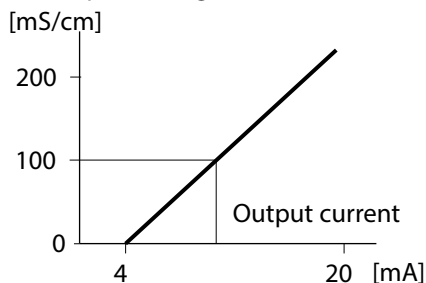

Example 2: Range 100...200 mS/cm

Advantage: Higher resolution in range
of interest

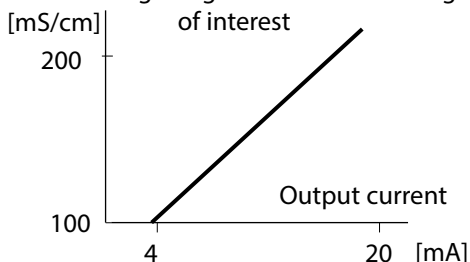

Configuration

Current Output 1

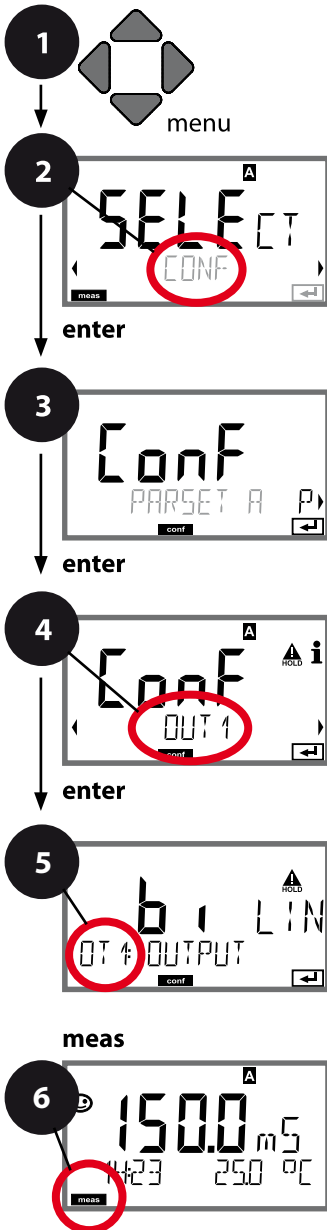

Output current curve, bilinear



- 1) Press **menu** key.
- 2) Select **CONF** using **◀ ▶** keys, press **enter**.
- 3) Select parameter set using **◀ ▶**, press **enter**.
- 4) Select **OUT1** menu using **◀ ▶** keys, press **enter**.
- 5) All items of this menu group are indicated by the "OT1:" code.
Press **enter** to select menu, edit using arrow keys (see next page). Confirm (and proceed) using **enter**.
- 6) Exit: Press **meas** key until the [meas] mode indicator is displayed.

5

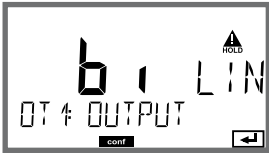
Process variable	enter
LIN/biLIN/LOG output	enter
Current start	
Current end	
Bilinear: Vertex X	
Bilinear: Vertex Y	
Time averaging filter	
Output current during error message	
Output current during HOLD	
Output current for HOLD FIX	

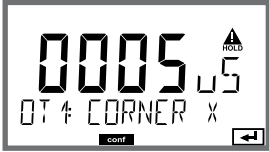
Menu item	Action	Choices
Output current curve 	Select using ▲ ▼ keys. Press enter to confirm.	LIN Linear characteristic biLIN Bilinear curve LOG Logarithmic curve
Current start and current end 	Enter value using ▲ ▼ ◀ ▶ keys. Press enter to confirm.	Entered value applies to selected process variable/range If the adjusted range is exceeded, the device automatically switches to the next higher range (Autorange)
Bilinear curve: Vertex X/Y 	Enter value using ▲ ▼ ◀ ▶ keys. Press enter to confirm.	Entered value applies to selected vertex of bilinear curve "Corner X" (process variable) and "Corner Y" (output current) – see figure below.

Vertex of bilinear curve

Output current

[mA]

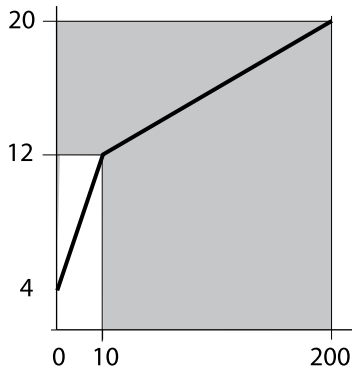

Example:

Current range 4 ... 20 mA,

Current start: 0 $\mu\text{S/cm}$

Current end: 200 $\mu\text{S/cm}$

Vertex:

"CORNER X": 10 $\mu\text{S/cm}$ (process variable)

"CORNER Y": 12 mA (output current)

Result: The output current change in the range 0 ... 10 $\mu\text{S/cm}$ is much greater than in the range 10 ... 200 $\mu\text{S/cm}$.

Process variable
[$\mu\text{S/cm}$]

Logarithmic Curve

Nonlinear output current characteristic: allows measurements over several decades, e.g. measuring very low values with a high resolution and high values with a low resolution.

Parameters required: Start and end value

Possible start and end values

The start value must be at least one decade lower than the end value.

Start value and end value must be specified in the same units (either in $\mu\text{S}/\text{cm}$ or in S/m , see listing):

0.001 mS/cm	0.001 S/m
0.01 mS/cm	0.01 S/m
0.1 mS/cm	0.1 S/m
	1.0 S/m
	10.0 S/m
	100 S/m

The start value

is the next decade value below the lowest measured value.

The end value

is the next decade value above the highest measured value.

The number of decades results from:

$$\text{Number of decades} = \log(\text{end value}) - \log(\text{start value})$$

The output current value is defined as follows:

$$\text{Output current} = 16 \text{ mA} * \frac{\log(\text{measured value}) - \log(\text{start value})}{\text{Number of decades}} + 4 \text{ mA}$$

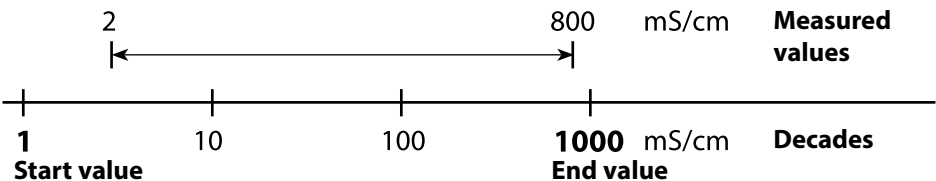

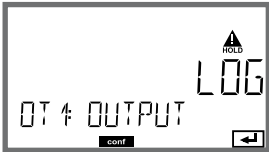
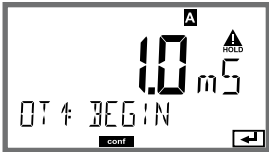
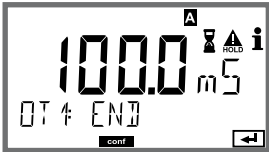
Menu item	Action	Choices
Logarithmic curve of output current 	Select using ▲ ▼ keys. Press enter to confirm.	LOG Logarithmic curve biLIN Bilinear curve LIN Linear characteristic
Start value 	Enter value using ▲ ▼ ◀ ▶ keys. Press enter to confirm.	Start value of logarithmic output curve
End value 	Enter value using ▲ ▼ ◀ ▶ keys. Press enter to confirm.	End value of logarithmic output curve

Possible start and end values for the logarithmic curve

S/cm:

0.001 mS/cm, 0.01 mS/cm, 0.1 mS/cm

S/m:

0.001 S/m, 0.01 S/m, 0.1 S/m, 1.0 S/m, 10.0 S/m, 100 S/m

Configuration

Current Output 1

Adjusting the time interval of the output filter

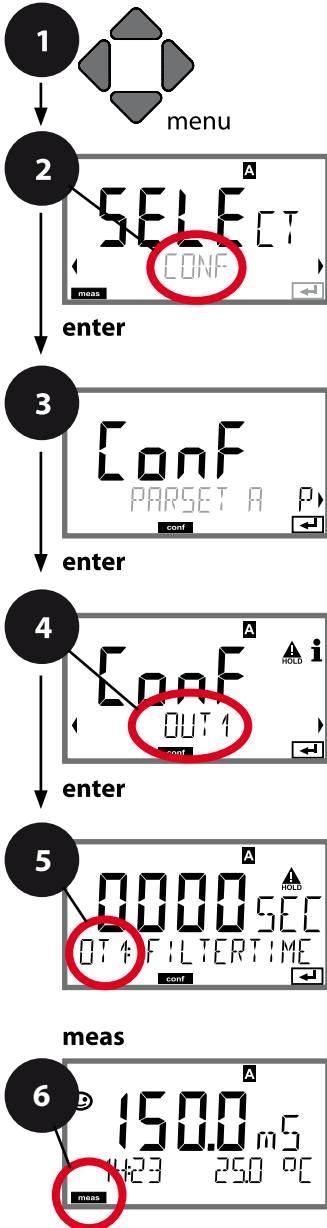

- 1) Press **menu** key.
- 2) Select **CONF** using **◀ ▶** keys, press **enter**.
- 3) Select parameter set using **◀ ▶**, press **enter**.
- 4) Select **OUT1** menu using **◀ ▶** keys, press **enter**.
- 5) All items of this menu group are indicated by the "OT1:" code.
Press **enter** to select menu, edit using arrow keys (see next page). Confirm (and proceed) using **enter**.
- 6) Exit: Press **meas** key until the [meas] mode indicator is displayed.

5

Process variable	enter
LIN/biLIN/LOG output	enter
Current start	
Current end	
Time averaging filter	
Output current during error message	
Output current during Sensoface messages	
Output current during HOLD	
Output current for HOLD FIX	

Menu item	Action	Choices
Time averaging filter	Enter value using ▲ ▼ ◀ ▶ keys. Press enter to confirm.	0...120 SEC (0000 SEC)

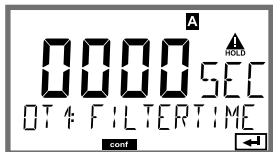

Time averaging filter

To smoothen the current output, a low-pass filter with adjustable filter time constant can be switched on. When there is a jump at the input (100 %), the output level is at 63 % after the time interval has been reached. The time interval can be set from 0 to 120 sec. If the time interval is set to 0 sec, the current output directly follows the input.

Note:

The filter only acts on the current output, not on the display or the limit value!

During HOLD the filter is not applied. This prevents a jump at the output.

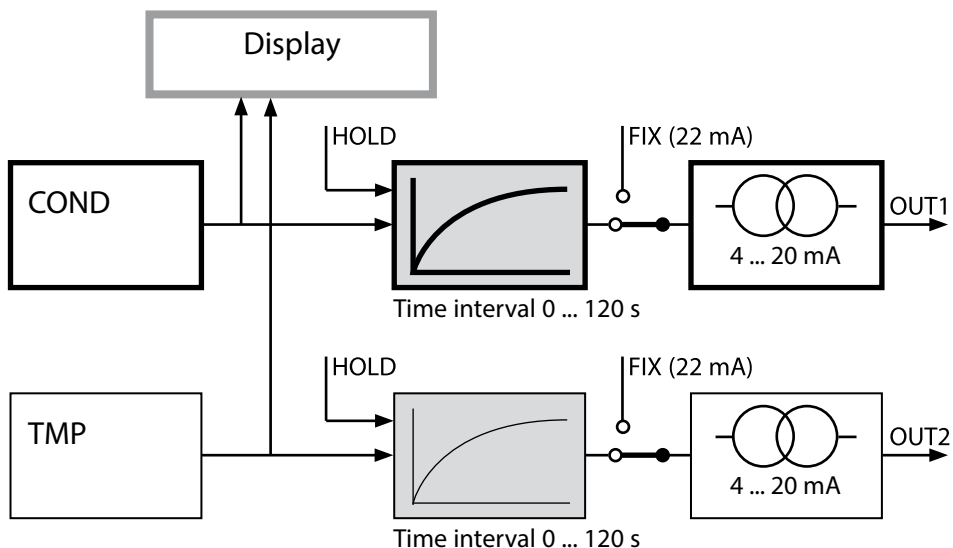

Configuration

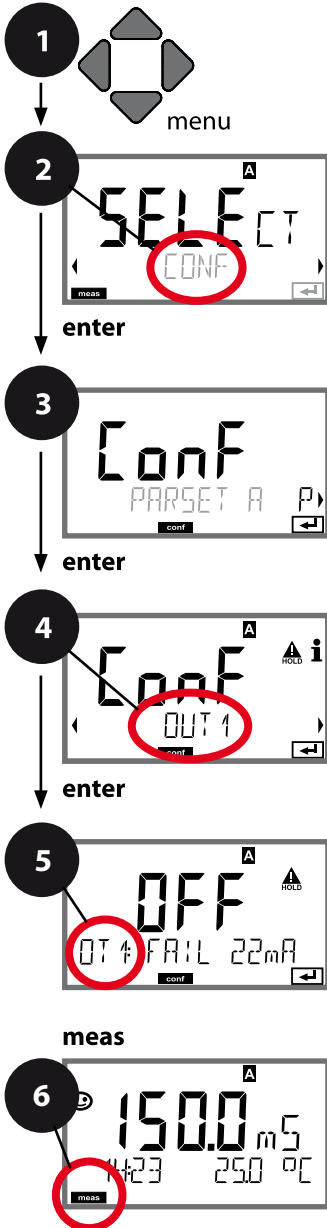

Current Output 1

Output current during Error and HOLD

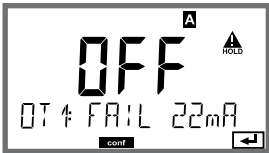
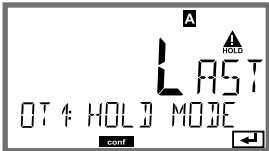

- 1) Press **menu** key.
- 2) Select **CONF** using **◀ ▶** keys, press **enter**.
- 3) Select parameter set using **◀ ▶**, press **enter**.
- 4) Select **OUT1** menu using **◀ ▶** keys, press **enter**.
- 5) All items of this menu group are indicated by the "OT1:" code.
Press **enter** to select menu, edit using arrow keys (see next page). Confirm (and proceed) using **enter**.
- 6) Exit: Press **meas** key until the [meas] mode indicator is displayed.

Process variable	enter
LIN/biLIN/LOG output	enter
Current start	enter
Current end	
Time averaging filter	
Output current during error message	
Output current during Sensoface messages	
Output current during HOLD	
Output current for HOLD FIX	

Menu item	Action	Choices
Output current during error message 	Select ON (22 mA for error message) or OFF using \blacktriangle \blacktriangledown keys. Press enter to confirm.	ON/OFF
Output current during Sensoface messages OT1: FACE 22 mA	Select ON or OFF using \blacktriangle \blacktriangledown keys. Confirm by pressing enter	ON/OFF
Output current during HOLD 	LAST: During HOLD the last measured value is maintained at the output. FIX: During HOLD a value (to be entered) is maintained at the output. Select using \blacktriangle \blacktriangledown . Press enter to confirm.	LAST/FIX
Output current for HOLD FIX 	Only with FIX selected: Enter current which is to flow at the output during HOLD. Enter value using \blacktriangle \blacktriangledown \blacktriangleleft \blacktriangleright keys. Press enter to confirm.	04.00...22.00 mA (21.00 mA)

Output signal during HOLD:

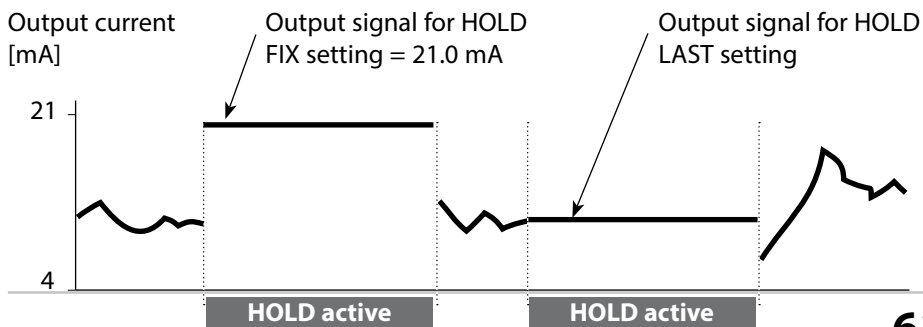

Configuration

Current Output 2

Output current range. Process variable . . .

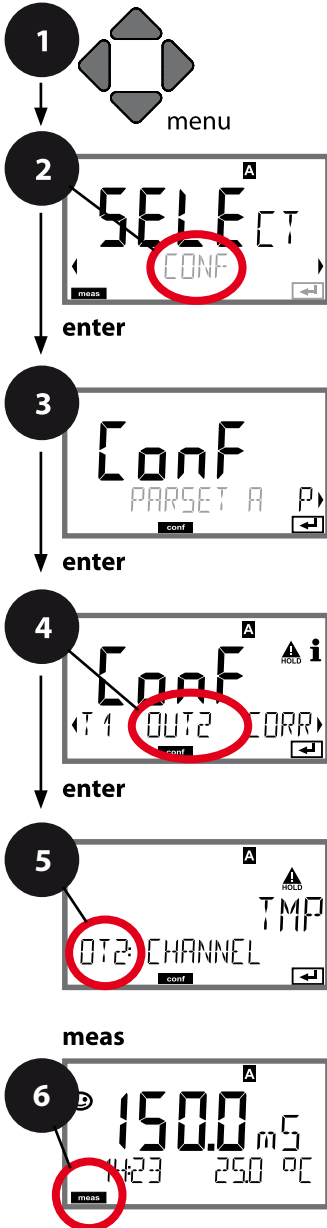

- 1) Press **menu** key.
- 2) Select **CONF** using **◀ ▶** keys, press **enter**.
- 3) Select parameter set using **◀ ▶**, press **enter**.
- 4) Select **OUT2** menu using **◀ ▶** keys, press **enter**.
- 5) All items of this menu group are indicated by the "OT2:" code.
Press **enter** to select menu, edit using arrow keys (see next page). Confirm (and proceed) using **enter**.
- 6) Exit: Press **meas** key until the [meas] mode indicator is displayed.

Process variable	enter
LIN/biLIN/LOG output	↻
Current start	↻
Current end	
Time averaging filter	
Output current during error message	
Output current during Sensoface messages	
Output current during HOLD	
Output current for HOLD FIX	

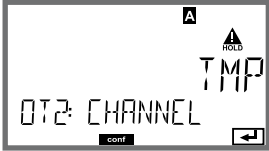
Menu item	Action	Choices
Process variable 	Select using ▲ ▼ keys: Cond: Conductivity TMP: Temperature Press enter to confirm.	Cond/ TMP Begin: 0 °C End: 100°C
<ul style="list-style-type: none"> • • • 		

All the following adjustments are made as for current output 1 (see there)!

Configuration

Temperature Compensation

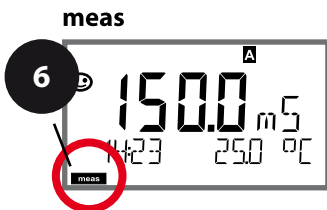
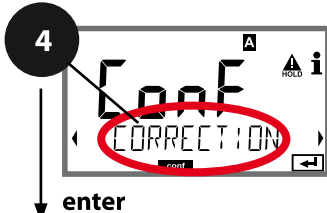
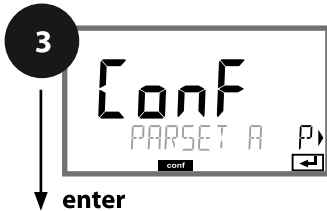
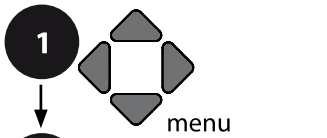

Selecting the compensation method. TC process medium.



- 1) Press **menu** key.
- 2) Select **CONF** using ◀ ▶ keys, press **enter**.
- 3) Select parameter set using ◀ ▶, press **enter**.
- 4) Select **CORRECTION** menu using ◀ ▶ keys, press **enter**.
- 5) All items of this menu group are indicated by the "COR:" code.
Press **enter** to select menu, edit using arrow keys (see next page). Confirm (and proceed) using **enter**.
- 6) Exit: Press **meas** key until the [meas] mode indicator is displayed.

5

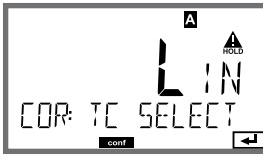
Temperature compensation	enter
Temperature compensation of process medium	
Enter reference temperature	
Current input, external temp measurement	
Current start	
Current end	

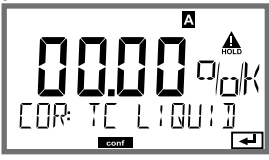
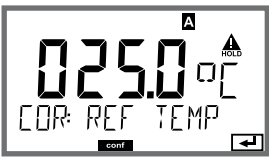
Menu item	Action	Choices
Temperature compensation	<p>Select desired compensation using \blacktriangle \blacktriangledown keys:</p> <p>OFF: Temp compensation</p> <p>LIN: Linear temperature compensation with entry of temperature coefficient</p> <p>nLF: Temperature compensation for natural waters to EN 27888</p> <p>NaCl: Ultrapure water with NaCl traces (0 ... +120 °C / +32 ... +248 °F)</p> <p>HCl: Ultrapure water with HCl traces (0 ... +120 °C / +32 ... +248 °F)</p> <p>NH3: Ultrapure water with NH₃ traces (0 ... +120 °C / +32 ... +248 °F)</p> <p>NaOH: Ultrapure water with NaOH traces (0 ... +120 °C / +32 ... +248 °F)</p> <p>Press enter to confirm.</p>	  
Temperature compensation of process medium  Enter reference temperature 	<p>With linear compensation only:</p> <p>Step 1: Enter temperature compensation of the process medium.</p> <p>Step 2: Enter reference temperature. Enter value using \blacktriangle \blacktriangledown \blacktriangleleft \blacktriangleright keys. Press enter to confirm.</p> <p>Permissible range 0 ... 199.9 °C</p>	00.00...19.99 %/K

Configuration

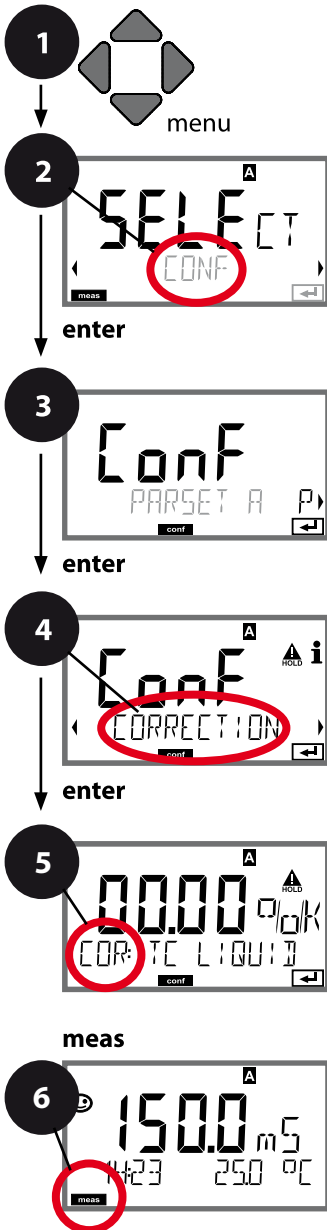

Temperature Compensation

Current input for temp measurement.

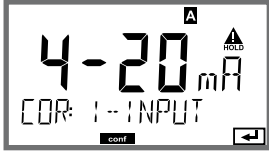

- 1) Press **menu** key.
- 2) Select **CONF** using ◀ ▶ keys, press **enter**.
- 3) Select parameter set using ◀ ▶, press **enter**.
- 4) Select **CORRECTION** menu using ◀ ▶ keys, press **enter**.
- 5) All items of this menu group are indicated by the "COR:" code.
Press **enter** to select menu, edit using arrow keys (see next page). Confirm (and proceed) using **enter**.
- 6) Exit: Press **meas** key until the [meas] mode indicator is displayed.

Temperature compensation	5	enter
Temperature compensation of process medium		
Enter reference temperature		
Current input, external temp measurement (if enabled via TAN)		
Current start		
Current end		

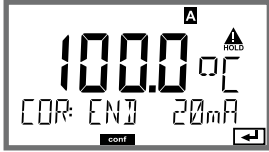
Menu item	Action	Choices
With external temp measurement (current input enabled / TAN):		
Current range	Select desired range using ▲ ▼ keys. Press enter to confirm.	4-20 mA / 0-20 mA
		
Current start	Modify digit using ▲ ▼ keys, select next digit using ◀ ▶ keys. Press enter to confirm.	Input range: -50...250 °C / -58...482 °F
		
Current end	Enter value using ▲ ▼ ◀ ▶ keys. Press enter to confirm.	Input range: -50...250 °C / -58...482 °F
		

Configuration

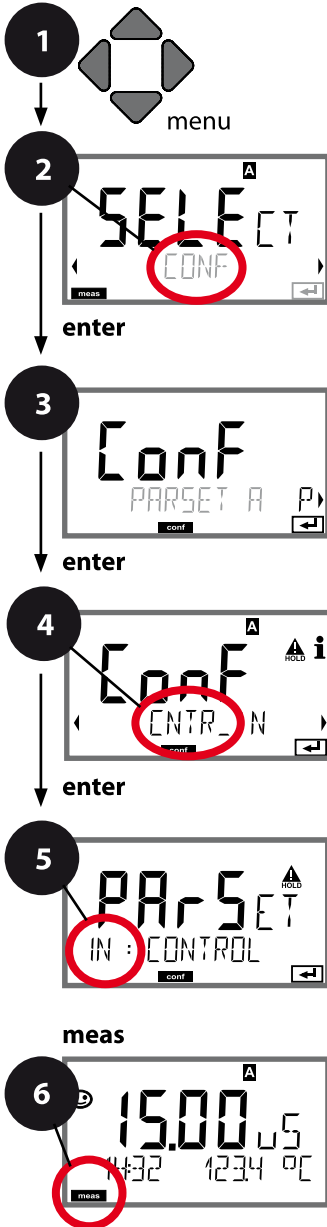

CONTROL Input (TAN SW-A005)

Parameter set selection via external signal or flow measurement

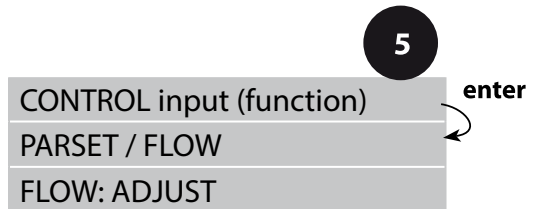

- 1) Press **menu** key.
- 2) Select **CONF** using ◀ ▶ keys, press **enter**.
- 3) Select parameter set using ◀ ▶, press **enter**.
- 4) Select **CNTR_IN** menu using ◀ ▶ keys, press **enter**.
- 5) All items of this menu group are indicated by the "IN:" code.
Press **enter** to select menu, edit using arrow keys (see next page). Confirm (and proceed) using **enter**.
- 6) Exit: Press **meas** key until the [meas] mode indicator is displayed.



Menu item	Action	Choices
Select function of CONTROL input 	Select using ▲ ▼ keys. Press enter to confirm.	PARSET (selecting parameter set A/B via signal at CONTROL input)
		Flow (for connecting a pulse-output flow meter)
Adjust to flow meter: 	With "Flow" selected, you must adjust the device to the flow meter used. Enter value using arrow keys. Press enter to confirm.	12000 pulses/liter

In the alarm menu you can configure flow monitoring. When you have set CONTROL to FLOW, you can specify 2 additional limit values for maximum and minimum flow.

If the measured value lies outside this range, an alarm message and a 22-mA error signal (if configured) will be generated.

Display

Flow measurement in measuring mode



Display

Flow measurement (sensor monitor)



Configuration

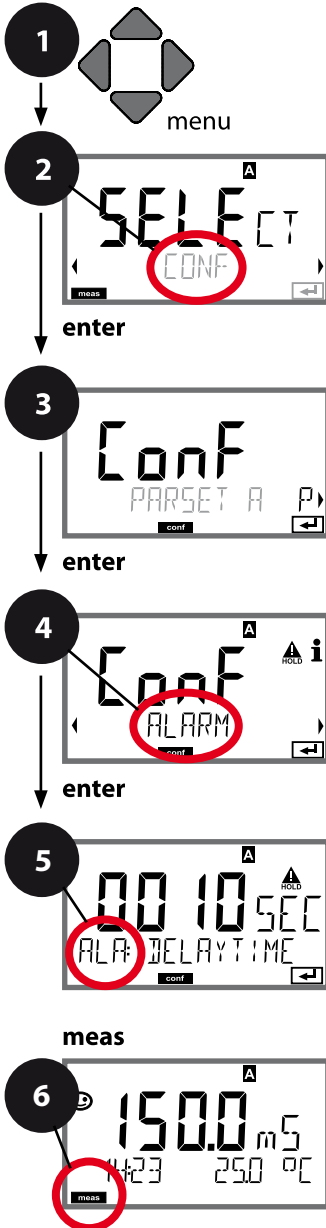

Alarm Settings

Delay. Sensocheck. Tempcheck.

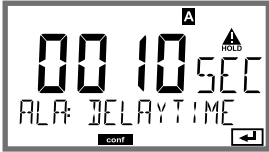

- 1) Press **menu** key.
- 2) Select **CONF** using ◀ ▶ keys, press **enter**.
- 3) Select parameter set using ◀ ▶, press **enter**.
- 4) Select **ALARM** menu using ◀ ▶ keys, press **enter**.
- 5) All items of this menu group are indicated by the "ALA:" code.
Press **enter** to select menu, edit using arrow keys (see next page). Confirm (and proceed) using **enter**.
- 6) Exit: Press **meas** key until the [meas] mode indicator is displayed.

Delay
Sensocheck
Tempcheck
CONTROL input
For flow monitoring: Max. flow alarm
For flow monitoring: Min. flow alarm

Menu item	Action	Choices
Delay 	Enter value using ▲ ▼ ◀ ▶ keys. Press enter to confirm.	0...600 SEC (010 SEC)
Sensocheck 	Select Sensocheck (continuous monitoring of sensor). Select ON or OFF using ▲ ▼ keys. Press enter to confirm (At the same time, Sensoface is activated. With OFF, Sensoface is also switched off.)	ON/OFF
Tempcheck (see page 36)	To monitor the tempera- ture probe with TC OFF selected: Select Tempcheck ON using ▲ ▼ keys. Press enter to confirm. Now, the temperature probe will be monitored.	ON/OFF

Error messages can be signaled by a 22 mA output current (see Error Messages and Configuration of Output 1/Output 2).

The alarm delay time delays the color change of the display back-lighting to red and the 22 mA signal (if configured).

Configuration

Alarm Settings

CONTROL input (TAN SW-A005)

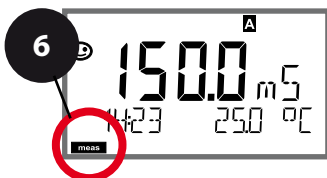
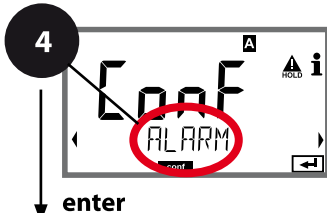
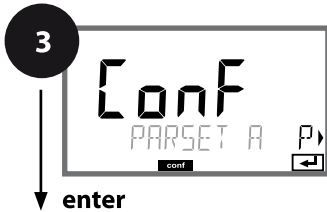
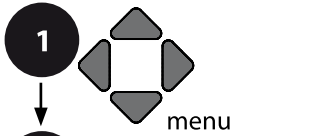

- 1) Press **menu** key.
- 2) Select **CONF** using ◀ ▶ keys, press **enter**.
- 3) Select parameter set using ◀ ▶, press **enter**.
- 4) Select **ALARM** menu using ◀ ▶ keys, press **enter**.
- 5) All items of this menu group are indicated by the "ALA:" code.
Press **enter** to select menu, edit using arrow keys (see next page). Confirm (and proceed) using **enter**.
- 6) Exit: Press **meas** key until the [meas] mode indicator is displayed.

5

Delay	enter
Sensocheck	
Tempcheck	
CONTROL input	
For flow monitoring: Max. flow alarm	
For flow monitoring: Min. flow alarm	

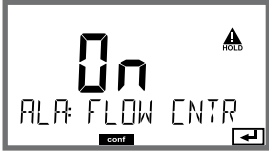
Menu item	Action	Choices
CONTROL input 	The CONTROL input can generate an alarm when assigned to FLOW (flow monitoring) in the CONF menu: FLOW CNTR Flow measurement: allows monitoring the minimum and maximum flow (pulse counter)	ON/OFF (FLOW MIN, FLOW MAX.)
Alarm Minimum flow FLOW MIN	Specify value	Default: 05.00 liters/h
Alarm Maximum flow FLOW MIN	Specify value	Default: 25.00 liters/h

Configuration

Time and Date

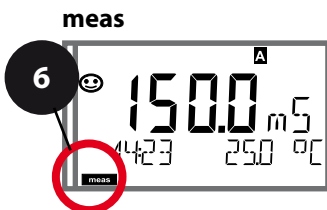
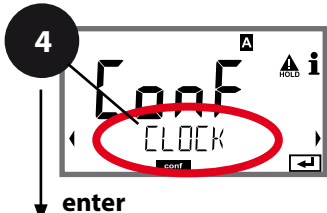
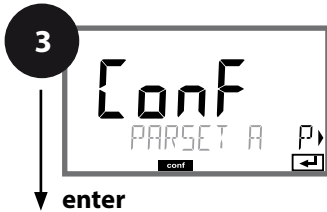
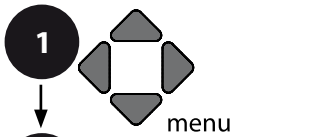

- 1) Press **menu** key.
- 2) Select **CONF** using ◀ ▶, press **enter**.
- 3) Select parameter set A using ◀ ▶ keys, press **enter**.
- 4) Select **CLOCK** using ◀ ▶ keys, press **enter**.
- 5) All items of this menu group are indicated by the "CLK:" code.
Press **enter** to select menu, edit using arrow keys (see next page). Confirm (and proceed) by pressing **enter**.
- 6) Exit: Press **meas** key until the [meas] mode indicator is displayed.

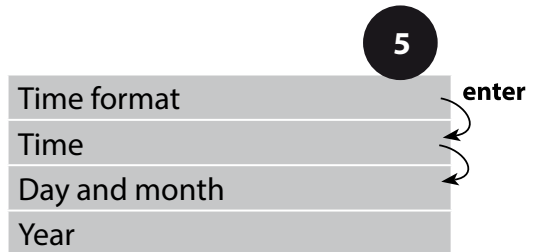

Time and Date

Control of the calibration and cleaning cycles is based on the time and date of the integrated real-time clock.

In measuring mode the time is shown in the lower display. When using digital sensors, the calibration data is written in the sensor head. In addition, the logbook entries (cf Diagnostics) are provided with a time stamp.

Note:

There is no automatic switchover from winter to summer time!

Be sure to manually adjust the time!

Configuration

Measuring Points (TAG/GROUP) Display Backlighting

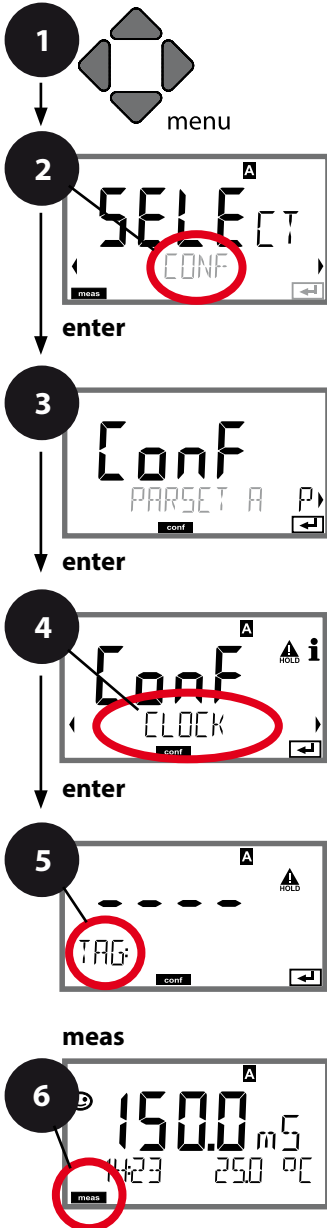

- 1) Press **menu** key.
- 2) Select **CONF** using ◀ ▶, press **enter**.
- 3) Select parameter set A using ◀ ▶ keys, press **enter**.
- 4) Select **TAG** or **DISPLAY** using ◀ ▶ keys, press **enter**.
- 5) All items of this menu group are indicated by the "TAG:" or "DSP" code. Press **enter** to select menu, edit using arrow keys (see next page). Confirm (and proceed) by pressing **enter**.
- 6) Exit: Press **meas** key until the [meas] mode indicator is displayed.

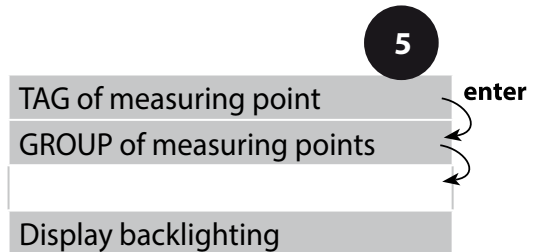

Sensor Verification (TAG, GROUP)

When Memosens sensors are calibrated in the lab, it is often useful and sometimes even mandatory that these sensors will be operated again at the same measuring points or at a defined group of measuring points. To ensure this, you can save the respective measuring point (TAG) or group of measuring points (GROUP) in the sensor. TAG and GROUP can be specified by the calibration tool or automatically entered by the transmitter. When connecting an MS sensor to the transmitter, it can be checked if the sensor contains the correct TAG or belongs to the correct GROUP. If not, a message will be generated, Sensoface gets “sad”, and the display backlighting turns purple (magenta). The “sad” Sensoface icon can also be signaled by a 22 mA error current. Sensor verification can be switched on in the Configuration in two steps as TAG and GROUP if required.

When no measuring point or group of measuring points is saved in the sensor, e.g., when using a new sensor, Stratos enters its own TAG and GROUP. When sensor verification is switched off, Stratos always enters its own measuring point and group. A possibly existing TAG/GROUP will be overwritten.

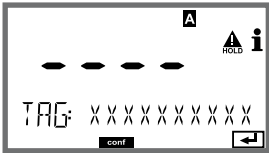
Menu item	Action	Choices
<p>Measuring point (TAG)</p> 	<p>In the lower display line you can enter a designation for the measuring point (TAG) and for a group of measuring points (GROUP) if applicable. Up to 32 digits are possible. Select character using ▲ ▼ keys, select next digit using ◀ ▶ keys. Press enter to confirm. By pressing meas (repeatedly) in the measuring mode you can view the tag number.</p>	<p>A...Z, 0...9, – + < > ? / @</p> <p>The first 10 characters are seen in the display without scrolling.</p>

Switch Off the Display Backlighting

The display backlighting can be switched off in the DISPLAY menu.

Note: If the display backlighting is off, color signaling of error events is not possible.

Note:

- All calibration procedures must be performed by trained personnel. Incorrectly set parameters may go unnoticed, but change the measuring properties.

Calibration can be performed by:

- Determining the cell factor with a known calibration solution taking account of the temperature
- Input of cell factor (e.g. for ultrapure-water sensors)
- Entering an installation factor
- Sampling (product calibration)
- Zero calibration in air
- Temperature probe adjustment

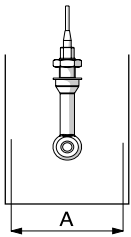
**Note:**

If measurements are performed in fittings with $A < 110$ mm, be sure to choose a calibration beaker with the same cross-section and of the same material (metal/plastic)!

Selecting a Calibration Mode

Calibration adapts the device to the individual sensor characteristics. Access to calibration can be protected with a passcode (SERVICE menu).

First, you open the calibration menu and select the calibration mode:

CAL_SOL	Calibration with calibration solution
CAL_CELL	Calibration by entry of cell factor
CAL_INSTALL	Calibration by entry of an installation factor
P_CAL	Product calibration (calibration with sampling)
CAL_ZERO	Zero calibration
CAL_RTD	Temperature probe adjustment

Calibration



Calibration with Calibration Solution



Input of temperature-corrected value of calibration solution with simultaneous display of cell factor.

Be sure to use known calibration solutions and the respective temperature-corrected conductivity values (see calibration solution tables in the appendix). During the calibration procedure the temperature must be kept constant.

Note:





When using an ARF 210/215 flow-through fitting, you should use the included calibration beakers (identical dimensions and materials) for calibration to prevent calibration errors.

Display	Action	Remark
	Select Calibration. Press enter to proceed. Select CAL_SOL calibration method. Press enter to proceed.	
	Ready for calibration. Hourglass blinks.	Display (3 sec) Now the device is in HOLD mode.
	Immerse sensor in calibration solution. Enter the temperature- corrected value of the calibration solution us- ing the arrow keys (see table in the appendix). Press enter to confirm.	Lower line: display of cell factor and temperature

Display	Action	Remark
	<p>The cell factor and zero point are displayed. The “hourglass” icon is blinking.</p>	
	<p>Use the arrow keys to select:</p> <ul style="list-style-type: none"> • Repeat (repeat calibration) or • Measuring. <p>Press enter to confirm.</p>	
	<p>With MEAS selected: End calibration by pressing enter.</p>	<p>Display of measured variable, Sensoface is active. After end of calibration, the outputs remain in HOLD mode for a short time. After display of GOOD BYE, the device automatically returns to measuring mode.</p>

Calibration by Input of Cell Factor

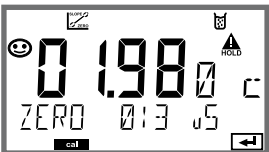



You can directly enter the value for the cell factor of a sensor. This value must be known, e.g. determined beforehand in the laboratory. The selected process variable and the temperature are displayed. This method is suitable for all process variables.

Display	Action	Remark
	Select Calibration. Press enter to proceed. Select CAL_CELL calibration method. Press enter to proceed.	
	Ready for calibration. Hourglass blinks.	Display (3 sec) Now the device is in HOLD mode.
	Enter cell factor. Press enter to proceed.	The selected process variable and the temperature are displayed.
	The device shows the calculated cell factor and zero point (at 25 °C). Sensoface is active.	
	Use the arrow keys to select: • MEAS (exit) • REPEAT Press enter to proceed.	Exit: HOLD is deactivated after a short time.

Please refer to the sensor specifications for the nominal cell factor. When measuring in a restricted space, the individual cell factor must be determined.

Calibration by Input of an Installation Factor

When using a Memosens sensor in a tight space, the installation factor is entered.

Display	Action	Remark
	<p>Select Calibration. Press enter to proceed. Select CAL_INSTALL calibration method. Press enter to proceed.</p>	
	<p>Ready for calibration. Hourglass blinks.</p>	<p>Display (3 sec) Now the device is in HOLD mode.</p>
	<p>Enter installation factor. Press enter to proceed.</p>	<p>The selected process variable and the temperature are displayed.</p>
	<p>Use the arrow keys to select:</p> <ul style="list-style-type: none"> • MEAS (end) • REPEAT <p>Press enter to proceed.</p>	<p>End: HOLD is deactivated after a short time.</p>

Calibration



Product Calibration





(Calibration by sampling)

For product calibration, the uncompensated conductivity (mS/cm, S/m) is used. During product calibration the sensor remains in the process. The measurement process is only interrupted briefly.

Procedure:



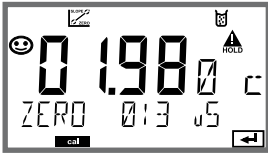

- 1) The sample is measured in the lab or directly on the site using a portable meter. To ensure an exact calibration, sample temperature and process temperature should be the same.
During sampling the device saves the currently measured value and then returns to measuring mode. Then, the "calibration" mode indicator blinks.
- 2) In the second step you enter the measured sample value in the device. From the difference between the stored measured value and entered sample value, the device calculates the new cell factor.
If the sample is invalid, you can take over the value stored during sampling. In that case the old calibration values are stored.
Afterwards, you can start a new product calibration.

Display	Action	Remark
	Select Calibration. Press enter to proceed. Select P_CAL calibration method. Press enter to proceed.	
	Ready for calibration. Hourglass blinks.	Display (3 sec) Now the device is in HOLD mode.
	Take sample and save value. Press enter to proceed.	Now the sample can be measured in the lab.



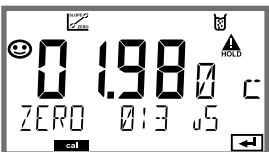

Display	Action	Remark
	The device returns to measuring mode.	From the blinking CAL mode indicator you see that product calibration has not been terminated.
	Product calibration step 2: When the sample value has been determined, open the product calibration once more	Display (3 sec) Now the device is in HOLD mode.
	The stored value is displayed (blinking) and can be overwritten with the lab value. Press enter to proceed.	
	Display of new cell factor and zero point (based on 25°C). Sensoface is active. Press enter .	To repeat calibration: Select REPEAT, then enter
	To end calibration: Select MEAS, then enter	
	After calibration is ended, the device will switch to measuring mode.	After end of calibration, the outputs remain in HOLD mode for a short time.

Calibration

Zero Calibration in Air

Display	Action	Remark
	Select Calibration. Press enter to proceed. Select CAL_ZERO calibration method. Press enter to proceed.	
	Ready for calibration. Hourglass blinks.	Display (3 sec) Now the device is in HOLD mode.
	Calibration in air Edit digits until the lower display indicates Zero Calibration in air (AIR-SET) for SE 680-M and Memosens sensors: Press enter to start AIR-SET. When zero point and cell factor are displayed, press enter to confirm.	SE 670, SE 680-K only Memosens: AIR SET
	The device shows the cell factor (at 25 °C) and the zero point. Sensoface is active.	
	Use the arrow keys to select: <ul style="list-style-type: none"> • MEAS (exit) • REPEAT Press enter to proceed.	Exit: HOLD is deactivated after a short time.

Temp Probe Adjustment

Display	Action	Remark
	<p>Select Calibration. Press enter to proceed. Select CAL_RTD calibration method. Press enter to proceed.</p>	<p>Wrong settings change the measurement properties!</p>
	<p>Measure the tempera- ture of the process medium using an external thermometer.</p>	<p>Display (3 sec) Now the device is in HOLD mode.</p>
	<p>Enter the measured temperature value. Maximum difference: 10 K. Press enter to proceed.</p>	<p>Display of actual temperature (un- compensated) in the lower display.</p>
	<p>The corrected tempera- ture value is displayed. Sensoface is active. To end calibration: Select MEAS, then enter To repeat calibration: Select REPEAT, then enter</p>	<p>After end of calibra- tion, the outputs re- main in HOLD mode for a short time.</p>
	<p>After calibration is ended, the device will switch to measuring mode.</p>	

Measurement

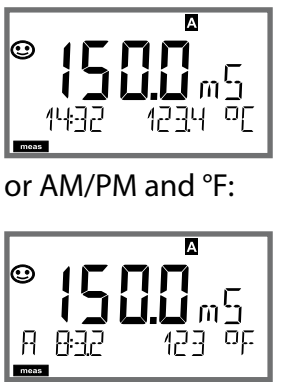
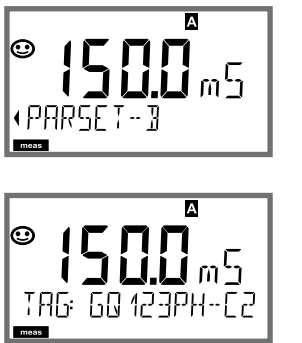
Display	Remark
 <p>or AM/PM and °F:</p>	<p>From the configuration or calibration menus, you can switch the device to measuring mode by pressing the meas key. In the measuring mode the upper display line shows the configured process variable (Cond or temperature), the lower display line shows the time and the second configured process variable (Cond or temperature). The [meas] mode indicator lights and the active parameter set (A/B) is indicated. A/B is not displayed with parameter set "Fix A".</p>
<p>By pressing the meas key you can step through the following displays. When no key has been pressed for 60 sec, the device returns to the standard display.</p>	
	<p>1) Selecting the parameter set (if set to "manual" in the configuration). Select the desired parameter set using the ◀ ▶ arrow keys (PARSET A or PARSET B blinks in the lower display line). Press enter to confirm.</p> <p>Further displays (each with meas).</p>
	<p>2) Display of measuring point ("TAG") 3) Display of time and date 4) Display of output current(s)</p>

Diagnostics

In the Diagnostics mode you can access the following menus without interrupting the measurement:

CALDATA	viewing the calibration data
SENSOR	viewing the sensor data
SELFTEST	starting a device self-test
LOGBOOK	viewing the logbook entries
MONITOR	displaying currently measured values
VERSION	displaying device type, software version, serial number



Access to diagnostics can be protected with a passcode (SERVICE menu).

Note:

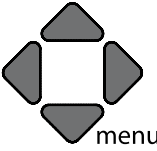
HOLD is not active during Diagnostics mode!

Action	Key	Remark
Activate Diagnostics		Press menu key to call the selection menu. (Display color changes to turquoise.) Select DIAG using ◀ ▶ keys, press enter to confirm.
Select diagnostics option		Use ◀ ▶ keys to select from: CALDATA SENSOR SELFTEST LOGBOOK MONITOR VERSION See next pages for further proceeding.
Exit	meas	Exit by pressing meas .

Diagnosics

Display	Menu item
 <p>The display shows 'd 1A6' at the top. Below it, 'CALDATA' is displayed with 'LO' to its right. Navigation arrows are visible on the left and right sides. A small 'diag' label is at the bottom center.</p>	<p>Displaying the calibration data Select CALDATA using ◀ ▶, press enter to confirm. Use the ◀ ▶ keys to select the desired parameter from the bottom line of the display (LAST_CAL CELLFACTOR ZERO). The selected parameter is shown in the main display.</p>
 <p>The display shows '27.09.07' at the top. Below it, 'LAST_CAL' is displayed with 'CE' to its right. Navigation arrows are visible on the left and right sides. A small 'diag' label is at the bottom center.</p>	<p>Press meas to return to measurement.</p>

Display

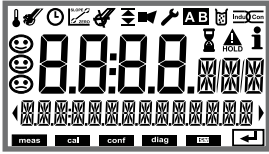

Menu item

Device self-test

(To abort, you can press **meas.**)

- 1) **Display test:** Display of all segments with changing background colors white/green/red. Press **enter** to proceed.



- 2) **RAM test:** Hourglass blinks, then display of --PASS-- or --FAIL--
Press **enter** to proceed.

- 3) **EEPROM test:** Hourglass blinks, then display of --PASS-- or --FAIL--
Press **enter** to proceed.

- 4) **FLASH test:** Hourglass blinks, then display of --PASS-- or --FAIL--
Press **enter** to proceed.

- 5) **Module test:** Hourglass blinks, then display of --PASS-- or --FAIL--
Press **enter** or **meas** to return to measuring mode.

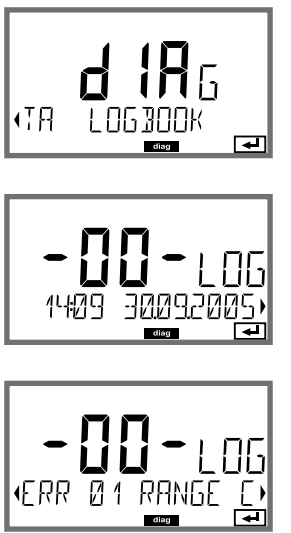
Diagnostics

Display	Menu item
	<p>Displaying the logbook entries (TAN SW-A002) Select LOGBOOK using ◀ ▶, press enter to confirm.</p> <p>By using the ▲ ▼ keys, you can scroll backwards and forwards through the logbook (entries -00-...-99-), -00- being the last entry.</p> <p>If the display is set to date/time, you can search for a particular date using the ▲ ▼ keys. Press ◀ ▶ to view the corresponding message text.</p> <p>If the display is set to the message text, you can search for a particular message using the ▲ ▼ keys. Press ◀ ▶ to display the date and time.</p> <p>Press meas to return to measurement.</p>
	<p>Extended logbook / Audit Trail (TAN SW-A003) By using the ▲ ▼ keys, you can scroll backwards and forwards through the extended logbook (entries -000-...-199-), -000- being the last entry.</p> <p>Display: CFR Audit Trail also records function activations (CAL CONFIG SERVICE), some Sensoface messages, and opening of the enclosure.</p>
<p>Display example:</p> 	<p>Displaying the currently measured values (sensor monitor) Select MONITOR using ◀ ▶, press enter to confirm. Use the ◀ ▶ keys to select the desired parameter from the bottom line of the display (R_COND G_COND RTD TEMP I-INPUT (Option) OPERATION TIME CIP SIP). The selected parameter is shown in the main display.</p> <p>Press meas to return to measurement.</p>

Display



Menu item

Version

Here, you find the data you require for requesting a device-specific Option.

Display of **device type**, **software/hardware version**, and **serial number** for all device components.



Use the ▲ ▼ keys to switch between software and hardware version. Press **enter** to proceed to next device component.



In the Service mode you can access the following menus:

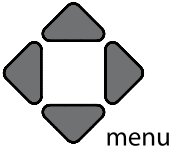

MONITOR	Displaying currently measured values.
OUT1	Testing current output 1.
OUT2	Testing current output 2. (Only if equipped with 2nd current output.)
CODES	Assigning and editing passcodes.
DEFAULT	Resetting the device to factory settings.
OPTION	Enabling options via TAN.

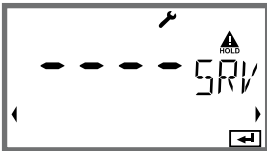
Note:

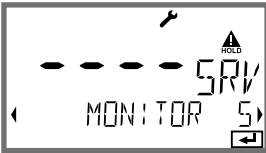





























HOLD is active during Service mode!







Action	Key/Display	Remark
Activate Service		Press menu key to call the selection menu. Select SERVICE using ◀ ▶ keys, press enter to confirm.
Passcode		Enter passcode "5555" for service mode using the ▲ ▼ ◀ ▶ keys. Press enter to confirm.
Display		In Service mode the following icons are displayed: <ul style="list-style-type: none"> • [diag] mode indicator • HOLD triangle • Service (wrench)
Exit	meas	Exit by pressing meas .



Menu item	Remark
 A screenshot of a device's LCD display. The top line shows a dashed line followed by '5.0V' and a 'HOLD' indicator with a triangle. The second line shows 'MONITOR' in the center. Navigation arrows are visible on the left and right sides.	<p>Displaying currently measured values (sensor monitor) with HOLD mode activated: Select MONITOR using ◀ ▶, press enter to confirm. Select variable in the bottom text line using ◀ ▶.</p> <p>The selected parameter is shown in the upper display line. As the device is in HOLD mode, you can perform validations using simulators without influencing the signal outputs.</p> <p>Return to Service menu: Hold meas depressed for longer than 2 sec. Press meas once more to return to measurement.</p>
 A screenshot of a device's LCD display. The top line shows '12.2 mA' and a 'HOLD' indicator with a triangle and an 'i' symbol. The second line shows 'OUT 1' on the left and '12.2 mA' on the right. Navigation arrows are visible on the left and right sides.	<p>Specifying the current at outputs 1 and 2: Select OUT1 or OUT2 using the ◀ ▶ keys, press enter to confirm. Enter a valid current value for the respective output using ▲ ▼ ◀ ▶ keys. Press enter to confirm. For checking purposes, the actual output current is shown in the bottom right corner of the display. End by pressing enter or meas. OUT2: Only if equipped with 2nd current output.</p>

Menu item	Remark
 <p>The LCD display shows '0000' in large digits. To the right, there is a 'PWR' icon with a triangle and 'HOLD' text. Below the digits, 'DIAG' and 'HOLD' are visible as menu options. A right arrow is at the bottom right.</p>	<p>Assigning passcodes: In the "SERVICE - CODES" menu you can assign passcodes to DIAG, HOLD, CAL, CONF and SERVICE modes (Service preset to 5555).</p> <p>When you have lost the Service passcode, you have to request an "Ambulance TAN" from the manufacturer specifying the serial number of your device. To enter the "Ambulance TAN", call the Service function and enter passcode 7321. After correct input of the ambulance TAN the device signals "PASS" for 4 sec and resets the Service passcode to 5555.</p>
 <p>The LCD display shows three dashes '---' above the text 'FACTORY SETTING'. To the right, there is a 'PWR' icon with a triangle and 'HOLD' text, and an information icon 'i'. A right arrow is at the bottom right.</p>	<p>Reset to factory settings: In the "SERVICE - DEFAULT" menu you can reset the device to factory settings.</p> <p>NOTICE After a reset to factory setting the device must be reconfigured completely, including the sensor parameters!</p>
 <p>The LCD display shows '0000' in large digits. To the right, there is a 'PWR' icon with a triangle and 'HOLD' text, and 'TAN' text. Below the digits, 'OPT: LOGBOOK' is visible. A right arrow is at the bottom right.</p>	<p>Option request: Communicate the serial number and hardware/software version of your device to the manufacturer. These data can be viewed in the Diagnostics/Version menu.</p> <p>The "transaction number" (TAN) you will then receive is only valid for the device with the corresponding serial number.</p> <p>Releasing an option: Options come with a "transaction number" (TAN). To release the option, enter this TAN and confirm by pressing enter.</p>

Operating States

Operating status	OUT 1	OUT 2	Time out
Measuring			-
Diag			60 s
CAL_SOL Calibration solution			No
CAL_CELL Cell factor			No
P_CAL Product cal S1			No
P_CAL Product cal S2			No
CAL_ZERO Zero cal			No
CAL_RTD Temp adjustment			No
CONF ParSet A			20 min
CONF ParSet B			20 min
SERVICE MONITOR			20 min
SERVICE OUT 1			20 min
SERVICE OUT 2			20 min
SERVICE IRDA			20 min
SERVICE CODES			20 min

Operating status	OUT 1	OUT 2	Time out
SERVICE DEFAULT			20 min
SERVICE OPTION			20 min
HOLD input			No

Explanation:  as configured (Last/Fix or Last/Off)
 active  manual

Maintenance and Repair

Maintenance

Stratos Pro does not require maintenance.

If maintenance work (e.g., sensor replacement) has to be performed at the measuring point, you must activate the function check (HOLD) mode on the device as follows:

- Opening the Calibration menu
- Opening the Service menu
- Opening the Configuration menu

Repair

The Stratos Pro and the measuring modules cannot be repaired by the user. To request a repair, please contact Knick Elektronische Messgeräte GmbH & Co. KG by visiting www.knick.de.

A201B/X: Supply Units and Connection

Recommended Power Supply Units	Order No.
Stratos Pro A201X, Zone 1:	
Repeater power supply, Ex, 90...253 V AC, output 4...20 mA	WG 21 A7
Repeater power supply, Ex, 90...253 V AC, HART, output 4...20 mA	WG 21 A7 Opt. 470
Repeater power supply, Ex, 24 V AC/DC, output 4...20 mA	WG 21 A7 Opt. 336
Repeater power supply, Ex, 24 V AC/DC, HART, output 4...20 mA	WG 21 A7 Opt. 336, 470
Stratos Pro A201B, Zone 2:	
Repeater power supply, non-Ex, 24 V DC, output 4...20 mA	IsoAmp PWR B 10116
Repeater power supply, non-Ex, 24 V DC, HART, output 0/4...20 mA / 0...10 V	IsoAmp PWR A 20100

Connection to Supply Units

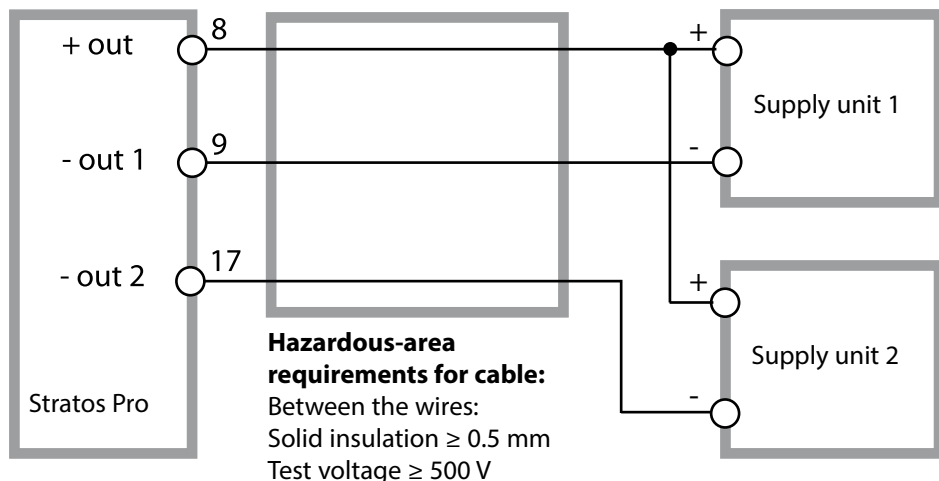

Product Line and Accessories

Order Code Stratos Pro A201

Example	A	2	0	1	X	-	MSCONDI	-	1	TAN
2-wire / 4-20 mA	A	2								B,C,E
Communication										
Without (HART retrofittable via TAN)			0							A
Version number										
Version				1						
Approvals										
General Safety					N					
ATEX / IECEx Zone 2					B					
ATEX / IECEx / FM Zone 1 / CI 1 Div 1					X					
Measuring channel										
Memosens pH / Redox	digital						MSPH			G
Memosens Cond	digital						MSCOND			
Memosens Condi	digital						MSCONDI			
Memosens Oxy	digital						MSOXY			
Dual COND (2x2-electrode sensors, analog)					N		CC			
pH / ORP value (ISM digital per TAN)	Measuring module						PH			F, G
Cond, 2-/4-electrode	Measuring module						COND			
Conductivity, electrodeless	Measuring module						CONDI			
Oxygen (ISM digital and traces per TAN)	Measuring module						OXY			D, F
Options										
Without 2nd current output									0	
With 2nd current output									1	
TAN options										
HART							SW-A001			(A)
Logbook							SW-A002			(B)
Extended logbook (Audit Trail)							SW-A003			(C)
Trace oxygen measurement							SW-A004			(D)
Current input + 2 digital inputs							SW-A005			(E)
ISM digital							SW-A006			(F)
Pfudler							SW-A007			(G)
Mounting accessories										
Pipe-mount kit							ZU 0274			
Protective hood							ZU 0737			
Panel-mount kit							ZU 0738			

Specifications

CONDI input	Input for toroidal conductivity sensors with Memosens protocol (e.g., SE680-M) or SE680-K or SE670		
Effective ranges	Conductivity	0.0 µS/cm ... 2000 mS/cm	
Display ranges	Conductivity	000.0 ... 999.9 µS/cm 0.000 ... 9.999 mS/cm 00.00 ... 99.99 mS/cm 000.0 ... 999.9 mS/cm 0000 ... 1999 mS/cm 0.000 ... 9.999 S/cm 00.00 ... 99.99 S/cm	
	Concentration	0.00 ... 9.99 % / 10.0 ... 100.0 %	
	Salinity	0.0 ... 45.0 % (0 ... 35 °C / 32 ... 93 °F)	
	Response (T90)	Approx. 1 s	
Measurement error ^{1,2,3)}	Depending on Memosens		
Temp compensation *	(OFF)	Without	
	(LIN)	Linear characteristic 00.00 ... 19.99%/K (reference temp user-defined)	
	(NLF)	Natural waters to EN 27888 (reference temp 25 °C / 77 °F)	
	(NACL)	Ultrapure water with NaCl traces (0 ... 120 °C / 32 ... 248 °F), reference temp 25 °C / 77 °F	
	(HCL)	Ultrapure water with HCl traces (0 ... 120 °C / 32 ... 248 °F), reference temp 25 °C / 77 °F	
	(NH3)	Ultrapure water with NH3 traces (0 ... 120 °C / 32 ... 248 °F), reference temp 25 °C / 77 °F	
	(NaOH)	Ultrapure water with NaOH traces (0 ... 120 °C / 32 ... 248 °F), reference temp 25 °C / 77 °F	
Concentration determination	-01- NaCl	0 – 26 wt% (0 °C / 32 °F)	... 0 – 28 wt% (100 °C / 212 °F)
	-02- HCl	0 – 18 wt% (-20 °C / -4 °F)	... 0 – 18 wt% (50 °C / 122 °F)
	-03- NaOH	0 – 13 wt% (0 °C / 32 °F)	... 0 – 24 wt% (100 °C / 212 °F)
	-04- H ₂ SO ₄	0 – 26 wt% (-17 °C / 1.4 °F)	... 0 – 37 wt% (110 °C / 230 °F)
	-05- HNO ₃	0 – 30 wt% (-20 °C / -4 °F)	... 0 – 30 wt% (50 °C / 122 °F)

Specifications

Concentration determination (continued)	-06- H ₂ SO ₄	94 – 99 wt% (-17 °C / 1.4 °F)	... 89 – 99 wt% (115 °C / 239 °F)
	-07- HCl	22 – 39 wt% (-20 °C / -4 °F)	... 22 – 39 wt% (50 °C / 122 °F)
	-08- HNO ₃	35 – 96 wt% (-20 °C / -4 °F)	... 35 – 96 wt% (50 °C / 122 °F)
	-09- H ₂ SO ₄	28 – 88 wt% (-17 °C / 1.4 °F)	... 39 – 88 wt% (115 °C / 239 °F)
	-10- NaOH	15 – 50 wt% (0 °C / 32 °F)	... 35 – 50 wt% (100 °C / 212 °F)
	-U1-	Specifiable concentration table	
Sensor standardization	Input of cell factor with simultaneous display of selected process variable and temperature Input of calibration solution conductivity with simultaneous display of cell factor Input of an installation factor Product calibration for conductivity Zero adjustment Temperature probe adjustment		
Permissible cell factor	00.100 ... 19.999 cm ⁻¹		
Permissible zero offset	± 0.5 mS		
Sensocheck	Monitoring of primary and secondary coils and lines for open circuit and of primary coil and lines for short circuit		
Delay	Approx. 30 s		
Sensoface	Provides information on the sensor condition (zero point, Sensocheck)		
Sensor monitor	Direct display of measured values from sensor for validation (resistance/temperature)		
Calibration data	Calibration date, cell factor, zero point		

I input (TAN)	Current input 0/4 ... 20 mA / 50 Ω for external temperature signal		
Start/end of scale	Configurable -50 ... 250 °C / -58 ... 482 °F		
Characteristic	Linear		
Measurement error ^{1,3)}	< 1% current value + 0.1 mA		
HOLD input	Galvanically separated (optocoupler)		
Function	Switches device to HOLD mode		
Switching voltage	0 ... 2 V AC/DC	HOLD inactive	
	10 ... 30 V AC/DC	HOLD active	
CONTROL input	Galvanically separated (optocoupler)		
Function	Selecting parameter set A/B or flow measurement		
Parameter set A/B	Control input	0 ... 2 V AC/DC	Parameter set A
		10 ... 30 V AC/DC	Parameter set B
FLOW	Pulse input for flow measurement 0 ... 100 pulses/s		
Message	via 22 mA		
Display	00.0 ... 99.9 l/h		
Output 1	Current loop, 4 ... 20 mA, floating, protected against inverse polarity HART communication (see further below for specifications)		
Supply voltage	14 ... 30 V		
Process variable *	Conductivity, resistivity, concentration, salinity, or temperature		
Characteristic	Linear, bilinear or logarithmic		
Overrange *	22 mA in the case of error messages		
Output filter *	PT ₁ filter, time constant 0 ... 120 s		
Measurement error ¹⁾	< 0.25 % current value + 0.025 mA		
Start/end of scale *	Configurable within selected range		
Bilinear: Vertex X/Y *	Configurable within selected range		

Specifications

Output 2

For version with 2nd current output only

Current loop, 4 ... 20 mA, floating, reverse polarity protected

Supply voltage

14 ... 30 V

Process variable *

Conductivity, resistivity, concentration, salinity, or temperature

Characteristic

Linear, bilinear or logarithmic

Overrange *

22 mA in the case of error messages

Output filter *

PT, filter, time constant 0 ... 120 s

Measurement error ¹⁾

< 0.25 % of current value + 0.05 mA

Start/end of scale *

Configurable within selected range

Bilinear: Vertex X/Y *

Configurable within selected range

Real-time clock

Different time and date formats selectable

Power reserve

> 5 days

Display

LC display, 7-segment with icons

Main display

Character height approx. 22 mm, unit symbols approx. 14 mm

Secondary display

Character height approx. 10 mm

Text line

14 characters, 14 segments

Sensoface

3 status indicators (friendly, neutral, sad face)

Mode Indicators

meas, cal, conf, diag

Further icons for configuration and messages

Alarm indication

Display blinks, red backlighting

Keypad

Keys: meas, menu, info, 4 cursor keys, enter

HART communication (TAN)

HART version 6

Digital communication by FSK modulation of output current 1

Device identification, measured values, status and messages, parameter setting, calibration, records

FDA 21 CFR Part 11

Access control by editable passcodes

Logbook entry and flag via HART

Message and logbook entry when enclosure is opened

Diagnostic functions

Calibration data	Calibration date, sensor parameters
Device self-test	Display test, automatic memory test (RAM, FLASH, EEPROM), module test
Logbook (TAN)	100 events with date and time
Extended logbook (TAN)	Audit Trail: 200 events with date and time

Service functions

Sensor monitor	Display of direct sensor signals
Current source	Current specifiable for output 1 and 2 (04.00 ... 22.00 mA)
Passcodes	Assigning passcodes for menu access
Factory setting	Resetting all parameters to factory setting
TAN	Enabling optionally available additional functions

Data retention	Parameters, calibration data, logbook > 10 years (EEPROM)
-----------------------	---

Housing

	Molded enclosure, glass fiber reinforced Front unit material: PBT Rear unit material: PC
Mounting	Wall, pipe/post or panel mounting
Color	Gray RAL 7001
Ingress protection	IP66/IP67/TYP E 4X outdoor (with pressure compensation) when the device is closed
Flammability	UL 94 V-0 for external parts
Dimensions	148 mm x 148 mm
Control panel cutout	138 mm x 138 mm acc. to DIN 43 700
Weight	approx. 1200 kg (1.6 kg incl. accessories and packaging)
Cable glands	5 knockouts for M20 x 1.5 cable glands 2 of 5 knockouts for NPT ½" or rigid metallic conduit

Terminals

Screw terminals	for single or stranded wires 0.2... 2.5 mm ²
Tightening torque	0.5 ... 0.6 Nm

Specifications

Wiring

Stripping length Max. 7 mm

Temperature resistance > 75 °C / 167 °F

Rated operating conditions

Climatic class 3K5 according to EN 60721-3-3

Location class C1 according to EN 60654-1

Ambient temperature -20 ... 65 °C / -4 ... 149 °F

Relative humidity 5 ... 95 %

Supply voltage 14 ... 30 V

Transport and storage

Transport / storage temperature -30 ... 70 °C / -22 ... 158 °F

EMC

Emitted interference Class A (industrial applications) ⁴⁾

Immunity to interference Industrial applications

*) User-defined

1) At rated operating conditions

2) ± 1 count

3) Plus sensor error

Calibration Solutions

Potassium Chloride Solutions

(Conductivity in mS/cm)

Temperature [°C]	Concentration ¹		
	0.01 mol/l	0.1 mol/l	1 mol/l
0	0.776	7.15	65.41
5	0.896	8.22	74.14
10	1.020	9.33	83.19
15	1.147	10.48	92.52
16	1.173	10.72	94.41
17	1.199	10.95	96.31
18	1.225	11.19	98.22
19	1.251	11.43	100.14
20	1.278	11.67	102.07
21	1.305	11.91	104.00
22	1.332	12.15	105.94
23	1.359	12.39	107.89
24	1.386	12.64	109.84
25	1.413	12.88	111.80
26	1.441	13.13	113.77
27	1.468	13.37	115.74
28	1.496	13.62	
29	1.524	13.87	
30	1.552	14.12	
31	1.581	14.37	
32	1.609	14.62	
33	1.638	14.88	
34	1.667	15.13	
35	1.696	15.39	
36		15.64	

1) Data source: K. H. Hellwege (Editor), H. Landolt, R. Börnstein: Zahlenwerte und Funktionen ..., volume 2, part. volume 6

Calibration Solutions

Sodium Chloride Solutions

(Conductivity in mS/cm)

Temperature	Concentration		
[°C]	0.01 mol/l ¹⁾	0,1 mol/l ¹⁾	Saturated ²⁾
0	0.631	5.786	134.5
1	0.651	5.965	138.6
2	0.671	6.145	142.7
3	0.692	6.327	146.9
4	0.712	6.510	151.2
5	0.733	6.695	155.5
6	0.754	6.881	159.9
7	0.775	7.068	164.3
8	0.796	7.257	168.8
9	0.818	7.447	173.4
10	0.839	7.638	177.9
11	0.861	7.831	182.6
12	0.883	8.025	187.2
13	0.905	8.221	191.9
14	0.927	8.418	196.7
15	0.950	8.617	201.5
16	0.972	8.816	206.3
17	0.995	9.018	211.2
18	1.018	9.221	216.1
19	1.041	9.425	221.0
20	1.064	9.631	226.0
21	1.087	9.838	231.0
22	1.111	10.047	236.1
23	1.135	10.258	241.1
24	1.159	10.469	246.2
25	1.183	10.683	251.3
26	1.207	10.898	256.5
27	1.232	11.114	261.6
28	1.256	11.332	266.9
29	1.281	11.552	272.1
30	1.306	11.773	277.4
31	1.331	11.995	282.7
32	1.357	12.220	288.0
33	1.382	12.445	293.3
34	1.408	12.673	298.7
35	1.434	12.902	304.1
36	1.460	13.132	309.5

1) Data source: Test solutions calculated according to DIN IEC 746-3

2) Data source: K. H. Hellwege (Editor), H. Landolt, R. Börnstein: Zahlenwerte und Funktionen ..., volume 2, part. volume 6

Concentration Measurement

Ranges

Substance	Concentration ranges		
NaCl	0-26 wt% (0 °C / 32 °F) 0-26 wt% (100 °C / 212 °F)		
Configuration	-01-		
HCl	0-18 wt% (-20 °C / -4 °F) 0-18 wt% (50 °C / 122 °F)	22-39 wt% (-20 °C / -4 °F) 22-39 wt% (50 °C / 122 °F)	
Configuration	-02-	-07-	
NaOH	0-13 wt% (0 °C / 32 °F) 0-24 wt% (100 °C / 212 °F)	15-50 wt% (0 °C / 32 °F) 35-50 wt% (100 °C / 212 °F)	
Configuration	-03-	-10-	
H ₂ SO ₄	0-26 wt% (-17 °C/-1.4 °F) 0-37 wt% (110 °C/230 °F)	28-77 wt% (-17 °C/-1.4 °F) 39-88 wt% (115 °C/239 °F)	94-99 wt% (-17 °C/-1.4 °F) 89-99 wt% (115 °C/239 °F)
Configuration	-04-	-09-	-06-
HNO ₃	0-30 wt% (-20 °C / -4 °F) 0-30 wt% (50 °C / 122 °F)	35-96 wt% (-20 °C / -4 °F) 35-96 wt% (50 °C / 122 °F)	
Configuration	-05-	-08-	

For the solutions listed above, the device can determine the substance concentration from the measured conductivity and temperature values in % by wt. The measurement error is made up of the sum of measurements errors during conductivity and temperature measurement and the accuracy of the concentration curves stored in the device. We recommend to calibrate the device together with the sensor, e.g. directly to concentration using the CAL_CELL method. For exact temperature measurement, you should perform a temperature probe adjustment. For measuring processes with rapid temperature changes, a separate temperature probe with fast response should be used.

When measuring processes such as dilution or intensification of CIP solutions (Clean-In-Place), it is helpful to switch between the parameter sets for measuring the process medium and for measuring the CIP solution.

For specification of a concentration solution for conductivity measurement, see page 45.

Concentration Curves

-01- Sodium chloride solution NaCl

← -01- →

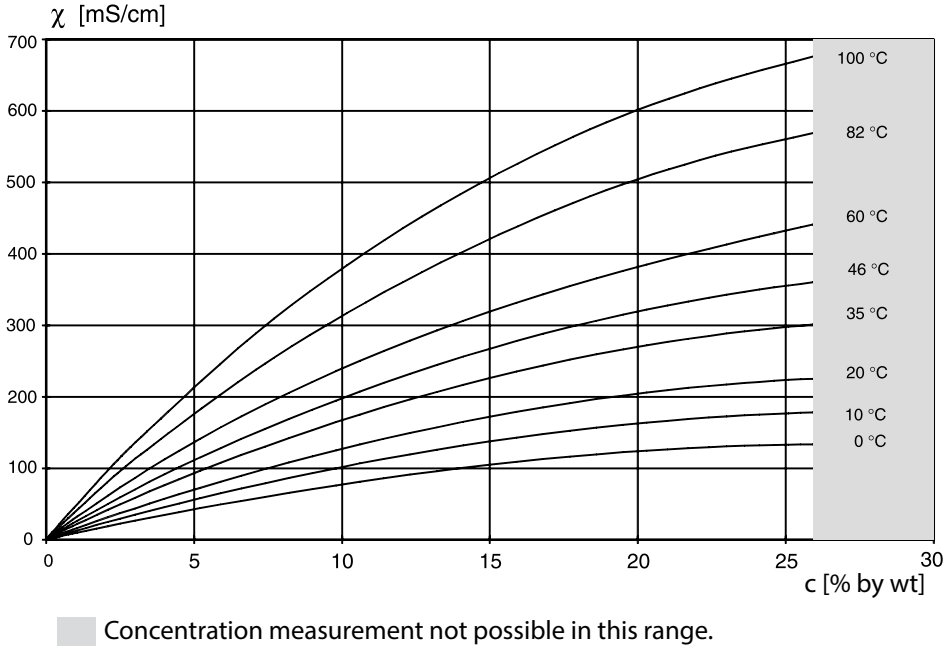

Conductivity versus substance concentration and process temperature for sodium chloride solution (NaCl)

-02- Hydrochloric acid HCl

-07-

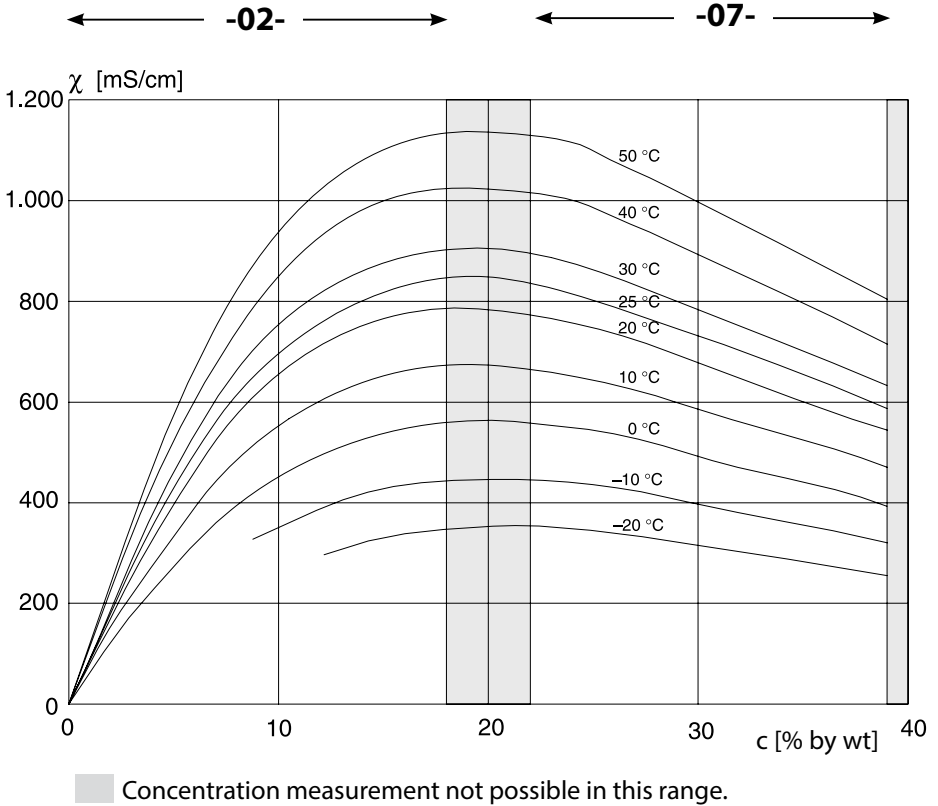

Conductivity versus substance concentration and process temperature for hydrochloric acid (HCl)

Source: Haase/Sauermann/Dücker; Z. phys. Chem. New Edition, Vol. 47 (1965)

Concentration Curves

-03- Sodium hydroxide solution NaOH

-10-

← -03- → ← -10- →

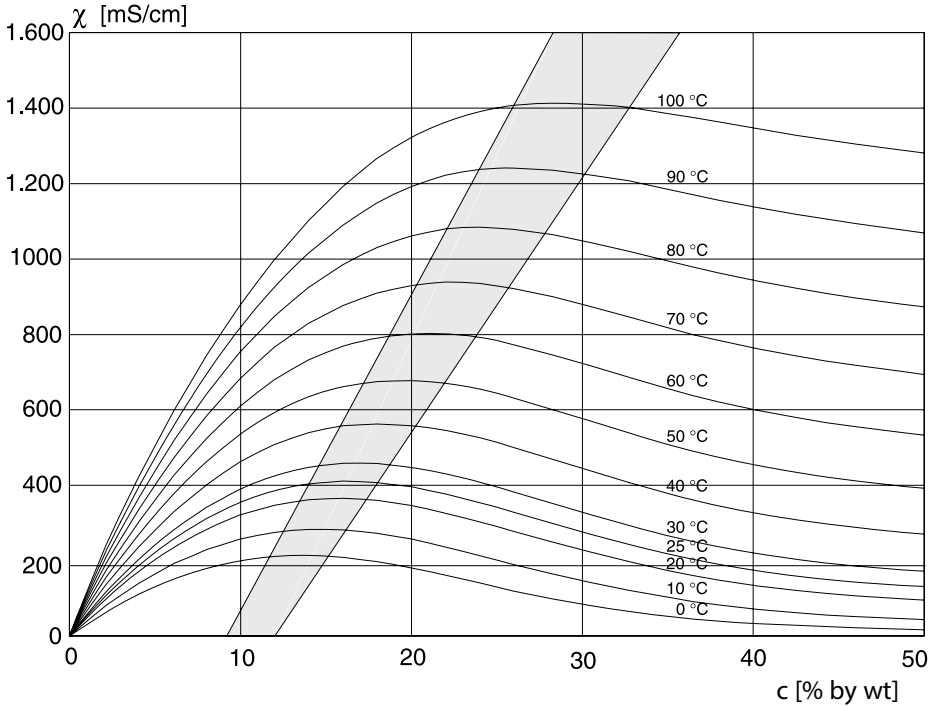

■ Concentration measurement not possible in this range.

Conductivity versus substance concentration and process temperature for sodium hydroxide solution (NaOH)

-04- Sulfuric acid H_2SO_4

-06-

-09-

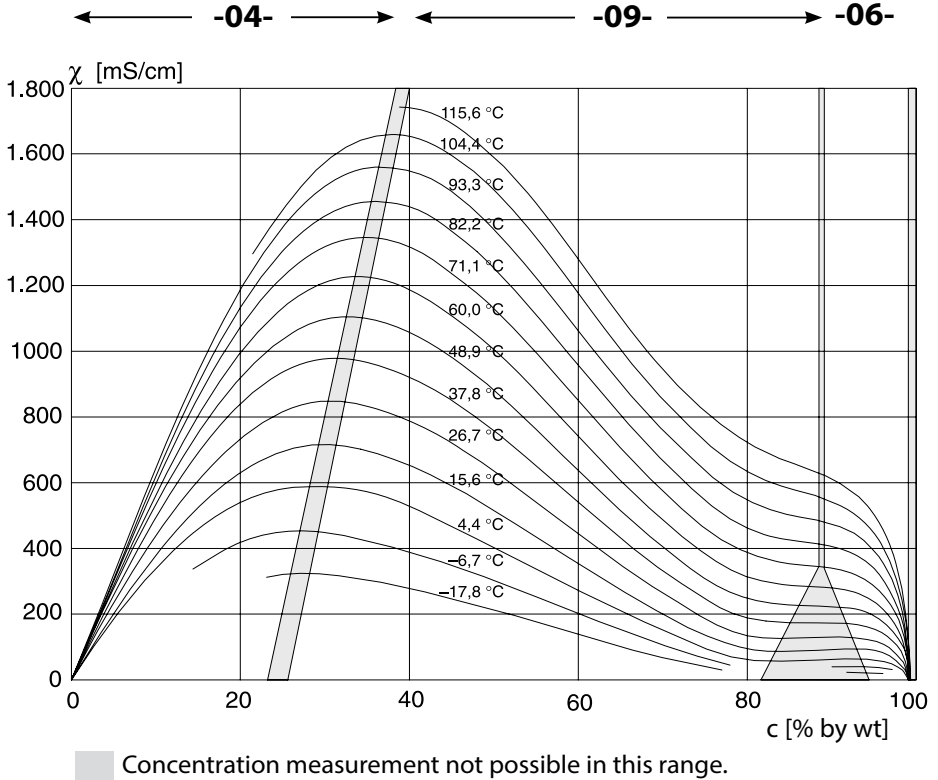

Conductivity versus substance concentration and process temperature for sulfuric acid (H_2SO_4)

Source: Darling; Journal of Chemical and Engineering Data; Vol.9 No.3, July 1964

Concentration Curves

-05- Nitric acid HNO_3

-08-

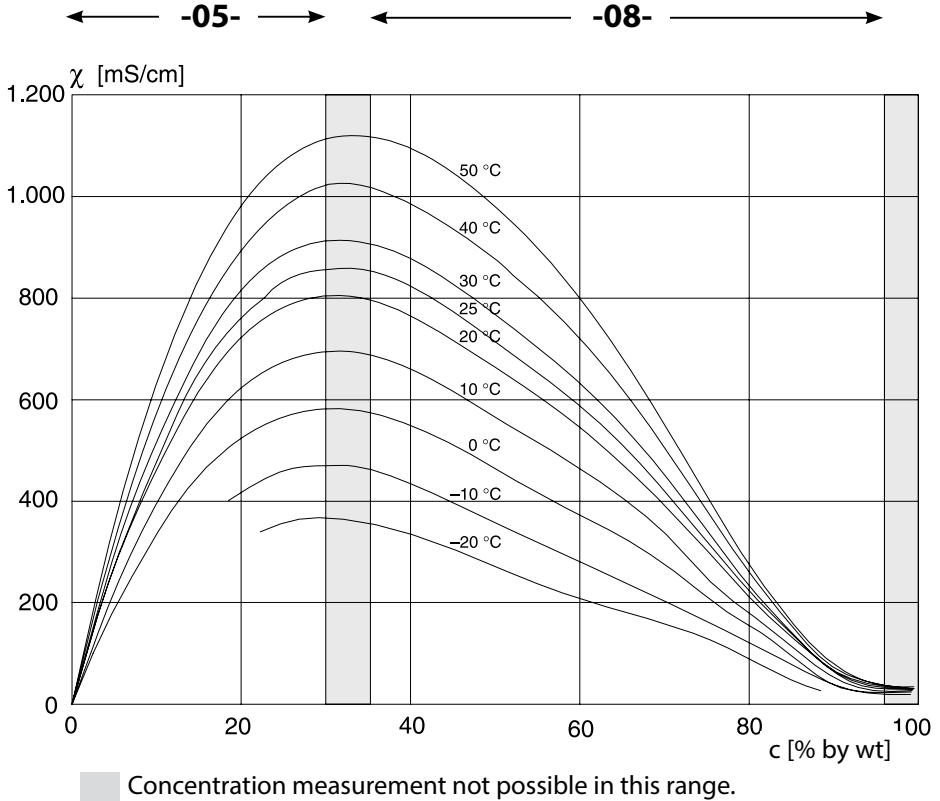

Conductivity versus substance concentration and process temperature for nitric acid (HNO_3)

Source: Haase/Sauermann/Dücker; Z. phys. Chem. New Edition, Vol. 47 (1965)

Alarm condition:

- The display backlighting turns **red**
- The alarm icon  is displayed
- The complete measured-value display blinks
- **"ERR xxx"** is displayed in the lower menu line

Press the [**info**] key to view a short error text:

- The error text appears in the lower menu line
- The main display reads **"InFo"**.

Parameter errors:

Configuration data such as current range, limit values, etc are checked during the input.

If they are out of range,

- **"ERR xxx"** is displayed for 3 sec,
- the display backlighting flashes red,
- the respective maximum or minimum value is shown,
- input must be repeated.

If a faulty parameter arrives through the interface (HART),

- an error message will be displayed: **"ERR 100...199"**
- the faulty parameter can be localized by pressing the [**info**] key

Calibration errors:

If errors occur during calibration,

- an error message will be displayed

Sensoface:

If the Sensoface becomes sad,

- the display backlighting will turn magenta (purple)
- the cause can be seen by pressing the **info** key
- the calibration data can be seen in the Diagnostics menu

Error Messages

Error	Info text (is displayed in case of fault when the Info key is pressed)	Problem Possible causes
ERR 99	DEVICE FAILURE	Error in factory settings EEPROM or RAM defective This error message only occurs in the case of a total defect. The device must be repaired and recalibrated at the factory.
ERR 98	CONFIGURATION ERROR	Error in configuration or calibration data Memory error in device program Configuration or calibration data defective; completely reconfigure and recalibrate the device.
ERR 97	NO MODULE INSTALLED	"MEMOSENS" not selected as sensor type *
ERR 96	WRONG MODULE	"MEMOSENS" not selected as sensor type *
ERR 95	SYSTEM ERROR	System error Restart required. If error still persists, send in the device for repair.
ERR 01	NO SENSOR	No sensor * The sensor is not recognized: Check connections. Check cables/sensor. Replace as required.
ERR 02	WRONG SENSOR	Wrong sensor * Replace the sensor.
ERR 04	SENSOR FAILURE	Failure in sensor * Replace the sensor.

*) Memosens sensors

Error	Info text (is displayed in case of fault when the Info key is pressed)	Problem Possible causes
ERR 10	CONDUCTANCE TOO HIGH	Measuring range of conductance exceeded > 3500 mS
ERR 11	CONDUCTIVITY RANGE CONCENTRATION RANGE SALINITY RANGE	Display range limits exceeded Cond > 1999 mS/cm > 99.99 S/m Conc > 99.9 % SAL > 45.0 ‰
ERR 13	TEMPERATURE RANGE	Temperature range limits exceeded Connect the sensor, check the sensor cable and replace if necessary, check the sensor connection, adjust the parameter settings.
ERR 15	SENSOCHECK	Sensocheck
ERR 60	OUTPUT LOAD	Load error Check the current loop, deactivate unused current outputs.
ERR 61	OUTPUT 1 TOO LOW	Output current 1 < 0 (3.8) mA
ERR 62	OUTPUT 1 TOO HIGH	Output current 1 > 20.5 mA
ERR 63	OUTPUT 2 TOO LOW	Output current 2 < 0 (3.8) mA
ERR 64	OUTPUT 2 TOO HIGH	Output current 2 > 20.5 mA
ERR 72	FLOW TOO LOW	Flow too low
ERR 73	FLOW TOO HIGH	Flow too high

Error Messages

Error	Info text (is displayed in case of fault when the Info key is pressed)	Problem Possible causes
ERR 100	INVALID SPAN OUT1	Span Out1 configuration error Selected span too small
ERR 101	INVALID SPAN OUT2	Span Out2 configuration error Selected span too small
ERR 105	INVALID SPAN I-INPUT	Configuration error Current input
ERR 108	OUT1 INVALID CORNER X/Y	Bilinear curve: Invalid vertex point
ERR 109	OUT2 INVALID CORNER X/Y	

Disposal

Local codes and regulations must be observed when disposing of the product.

Returns

If required, send the product in a clean condition and securely packed to your local contact. See www.knick.de.

Sensoface

(Sensochek must have been activated during configuration.)



The smiley in the display (Sensoface) alerts to sensor problems (defective sensor, defective cable, maintenance required). The



permitted calibration ranges and the conditions for a friendly, neutral, or sad Sensoface are summarized in the following



table. Additional icons refer to the error cause.

Sensochek

Continuously monitors the sensor and leads for short circuits or open circuits. Critical values make the Sensoface “sad” and the corresponding icon blinks:



The Sensochek message is also output as error message Err 15.

The display backlighting turns red, output current 1 is set to 22 mA (when configured correspondingly).





Sensochek can be switched off during configuration (then Sensoface is also disabled).

Exception:

After a calibration a smiley is always displayed for confirmation.

Note:

The worsening of a Sensoface criterion leads to the devaluation of the Sensoface indicator (Smiley becomes “sad”). An improvement of the Sensoface indicator can only take place after calibration or removal of the sensor defect.

Display	Problem	Status
	Sensor defect	 Wrong or defective sensor or excessive cable capacitance (see also error message Err 15).
	Temperature	 Temperature outside range for TC, conc, sal

HART: Typical Applications

(SW-A001)

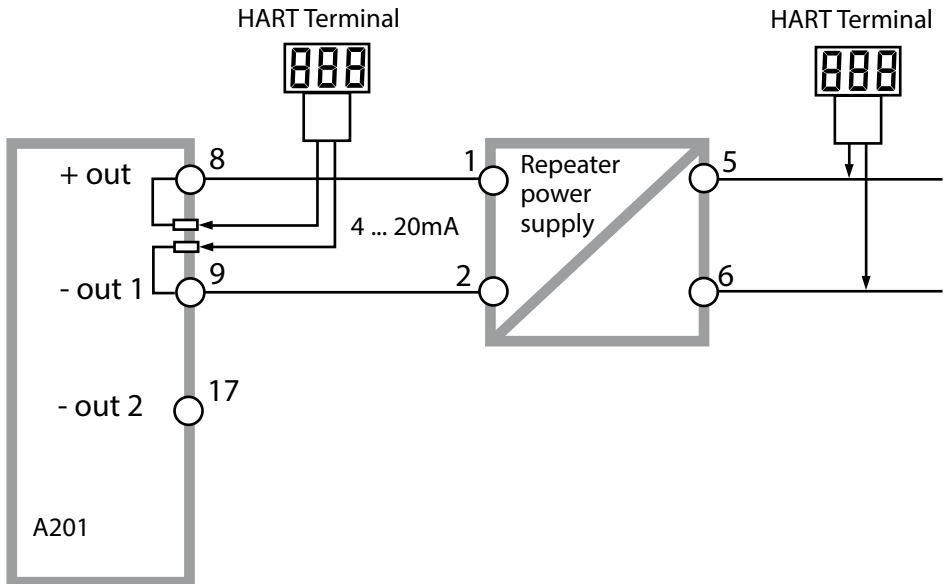
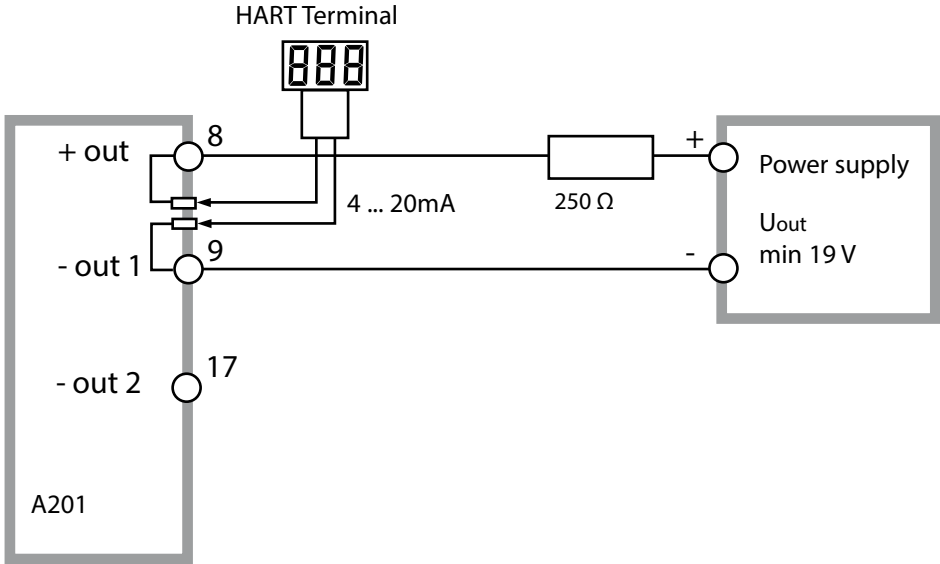

Conformity with FDA 21 CFR Part 11

In their directive “Title 21 Code of Federal Regulations, 21 CFR Part 11, Electronic Records; Electronic Signatures” the American health agency FDA (Food and Drug Administration) regulates the production and processing of electronic documents for pharmaceutical development and production. This results in requirements for measuring devices used for corresponding applications. The following features ensure that the measuring devices of this Series meet the demands of FDA 21 CFR Part 11:

Electronic Signature – Passcodes

Access to the device functions is regulated and limited by individually adjustable codes – “Passcodes” (see SERVICE). This prevents unauthorized modification of device settings or manipulation of the measurement results. Appropriate use of these passcodes makes them suitable as electronic signature.

Audit Trail

Every (manual) change of device settings can be automatically documented. Each change is tagged with a “Configuration Change Flag”, which can be interrogated and documented using HART communication. Altered device settings or parameters can also be retrieved and documented using HART communication.

Extended logbook (TAN SW-A003)

Audit Trail also records function activations (CAL, CONFIG, SERVICE), some Sensoface messages (cal timer, wear, SIP, CIP) and opening of the enclosure.

Index

A

Access code assignment 97
Accessories 102
Activating an option 97
AIR-SET calibration 86
Alarm 30
Alarm and HOLD messages 31
Alarm settings 70
Ambulance TAN 97
Assembly 13
Audit Trail 125
Audit Trail, diagnostics 92
Autorange 53

B

Backlighting 22
Block diagram 12

C

Cable glands 17
Calibration 79
Calibration by entry of cell factor 82
Calibration data, display 90
Calibration errors 117
Calibration, general 27
Calibration mode 79
Calibration solutions 109
Calibration with calibration solution 80
Calibration with installation factor 83
CIP / SIP 49
Commissioning 7
Concentration curves: hydrochloric acid HCl 113
Concentration curves: nitric acid HNO₃ 116
Concentration curves: sodium chloride solution NaCl 112
Concentration curves: sodium hydroxide solution NaOH 114
Concentration curves: sulfuric acid H₂SO₄ 115
Concentration measurement, custom concentration solution 45
Concentration ranges 111

- Concentration solution, selection 44
- Configuration, alarm 70
- Configuration, CONTROL input 68
- Configuration, current output 1 52
- Configuration, current output 2 62
- Configuration, display backlighting 76
- Configuration, general 27
- Configuration, individual settings 39
- Configuration, measuring point 76
- Configuration, menu groups 33
- Configuration, menu structure 32
- Configuration, output current during Error and HOLD 60
- Configuration, overview 35
- Configuration, Sensocheck 70
- Configuration, sensor 42
- Configuration, sensor verification (TAG, GROUP) 50
- Configuration, temperature compensation 64
- Configuration, time and date 74
- Configuration, time averaging filter 58
- Connection to supply units 101
- CONTROL, alarm settings 72
- CONTROL, configuring the input 68
- Control drawings 3
- CONTROL input 31
- Control inputs 11
- Current start / end 53

D

- Data logger, explanation 10
- Date and time (configuration) 74
- Date and time (usage) 75
- Date, display 88
- Declaration of Conformity 3
- Decommissioning 121
- Device self-test 91
- Device type, display 93
- Diagnostics, calibration data 90
- Diagnostics, device self-test 91

Index

Diagnostics, general 27
Diagnostics, logbook 92
Diagnostics mode 89
Diagnostics, sensor monitor 92
Diagnostics, version 93
Dimensions 14
Display 22
Display backlighting 22
Display data in Diagnostics mode 89
Display test 91
Disposal 121
Documentation: package contents 3

E

EEPROM test 91
Electrical installation 17
Electronic Signature 125
Enabling an option 97
Enclosure 14
Enclosure components 13
Entering values 24
Error codes 118
Error handling 117
EU Declaration of Conformity 3
Extended logbook, Audit Trail 125
Extended logbook, diagnostics 92

F

FDA 21 CFR Part 11 125
FLASH test 91
FLOW 69
Flow measurement, configuration 68

G

GROUP (measuring points) 77

H

HART, typical applications 124
HOLD, configuration 61
HOLD mode, description 29
HOLD mode, exit 29
HOLD mode, external activation 30
HOLD mode, manual activation 30
HOLD mode, output signal 29

I

Info text 118
Installation, notices 17
Intended use 7

K

Keypad 21

L

Logarithmic curve 56
Logbook, diagnostics 92

M

Maintenance 100
Manual switchover of parameter sets A/B 34
Measured values, display 92
Measurement method, selection 42
Measuring mode 88
Measuring mode, overview 23
Measuring points (TAG/GROUP) 77
Memosens, connection via RS-485 19
Menu structure 28
Menu structure of configuration 32
Messages (ERR) 118
Message via CONTROL input 31
Module test 91
Monitoring the sensor lines 36
Monitoring the temperature probe 71
Mounting options 9
Mounting plan 14

O

- Operating modes 27
- Operating mode, selection 24
- Operating states 98
- Option request 97
- Option request: Conditions 93
- Options, overview 102
- Order code 102
- Output current, display 88
- Output current range 62
- Output current, specify value 96
- Output filter 58
- Output signal during HOLD 29
- Output signal during HOLD, configuration 61
- Overview, device properties 9

P

- Package contents 13
- Package contents: documentation 3
- Panel mounting 16
- Parameter error 117
- Parameter set A/B 33
- Parameter set A/B, display 88
- Parameter set A/B, introduction 10
- Parameter set selection via external signal 68
- PARSET 34
- Pipe mounting 15
- Power supply units 101
- Product calibration 84
- Product line 102
- Protective hood 15

Q

- Quickstart guides 3

R

RAM test 91
Rated operating conditions 108
Rating plates 18
Repair 100
Reset to factory settings 97
Returns 121

S

Safety 7
Safety guide 3
SE 670/680, wiring (via RS-485) 20
Selection menu 24
Sensocheck, configuration 70
Sensocheck, description 122
Sensoface, description 122
Sensoface, troubleshooting 117
Sensor connection, assignment 19
Sensor line monitoring 36
Sensor monitor, diagnostics 92
Sensor monitor (Service) 96
Sensor type selection 42
Sensor verification (TAG, GROUP) 51
Serial number, display 93
Service 95
Service, factory setting 97
Service, general 27
Service, output current, specify value 96
Service, passcode assignment 97
Service passcode lost 97
Service, sensor monitor 96
Setting the passcodes 97
Signal colors 22, 26
Signal lines 19
Signal outputs 11
Software version, display 93
Specifications 103
Supplemental directives 2
Supply units 101

T

- Tag number, display 88
- TAG (point of measurement) 77
- TAN input 97
- TAN options, activation 97
- TAN options, overview 102
- Technical data 103
- Tempcheck 70
- Temperature compensation 65
- Temperature probe adjustment 87
- Temperature probe, monitoring 71
- Temperature unit 46
- Terminal assignments 18
- Test report 2.2 3
- Time and date (configuration) 74
- Time and date (usage) 75
- Time averaging filter 59
- Time, display 88
- Transaction number (TAN) 97

U

- User interface 21

W

- Weather protector 15
- Wiring 19
- Wiring example 20
- Wiring, power supply units 101

Z

- Zero calibration 86



Knick
Elektronische Messgeräte
GmbH & Co. KG

Headquarters

Beuckestraße 22 • 14163 Berlin

Germany

Phone: +49 30 80191-0

Fax: +49 30 80191-200

info@knick.de

www.knick.de

Local Contacts

www.knick-international.com

Translation of the original instructions

Copyright 2022 • Subject to change

Version: 4 • This document was published on February 18, 2022.

The latest documents are available for download on our website under the corresponding product description.



099491

TA-212.135-MS-KNEN04