

# Unical 9000/Protos II 4400

Process Analysis System

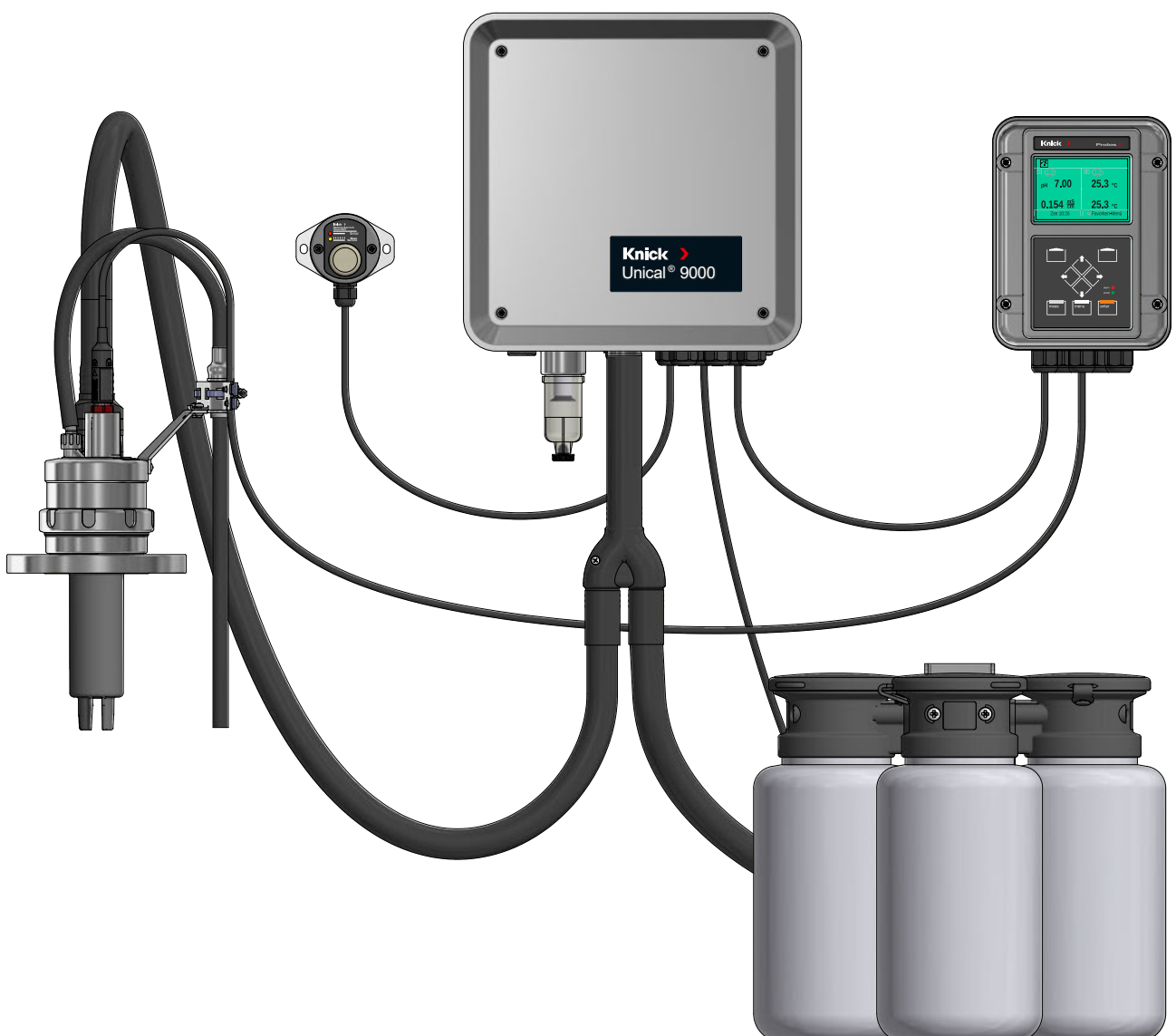

Read before installation.  
Keep for future use.



## Supplemental Directives

READ AND SAVE THIS DOCUMENT FOR FUTURE REFERENCE. BEFORE ATTEMPTING TO ASSEMBLE, INSTALL, OPERATE OR MAINTAIN THE PRODUCT, PLEASE ENSURE A COMPLETE UNDERSTANDING OF THE INSTRUCTIONS AND RISKS DESCRIBED HEREIN. ALWAYS OBSERVE ALL SAFETY INFORMATION. FAILURE TO COMPLY WITH INSTRUCTIONS IN THIS DOCUMENT COULD RESULT IN SERIOUS INJURY AND/OR PROPERTY DAMAGE. THIS DOCUMENT IS SUBJECT TO CHANGE WITHOUT NOTICE.



These supplemental directives explain how safety information is laid out in this document and what content it covers.

### Safety Chapter





This document's safety chapter is designed to give the reader a basic understanding of safety. It illustrates general hazards and gives strategies on how to avoid them.

### Warnings

This document uses the following warnings to indicate hazardous situations:

Symbol	Category	Meaning	Remark
	WARNING	Designates a situation that can lead to death or serious (irreversible) injury.	The warnings contain information on how to avoid the hazard.
	CAUTION	Designates a situation that can lead to slight or moderate (reversible) injury.	
None	NOTICE	Designates a situation that can lead to property or environmental damage.	

## Symbols Used in this Document

Symbol	Meaning
	Reference to additional information
	Interim or final result in instructions for action
	Sequence of figures attached to an instruction for action
	Item number in a figure
<b>(1)</b>	Item number in text

## Related Documents

- Retractable fitting User Manual. → [www.knick.de](http://www.knick.de)
- Protos II 4400 industrial transmitter User Manual. → [knick.de](http://knick.de)
- Protos modules User Manuals. → [www.knick.de](http://www.knick.de)
- Sensor User Manual. → [www.knick.de](http://www.knick.de)

## Table of Contents

<b>1 Safety</b> .....	<b>5</b>
1.1 Intended Use .....	5
1.2 Personnel Requirements .....	5
1.3 Safeguards.....	6
1.4 Residual Risks .....	6
1.5 Hazardous Substances .....	7
1.6 Operation in Explosive Atmospheres .....	7
1.7 Operation and Installation.....	7
1.8 Maintenance and Spare Parts.....	8
1.9 Safety Training .....	8
<b>2 Product</b> .....	<b>9</b>
2.1 Package Contents .....	9
2.2 Product Identification.....	9
2.2.1 Example of a Version .....	9
2.2.2 Product Code .....	10
2.3 Nameplates .....	11
2.4 Symbols and Markings on the Product.....	13
2.5 Process Analysis System Design .....	14
2.5.1 Electro-Pneumatic Controller Design and Function.....	15
2.5.2 Media Adapter with Metering Pumps and Containers Design and Function .....	18
2.5.3 Service Switch Design and Function.....	19
2.5.4 Media Connection Design and Function.....	20
2.5.5 Changes for Different Conditions.....	20
<b>3 Installation</b> .....	<b>21</b>
3.1 General Installation Instructions .....	21
3.2 Mechanical Installation.....	22
3.2.1 Wall Installation.....	22
3.2.2 Pipe Installation .....	24
3.2.3 Media Connection Installation .....	26
3.2.4 Installing the Retractable Fitting and Media Adapter Supply.....	27
3.2.5 Water Supply Installation .....	31
3.2.6 Compressed Air Supply Installation .....	32
3.2.7 Installing the Media Adapter with Metering Pumps and Containers.....	33
3.2.8 Industrial Transmitter Installation .....	33
3.2.9 Retractable Fitting Installation .....	33
3.3 Electrical Installation.....	34
3.3.1 Service Switch Electrical Installation .....	38
3.3.2 Media Adapter Electrical Installation .....	38
3.4 Process Control System Installation .....	39
<b>4 Commissioning</b> .....	<b>41</b>

<b>5</b>	<b>Parameter Setting .....</b>	<b>42</b>
5.1	Protos Parameter Setting .....	42
5.1.1	Calibration Timer .....	44
5.1.2	Time Control.....	45
5.1.3	Control and Service Programs .....	48
5.1.4	Configuring the Program Flow.....	60
5.1.5	Calibration.....	61
5.1.6	Installation .....	62
<b>6</b>	<b>Operation .....</b>	<b>67</b>
6.1	Metering Pump: Filling the Containers .....	67
6.2	Progress Display .....	69
<b>7</b>	<b>Diagnostics.....</b>	<b>71</b>
7.1	Protos Diagnostic Functions .....	71
7.2	Relay Contacts.....	72
<b>8</b>	<b>Maintenance .....</b>	<b>74</b>
8.1	Inspection and Maintenance .....	74
8.1.1	Protos Maintenance Functions.....	74
8.1.2	Pilot Valve Functional Test.....	78
8.2	Corrective Maintenance .....	79
8.2.1	Corrective Maintenance on the Metering Pumps .....	79
8.2.2	Replacing the Air Pressure Switch.....	81
8.2.3	Replacing the Water Pressure Switch.....	82
8.2.4	Knick Repair Service .....	82
<b>9</b>	<b>Troubleshooting .....</b>	<b>83</b>
9.1	Protos Malfunction Message .....	87
<b>10</b>	<b>Decommissioning .....</b>	<b>88</b>
10.1	Unical: Removal .....	88
10.2	Return.....	88
10.3	Disposal .....	88
<b>11</b>	<b>Spare Parts and Accessories .....</b>	<b>89</b>
11.1	Spare Parts.....	89
11.2	Accessories .....	93
<b>12</b>	<b>Dimension Drawings .....</b>	<b>95</b>
<b>13</b>	<b>Specifications.....</b>	<b>99</b>
<b>14</b>	<b>Annex.....</b>	<b>103</b>
14.1	Pneumatic Circuit Diagrams.....	103
14.2	Symbols and Markings on the Display .....	105
14.3	Overview of Unical Messages .....	108
	<b>Abbreviations .....</b>	<b>111</b>
	<b>Index.....</b>	<b>112</b>

# 1 Safety

This document contains important instructions for the use of the product. Always follow all instructions and operate the product with caution. If you have any questions, please contact Knick Elektronische Messgeräte GmbH & Co. KG (sometimes hereafter referred to as “Knick”) using the information provided on the back page of this document.

## 1.1 Intended Use

The Unical 9000 is an electro-pneumatic controller for fully automatic process control of pH measurements.

The sensor is immersed in the process medium (PROCESS limit position) by the retractable fitting’s probe (sensor housing or immersion tube). In the service position (SERVICE limit position), the sensor can be cleaned, calibrated, or replaced. The cleaning or calibration media are automatically supplied via the media connection and media adapter.

Unical 9000 can be used in combination with the following products:

Retractable fittings	SensoGate
	Ceramat
Industrial transmitter	Protos II 4400

Further information can be found in the relevant product documentation.

The defined operating conditions must be observed when using this product. → *Specifications, p. 99*

**USE CAUTION AT ALL TIMES WHEN INSTALLING, USING, MAINTAINING OR OTHERWISE INTERACTING WITH THE PRODUCT. ANY USE OF THE PRODUCT EXCEPT AS SET FORTH HEREIN IS PROHIBITED, AND MAY RESULT IN SERIOUS INJURY OR DEATH, AS WELL AS DAMAGE TO PROPERTY. THE OPERATING COMPANY SHALL BE SOLELY RESPONSIBLE FOR ANY DAMAGES RESULTING FROM OR ARISING OUT OF AN UNINTENDED USE OF THE PRODUCT.**

All references to “device,” “product,” “Unical 9000,” “Protos II 4400,” “MSU4400-180,” “COMPA3400-081” refer to the various versions, both non-Ex and Ex, of the relevant device.

The Unical 9000-X version is certified for operation in hazardous locations.

→ *Operation in Explosive Atmospheres, p. 7*

## 1.2 Personnel Requirements

The operating company shall ensure that any personnel using or otherwise interacting with the product is adequately trained and has been properly instructed.

The operating company shall comply and cause its personnel to comply with all applicable laws, regulations, codes, ordinances and relevant industry qualification standards related to product. Failure to comply with the foregoing shall constitute a violation of operating company’s obligations concerning the product, including but not limited to an unintended use as described in this document.

## 1.3 Safeguards

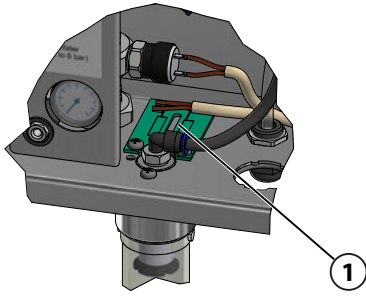

### Water Leakage Detection

There is a circuit board (1) on the base of the controller's housing. Its contact surfaces detect the presence of electrically conductive liquids on them. If, for example, water leaks out, a current flow generates the following error message in the industrial transmitter: Leakage Sensor (U224)

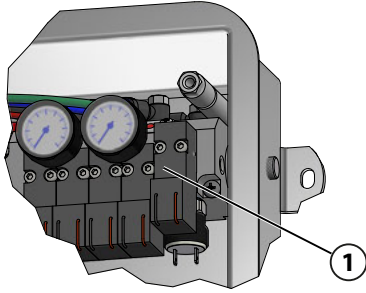

### Safety Valve

The safety valve (1) is connected upstream of all pilot valves. When you press the service switch, all pilot valves are depressurized by the safety valve.

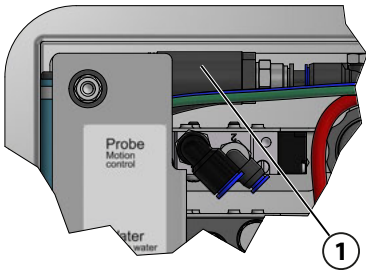

### Sensor dismount guard

The sensor dismount guard (1) measures the pressure drop or variations that can occur during operation of the retractable fitting.<sup>1)</sup> A pressure drop is a sign that there is no sensor in the retractable fitting. Movement of the retractable fitting to the process position (PROCESS limit position) is stopped. Message in the industrial transmitter: Immersion lock (U221)

## 1.4 Residual Risks

The product has been developed and manufactured in accordance with generally accepted safety rules and regulations, as well as an internal risk assessment. Despite the foregoing, the product may among others bear the following risks:

The effects of moisture, ambient temperature, chemicals, and corrosion can negatively impact the safe operation of the product. Observe the following instructions:

- Observe the permissible ambient temperature. Alternatively, use protective cabinets and heatable media connections. → *Specifications, p. 99*
- Protect the controller from direct sunlight.
- If using aggressive chemical process media, adhere to and adjust the inspection and maintenance intervals accordingly.

### Drinking Water Connection

If the Unical 9000 is connected to the drinking water supply, impurities caused by the rinse and process media may occur. Note the information in EN 1717. Install a suitable check valve at the water or rinse connection. → *Accessories, p. 93*

<sup>1)</sup> Applies only when using a Ceramat retractable fitting.

## 1.5 Hazardous Substances

**IN THE EVENT OF ANY CONTACT WITH HAZARDOUS SUBSTANCES OR OTHER INJURY HEREUNDER, SEEK IMMEDIATE MEDICAL ATTENTION OR FOLLOW APPLICABLE PROCEDURES TO ADDRESS HEALTH AND SAFETY OF PERSONNEL. FAILURE TO SEEK IMMEDIATE MEDICAL ATTENTION MAY RESULT IN SERIOUS INJURY OR DEATH.**

In certain situations (e.g., sensor replacement or corrective maintenance), personnel may come into contact with the following hazardous substances:

- Process medium
- Cleaning medium
- Buffer and calibration solutions

The operating company is responsible for conducting a risk assessment.

See the relevant manufacturers' safety datasheets for hazard and safety instructions on handling hazardous substances.

## 1.6 Operation in Explosive Atmospheres

The Unical 9000-X is certified for operation in hazardous locations.

- EU-Type Examination Certificate KEMA 04ATEX1036
- IECEx Certificate of Conformity IECEx DEK 22.0022

The conditions for installation and operation in explosive atmospheres can be found on the corresponding certificates.

Observe all applicable local and national codes and standards for the installation of electrical equipment in explosive atmospheres. For further guidance, consult the following:

- IEC 60079-14
- EU directives 2014/34/EU and 1999/92/EC (ATEX)

Modules which have already been used shall be subjected to a professional routine test before they may be operated in another type of protection.

- Before the product is commissioned, the operator must provide proof that the product is approved for connection to other equipment (including cables and wires). Connecting components designed for explosive atmospheres and those not designed for explosive atmospheres (mixed equipping) is not permitted.

### Unical 9000-X Markings

Information on the Unical 9000-X markings is available in the enclosed certificates.

### Electrostatic Discharge

Some materials used in the product are electrostatic insulators and may be electrostatically charged. To prevent electrostatic discharge, please observe the following instructions:

- Clean non-metallic components with a damp cloth only, and allow them to dry.

### Certificates

The current versions of the applicable certificates are available at [www.knick.de](http://www.knick.de).

## 1.7 Operation and Installation

All national and local regulations relating to the installation and operation of the product in force at the destination must be followed.

## **1.8 Maintenance and Spare Parts**

### **Preventive Maintenance**

Preventive maintenance can keep the product in good condition and minimize downtimes. Knick provides recommended inspection and maintenance intervals. → *Maintenance, p. 74*

### **Spare Parts**

For professional corrective maintenance of the product, only use Knick genuine spare parts. Usage of any other spare parts shall constitute an unintended use of the product.

### **Repair Service**

The Knick Repair Service offers professional corrective maintenance for the product to the original quality. Upon request, a replacement unit can be obtained for the period of the repair.

Further information can be found at [www.knick.de](http://www.knick.de).

## **1.9 Safety Training**

Upon request, Knick Elektronische Messgeräte GmbH & Co. KG will provide safety briefings and product training during initial commissioning of the product. More information is available from the relevant local contacts.



## 2 Product

### 2.1 Package Contents

- Unical 9000 in the version ordered
- Service switch
- 2 identical cables (to connect Unical 9000 to the service switch and Unical 9000 to the Protos industrial transmitter)
- Cable with plug (to connect Unical 9000 to the media adapter)
- Hook wrench
- User Manual
- EU Declaration of Conformity<sup>1)</sup>
- Control Drawing<sup>1)</sup>
- Test Report 2.2 according to EN 10204

### 2.2 Product Identification

The different versions of the Unical 9000 are encoded in a model designation.

The model designation is stated on the nameplate, the delivery note, and the product packaging.

→ Nameplates, p. 11

#### 2.2.1 Example of a Version

Unical		9000	-	X	S	G	1	A	2	2	2	C	E	-	4	0	0
Explosion protection	For hazardous area Zone 1			X										-			
Housing	Stainless steel, polished				S									-			
Media connection (calibration and rinse function)	14 m (seal: EPDM)					G								-			
Media interface	Without						0							-			
Media adapter with port I-III	With (seal: EPDM)							A						-			
Port I	Metering pump with 3-liter container (EPDM)								2					-			
Port II	Metering pump with 3-liter container (EPDM)									2				-			
Port III	Metering pump with 3-liter container (EPDM)										2			-			
Supplementary air purging Aux 1	With											C		-			
Supplementary external valve Aux 2	With												E	-			
Special version	With protective cabinet and heater, Ex													-	4	0	0

<sup>1)</sup> Part of package contents only for Ex-approved products

## 2.2.2 Product Code

Unical	9000	-	-	-	-	-	-	-	-	-	-	-	-	-	-	-	-	-				
Explosion protection	For hazardous area Zone 1																		X			
	Without																		N			
Housing	Steel, coated																		C			
	Stainless steel, polished																		S			
Media connection (rinse function only)	5 m (seal: FKM)																		1	0		
	10 m (seal: FKM)																		2	0		
	15 m (seal: FKM)																		5	0		
	5 m (seal: EPDM)																		A	0		
	10 m (seal: EPDM)																		B	0		
	15 m (seal: EPDM)																		E	0		
Media connection (calibration and rinse function)	5 m (seal: FKM)																		3			
	10 m (seal: FKM)																		4			
	14 m (seal: FKM)																		7			
	17 m (seal: FKM)																		6			
	5 m (seal: EPDM)																		C			
	10 m (seal: EPDM)																		D			
	14 m (seal: EPDM)																		G			
	17 m (seal: EPDM)																		F			
Media interface	With <sup>1)</sup>																		1			
	Without <sup>2)</sup>																		0			
Media adapter with port I-III	With (seal: FKM)																		1			
	With (seal: EPDM)																		A			
	Without																		0			
Port I	Metering pump with 3-liter container (EPDM)																		2			
	Without																		0			
Port II	Metering pump with 3-liter container (EPDM)																		2			
	Without																		0			
Port III	Metering pump with 3-liter container (EPDM)																		2			
	Metering pump with 3-liter container (FKM)																		B			
	Without																		0			
Supplementary air purging Aux 1	With																		C			
	Without																		N			
Supplementary external valve Aux 2	With																		E			
	Without																		N			
Special version	Without																			0	0	0
	With protective cabinet, non-Ex																			1	0	0
	With protective cabinet and heater, non-Ex																			2	0	0
	With protective cabinet, Ex																			3	0	0
	With protective cabinet and heater, Ex																			4	0	0

<sup>1)</sup> Interface for connecting retractable fittings from other manufacturers

<sup>2)</sup> For retractable fittings WA130, WA130H, WA132, WA150, WA153, WA154, WA155, or WA160

### 2.3 Nameplates

The Unical 9000 electro-pneumatic controller is identified by a nameplate on the outside of the right housing panel.

#### Unical Nameplate, Without ATEX Approval

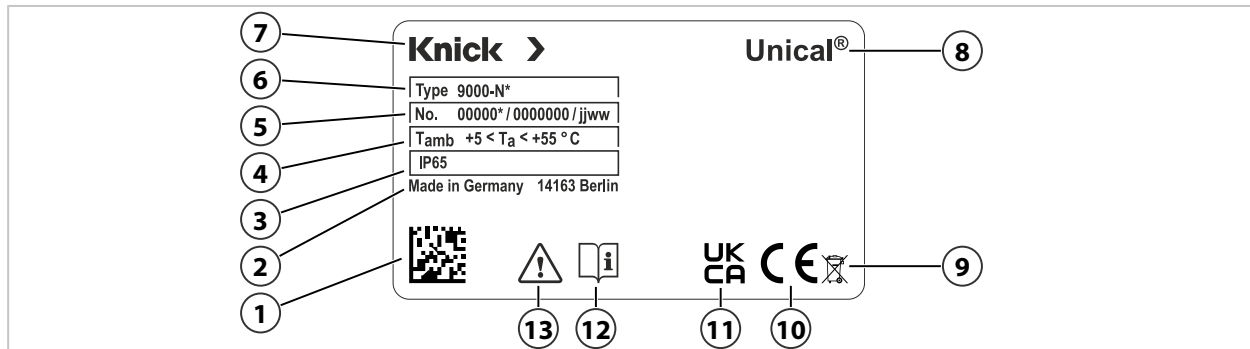

1	Data matrix code with item number and serial number	8	Product family
2	Manufacturer's address with designation of origin	9	WEEE mark
3	IP degree of protection	10	CE mark
4	Permissible ambient temperature	11	UKCA mark
5	Item number/serial number/production year and week yyww	12	Reference to product documentation
6	Model designation	13	Special conditions and danger points
7	Manufacturer		

#### Accessories Nameplate, Without ATEX Approval

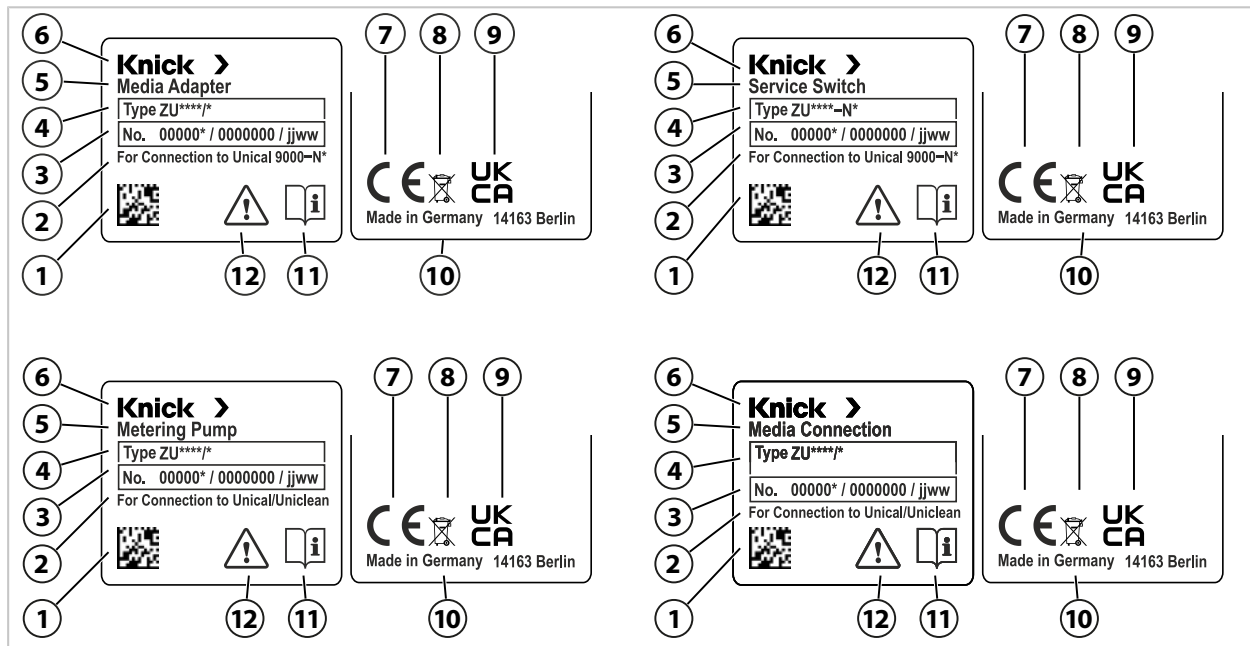

1	Data matrix code with item number and serial number	7	CE mark
2	Note	8	WEEE mark
3	Item number/serial number/production year and week yyww	9	UKCA mark
4	Model designation	10	Manufacturer's address with designation of origin
5	Product family	11	Reference to product documentation
6	Manufacturer	12	Special conditions and danger points

### Unical Nameplate, With ATEX Approval

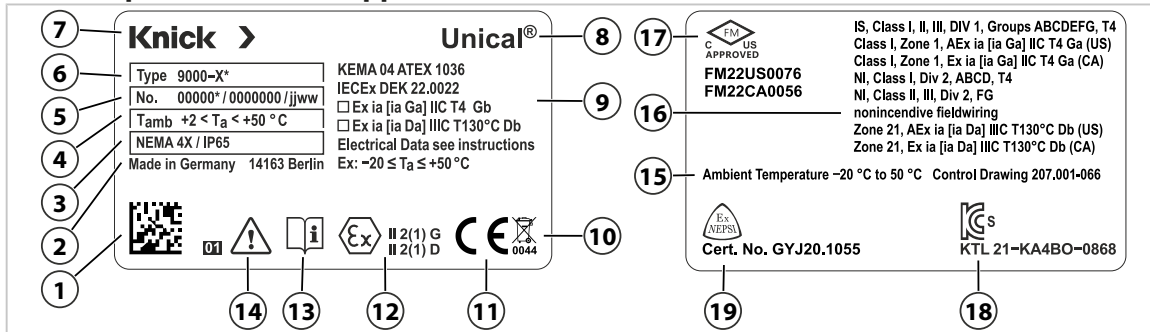





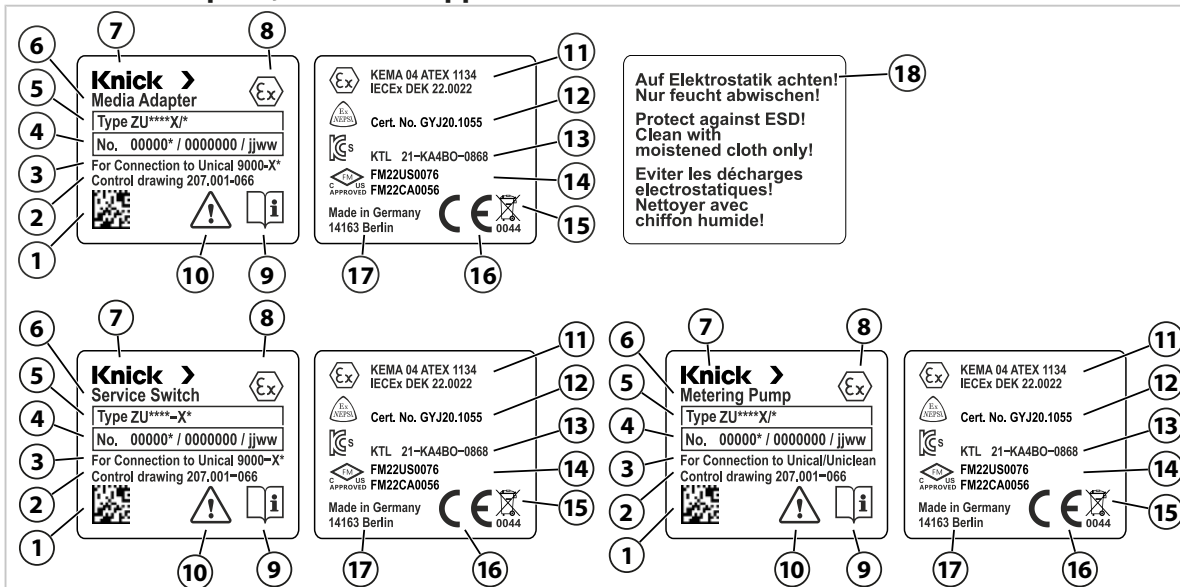



1 Data matrix code with item number and serial number	11 CE mark with identification number
2 Manufacturer's address with designation of origin	12 ATEX mark
3 Housing degree of protection	13 Reference to product documentation
4 Permissible ambient temperature (operation)	14 Special conditions and danger points
5 Item number/serial number/production year and week yyww	15 Permissible ambient temperature (explosion protection) and Control Drawing number
6 Model designation	16 Information on explosion protection
7 Manufacturer	17 FM mark
8 Product family	18 KCs mark
9 ATEX and IECEx mark, information on explosion protection	19 NEPSI mark
10 WEEE mark	

### Accessories Nameplate, With ATEX Approval



1 Data matrix code with item number and serial number	10 Special conditions and danger points
2 Control Drawing number	11 ATEX and IECEx mark
3 Note	12 NEPSI mark
4 Item number/serial number/production year and week yyww	13 KCs mark
5 Model designation	14 FM mark
6 Product family	15 WEEE mark
7 Manufacturer	16 CE mark with identification number
8 ATEX mark	17 Manufacturer's address with designation of origin
9 Reference to product documentation	18 Note

## 2.4 Symbols and Markings on the Product

	Special conditions and danger points! Observe the safety information and instructions on safe use of the product as outlined in the product documentation.
	Reminder to read the documentation
	CE mark with identification number <sup>1)</sup> of the notified body involved in production control
	ATEX marking <sup>1)</sup> of the European Union for operation of Unical 9000-X in hazardous locations → <i>Operation in Explosive Atmospheres, p. 7</i>
	UK Conformity Assessed: Conformity mark for the United Kingdom (England, Scotland, and Wales)
	KCs approval for Korea
	Mark of the Chinese organization NEPSI for operation in hazardous locations
	FM approval for US and Canada
	The symbol on Knick products means that the waste devices must be disposed of separately from unsorted municipal waste.

<sup>1)</sup> Dependent on the ordered version → *Product Code, p. 10*

## 2.5 Process Analysis System Design

The figure shows an example installation of a Knick process analysis system.

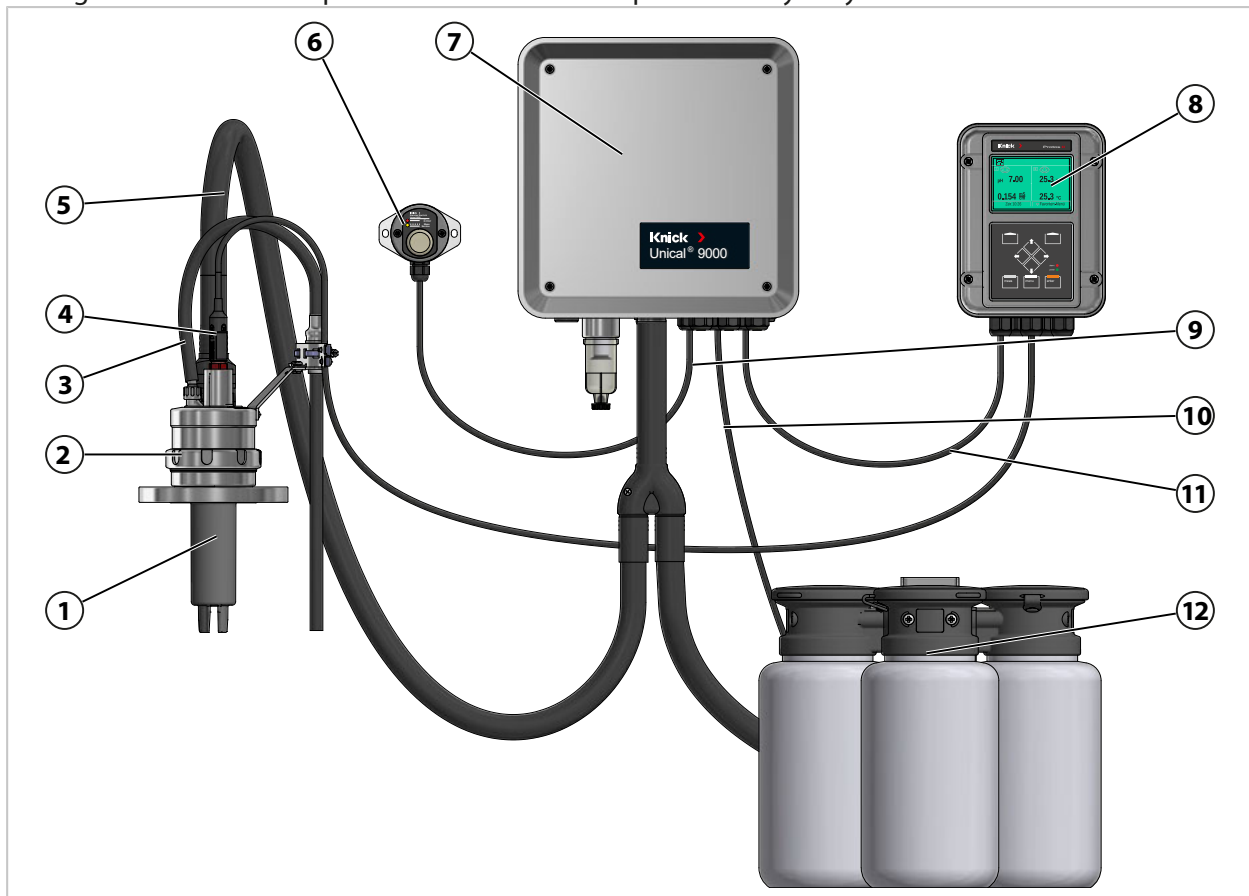

1	Probe (sensor housing/immersion tube) <sup>1)</sup>	7	Electro-pneumatic controller
2	Retractable fitting <sup>1)</sup>	8	Protos industrial transmitter <sup>1)</sup>
3	Retractable fitting: Outlet hose <sup>1)</sup>	9	Cable (to connect Unical 9000 to the service switch)
4	Sensor cable <sup>1)</sup>	10	Cable (to connect Unical 9000 to the media adapter)
5	Media connection	11	Cable (to connect Unical 9000 to the Protos industrial transmitter)
6	Service switch	12	Media adapter with metering pumps and container

<sup>1)</sup> Not included in the package contents.

### 2.5.1 Electro-Pneumatic Controller Design and Function

The electro-pneumatic controller controls the movements of the probe (sensor housing/immersion tube) into the process and service positions and the calibration and cleaning media supply lines.

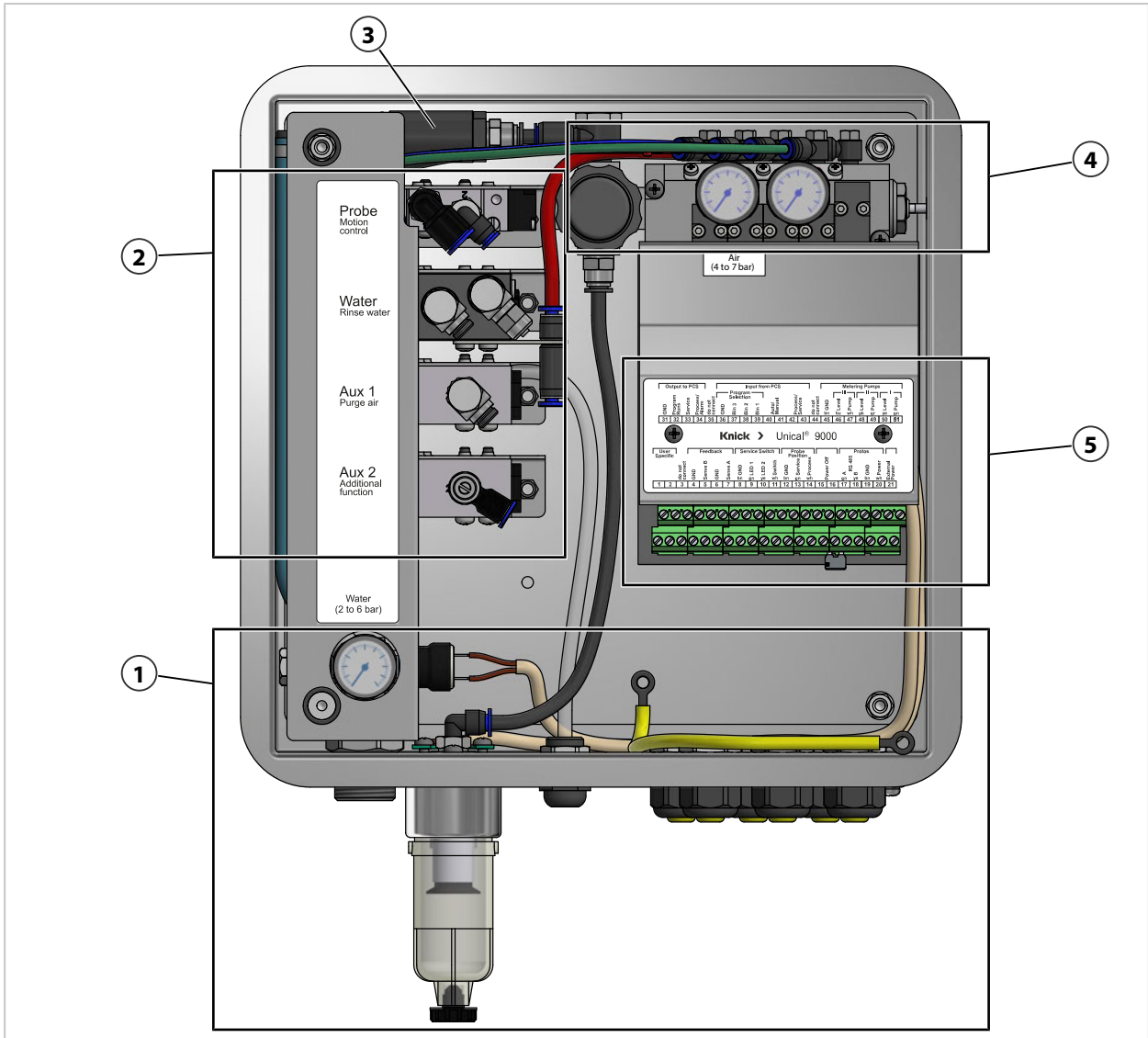

- |  |  |
|--|--|
| <ul style="list-style-type: none"> <li><b>1</b> Media supply</li> <li><b>2</b> Retractable fitting and media adapter supply</li> <li><b>3</b> Sensor dismount guard</li> </ul> | <ul style="list-style-type: none"> <li><b>4</b> Valve block</li> <li><b>5</b> Terminals</li> </ul> |
|--|--|

**Media Supply**

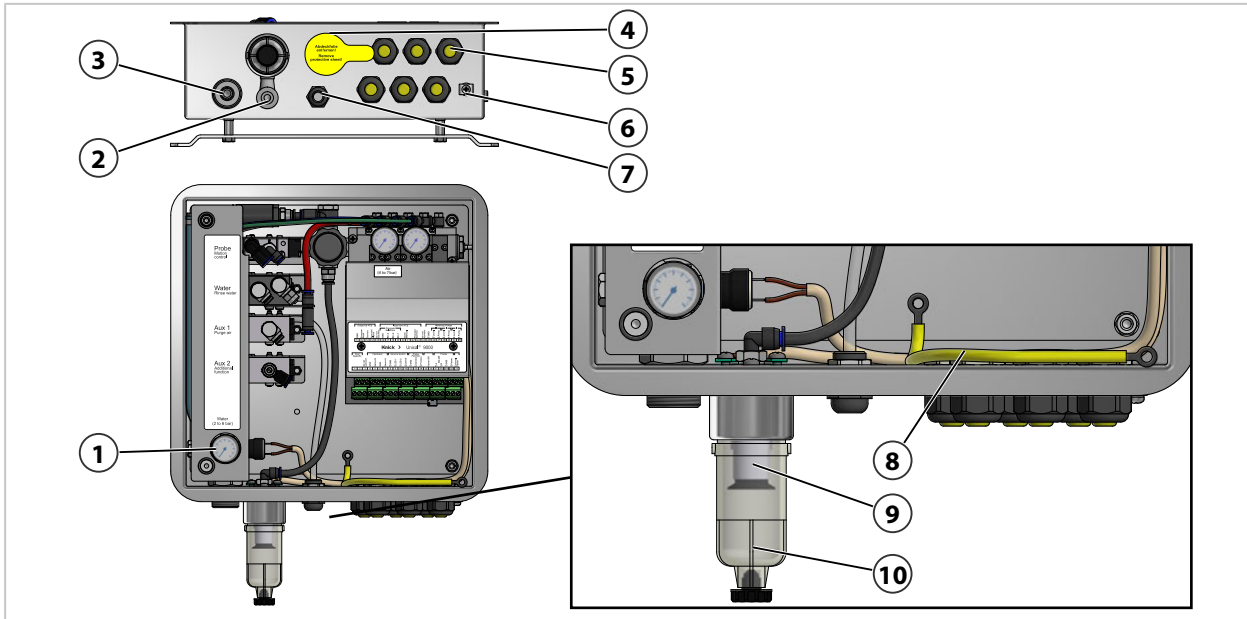

- |                                    |  |
|------------------------------------|--|
| 1 Water pressure manometer         | 6 Grounding connection                         |
| 2 Compressed air connection        | 7 Exhaust air tube (Aux 1)                     |
| 3 Water connection                 | 8 Housing with top piece equipotential bonding |
| 4 Feedthrough for media connection | 9 Compressed air filter                        |
| 5 Cable gland (6x)                 | 10 Water separator                             |

**Retractable Fitting and Media Adapter Supply**

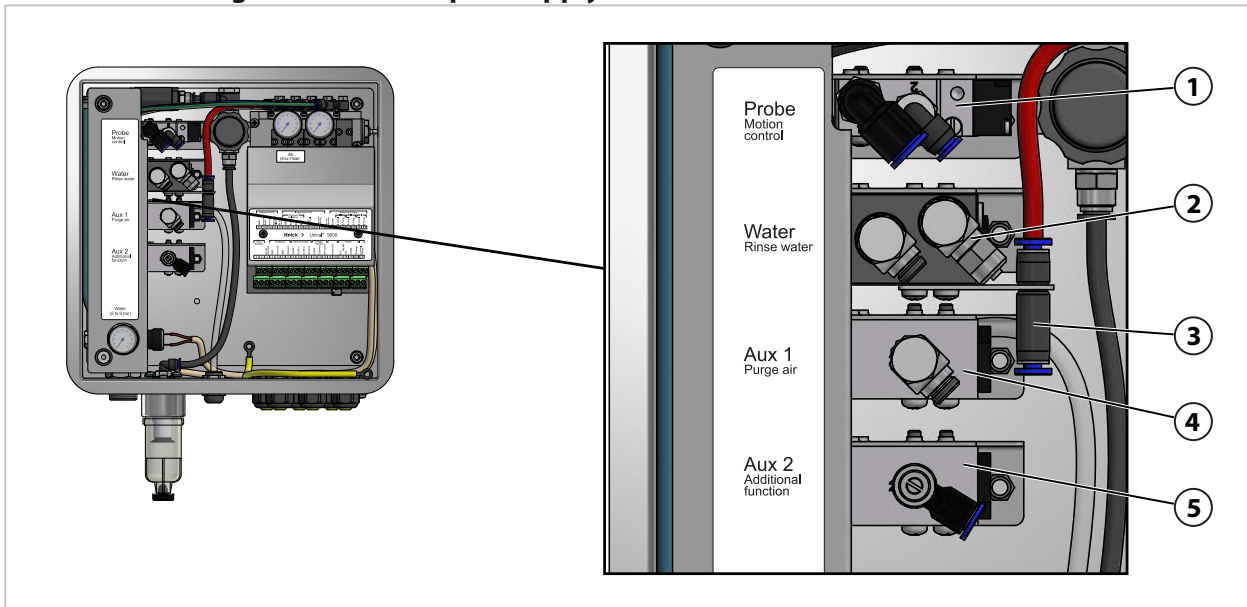

- |  |   |
|--|---|
| 1 Compressed air for the process and service positions | 4 Option Aux 1: <sup>1)</sup> compressed air for cleaning and rinsing |
| 2 Water for cleaning and rinsing                       | 5 Option Aux 2: <sup>1)</sup> compressed air for various applications |
| 3 Compressed air for media adapter                     |   |

<sup>1)</sup> Availability dependent on the ordered version → *Product Code, p. 10*





### 2.5.2 Media Adapter with Metering Pumps and Containers Design and Function

The media adapter with metering pumps and containers stores the calibration and cleaning media. These media are supplied to the retractable fitting via the metering pumps and the media connection.

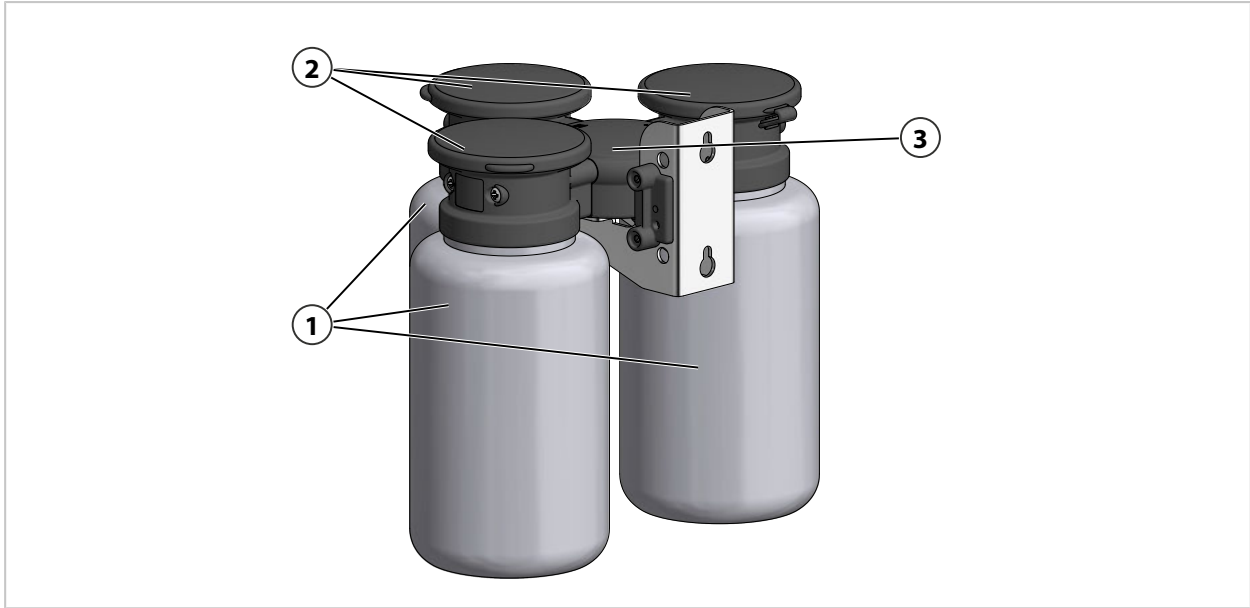

<p>1 Container</p> <p>2 Metering pumps</p>	<p>3 Media adapter</p>
--	------------------------

#### Media Adapter

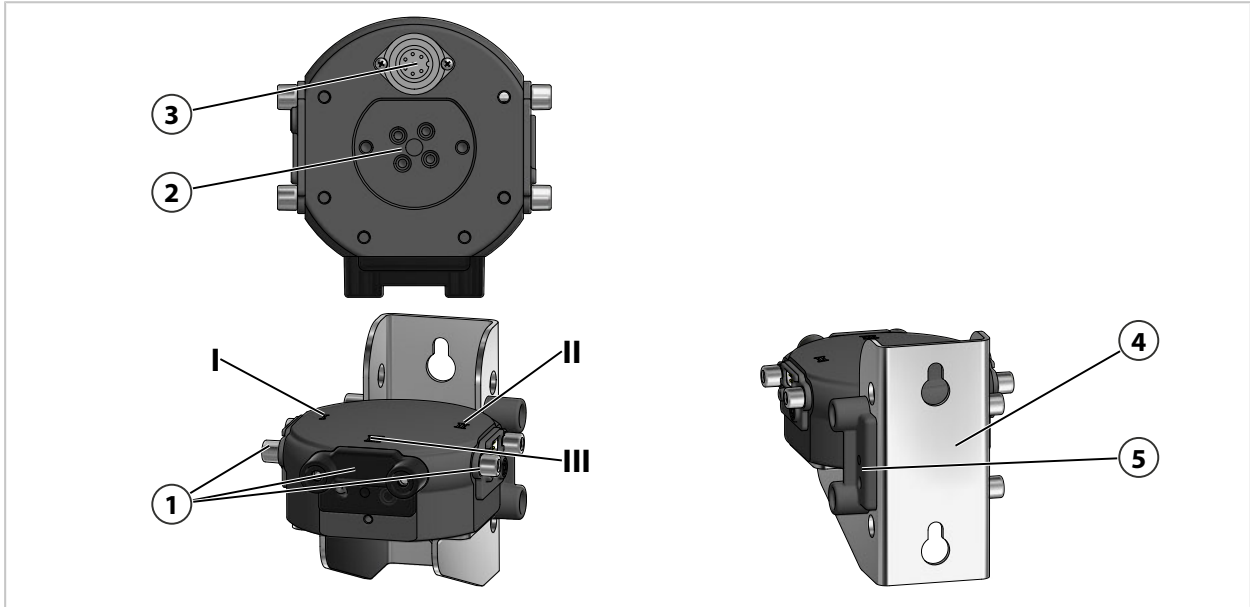

<p>1 Ports I to III</p> <p>2 Media connection</p> <p>3 Unical electro-pneumatic controller connection</p>	<p>4 Wall holder</p> <p>5 Blind plate holder</p>
---	--

**Metering Pump with Container**

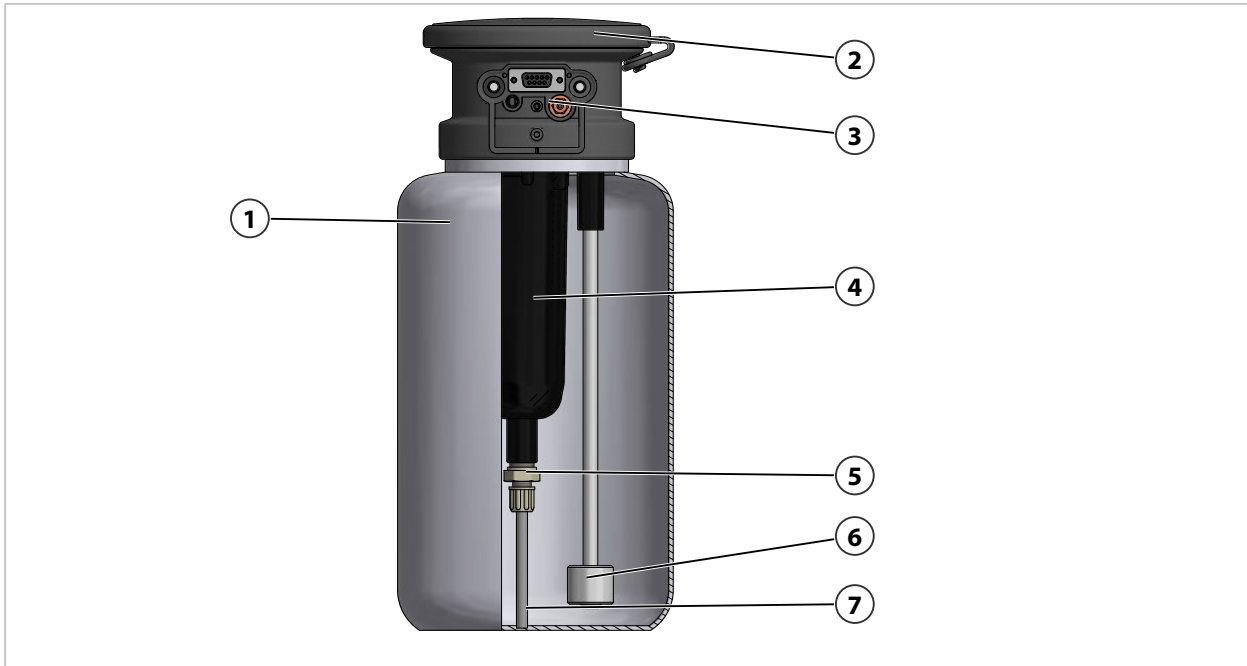

1 Container (approx. capacity 3 l)	5 Check valve
2 Top piece with funnel tube	6 Float switch
3 Media adapter connection	7 Suction tube
4 Pump housing	

**2.5.3 Service Switch Design and Function**

The service switch supplies the signal to move the probe (sensor housing/immersion tube) to the service position (SERVICE limit position). The system enters service mode. → *Service Mode, p. 74*

The service switch must be pressed again to exit service mode.

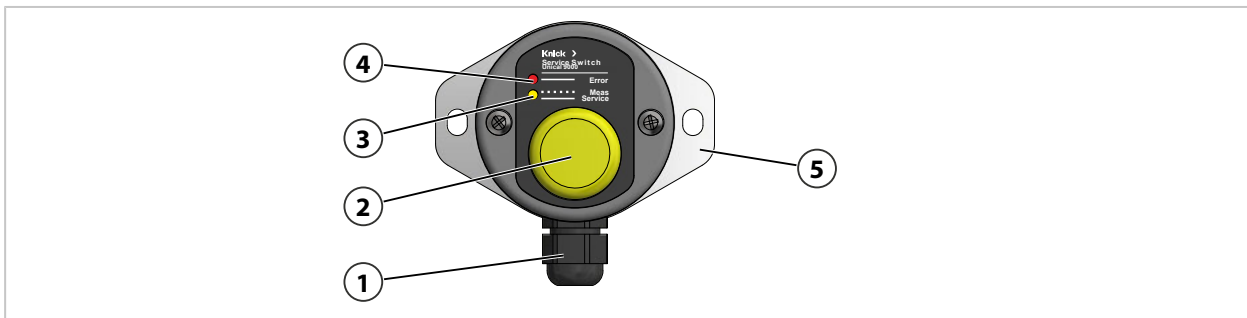

1 Cable gland	4 Error LED (red)
2 Switch	5 Wall holder
3 Service LED (yellow)	

**LED Messages**

Error LED (Red)	Service LED (Yellow)	Status
	Blinking	Retractable fitting in PROCESS position. Service switch actuated.
	Lit up	Retractable fitting in SERVICE position, safety valve depressurizes pilot valves.
Lit up		SERVICE position not reached. → <i>Troubleshooting, p. 83</i>

### 2.5.4 Media Connection Design and Function

The media connection connects the Unical 9000 electro-pneumatic controller, the media adapter to metering pumps and the retractable fitting. The corrugated hose contains eight media hoses and one cable. Check valves in the multiplug minimize entrainment and prevent backmixing of the calibration media.

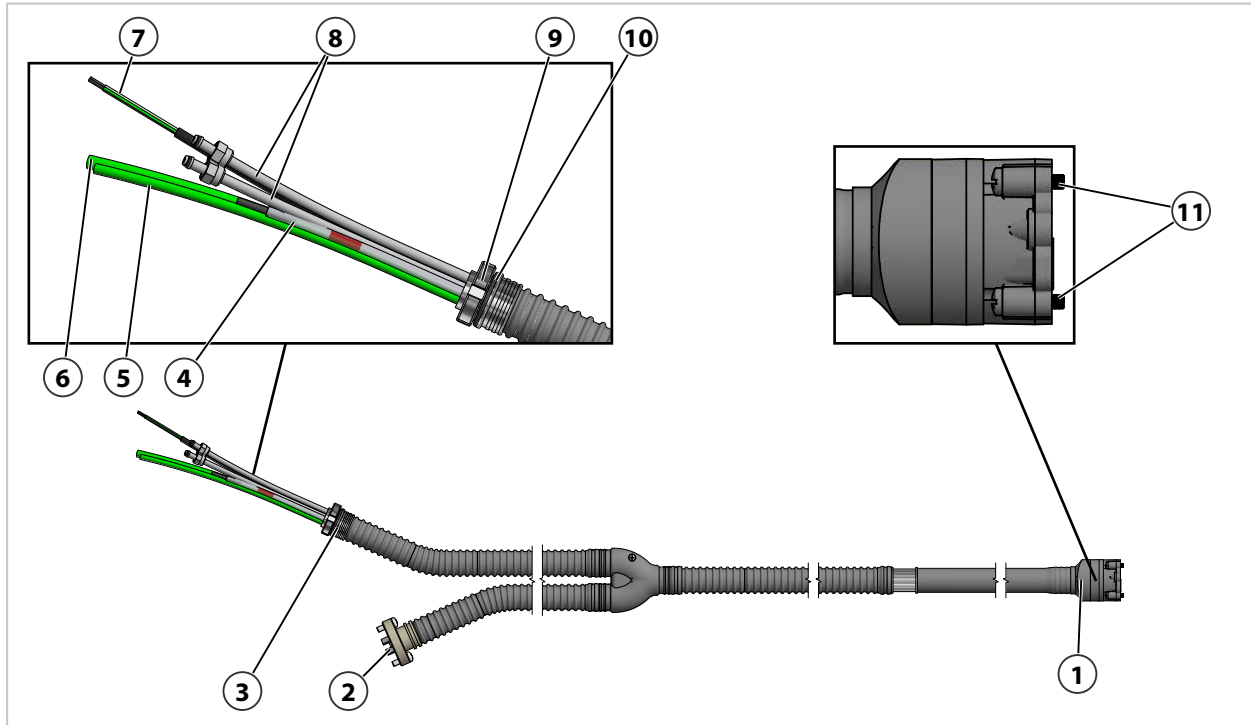

- |   |                                   |
|---|-----------------------------------|
| 1 Retractable fitting connection (multiplug)          | 7 Limit position check-back cable |
| 2 Media adapter with metering pumps connection        | 8 Water connection (transparent)  |
| 3 Unical 9000 electro-pneumatic controller connection | 9 Slotted nut                     |
| 4 Media adapter compressed air supply (red band)      | 10 O-ring 27 x 3 mm               |
| 5 Service position compressed air Ø 6 mm (green)      | 11 Fastening screws               |
| 6 Process position compressed air Ø 8 mm (green)      |                                   |

### 2.5.5 Changes for Different Conditions

The Unical 9000 can be adapted to changed conditions by the customer. Prior to making any changes, contact Knick Elektronische Messgeräte GmbH & Co. KG. The following are examples of possible changes:

- Installation of an additional air pressure valve

Any changes may result in deviations between the information on the nameplate and the actual version of the Unical 9000. The operating company must assess and document the changes. In the event of a change to the version, the product must be identified accordingly.

It is recommended that changes to the Unical 9000 be carried out by the Knick Repair Service. After making the necessary changes, a functional and pressure test is carried out and, if necessary, a modified nameplate is attached. → *Knick Repair Service, p. 82*

## 3 Installation

### 3.1 General Installation Instructions

- The Unical 9000 can be installed on a wall or pipe.
- The mounting location must have sufficient strength and be vibration-free.
- If installing outdoors, pay attention to the ambient temperature. → *Specifications, p. 99*  
Take protective measures if necessary.
- Install the service switch near the retractable fitting.

**Note:** All dimensions are given in millimeters [inches].

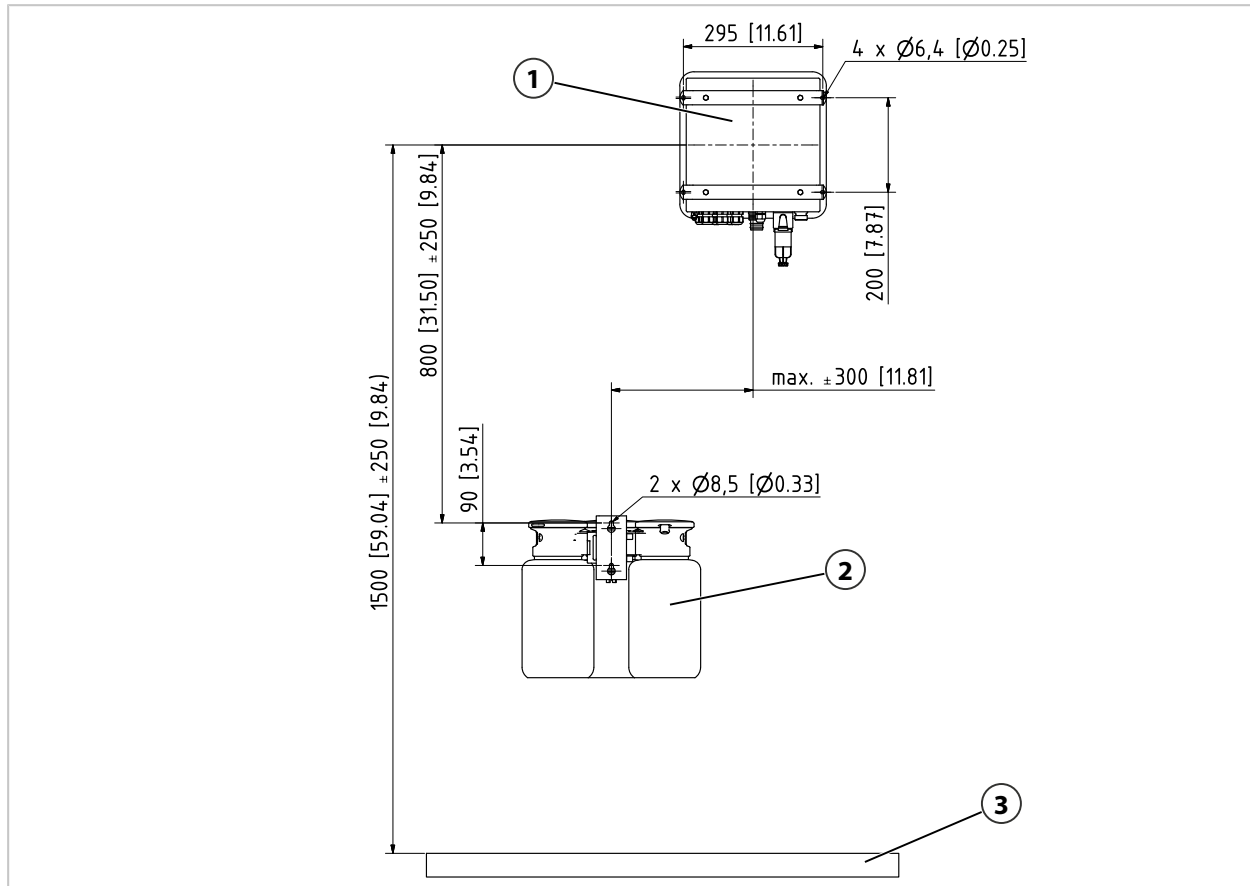

**1** Electro-pneumatic controller

**3** Floor

**2** Media adapter with metering pumps and containers

The distances are determined by the standard lengths of the cables.

The length of the standard media connection is measured as follows:

**Note:** All dimensions are given in millimeters [inches].

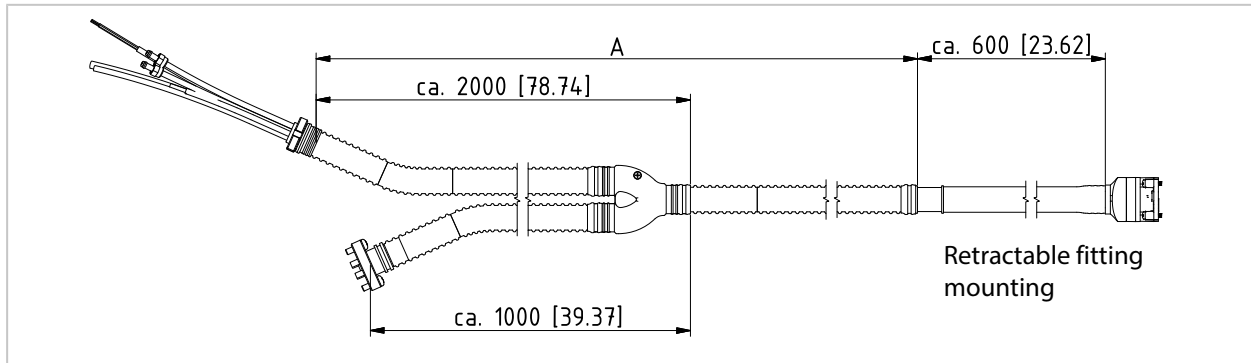

		Supplied Lengths
Cable (to connect Unical 9000 to the industrial transmitter)		Approx. 10 m
Cable (to connect Unical 9000 to the service switch)		Approx. 10 m
Unical 9000 with retractable fitting (media connection) <sup>1) 2)</sup>	Supplied length A:	Approx. 5 m Approx. 10 m Approx. 14 m Approx. 17 m

## 3.2 Mechanical Installation

### 3.2.1 Wall Installation

#### Electro-Pneumatic Controller

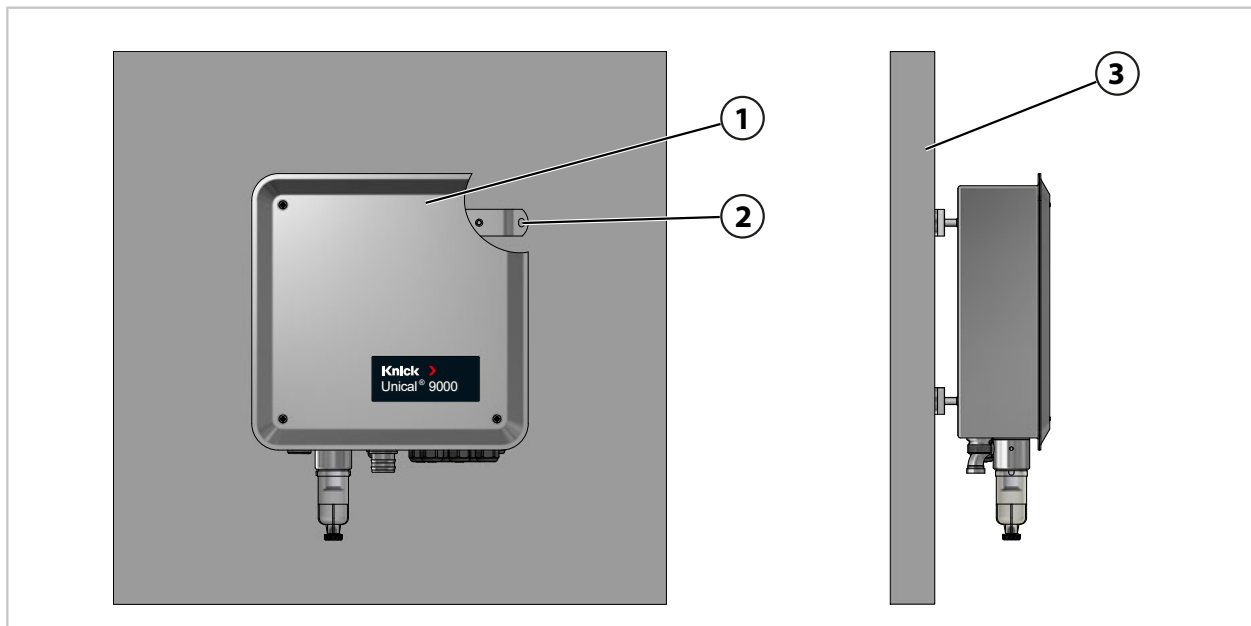

01. Check Unical 9000 **(1)** for damage.
02. Prepare the holes in accordance with the Dimension Drawing. → *Dimension Drawings, p. 95*
03. Fasten the Unical 9000 to the wall **(3)** with screws and washers<sup>3)</sup> in the four holes **(2)**.
04. Check for a tight fit.

<sup>1)</sup> Availability dependent on the ordered version → *Product Code, p. 10*

<sup>2)</sup> Other lengths on request

<sup>3)</sup> Not included in the package contents.

### Service Switch

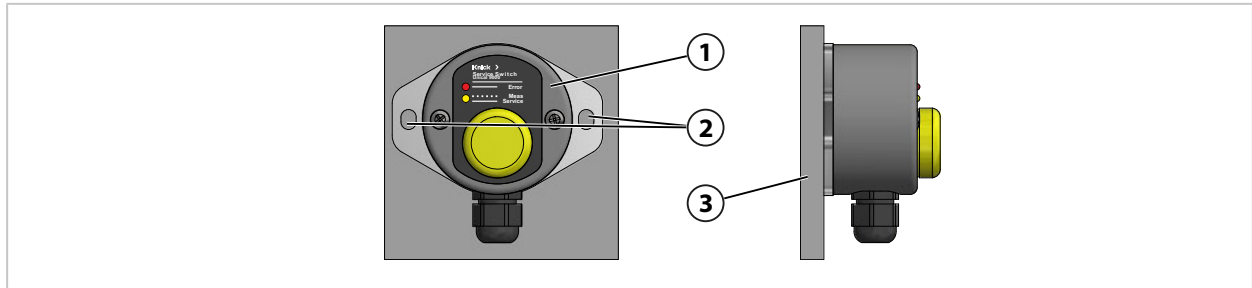

01. Check the service switch **(1)** for damage.
02. Prepare the holes in accordance with the Dimension Drawing. → *Dimension Drawings, p. 95*
03. Fasten the service switch to the wall **(3)** with screws and washers<sup>1)</sup> in the two holes **(2)**.
04. Check for a tight fit.

### Media Adapter with Metering Pumps and Containers

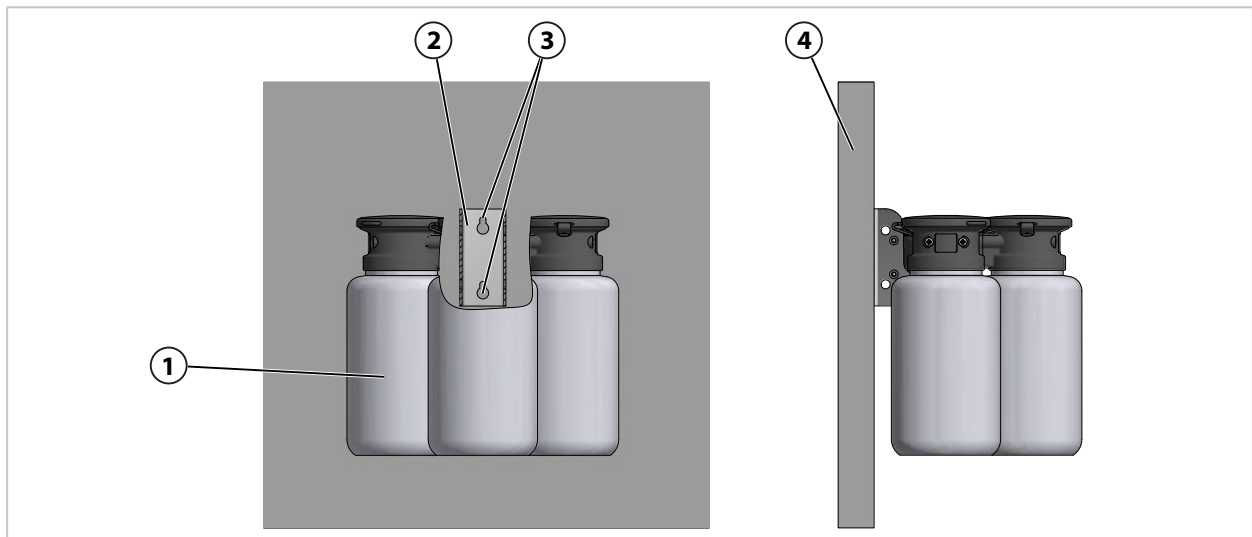

01. Check the media adapter with metering pumps and containers **(1)** for damage.
02. Prepare the holes in accordance with the Dimension Drawing. → *Dimension Drawings, p. 95*
03. Fasten the wall holder **(2)** to the wall **(5)** with screws and washers<sup>1)</sup> in the two holes **(3)**.
04. Check for a tight fit.

<sup>1)</sup> Not included in the package contents.

### 3.2.2 Pipe Installation

#### Unical 9000 Electro-Pneumatic Controller

**Note:** Accessories ZU0601 and ZU0606 are suitable for a pipe diameter of 30 ... 65 mm.

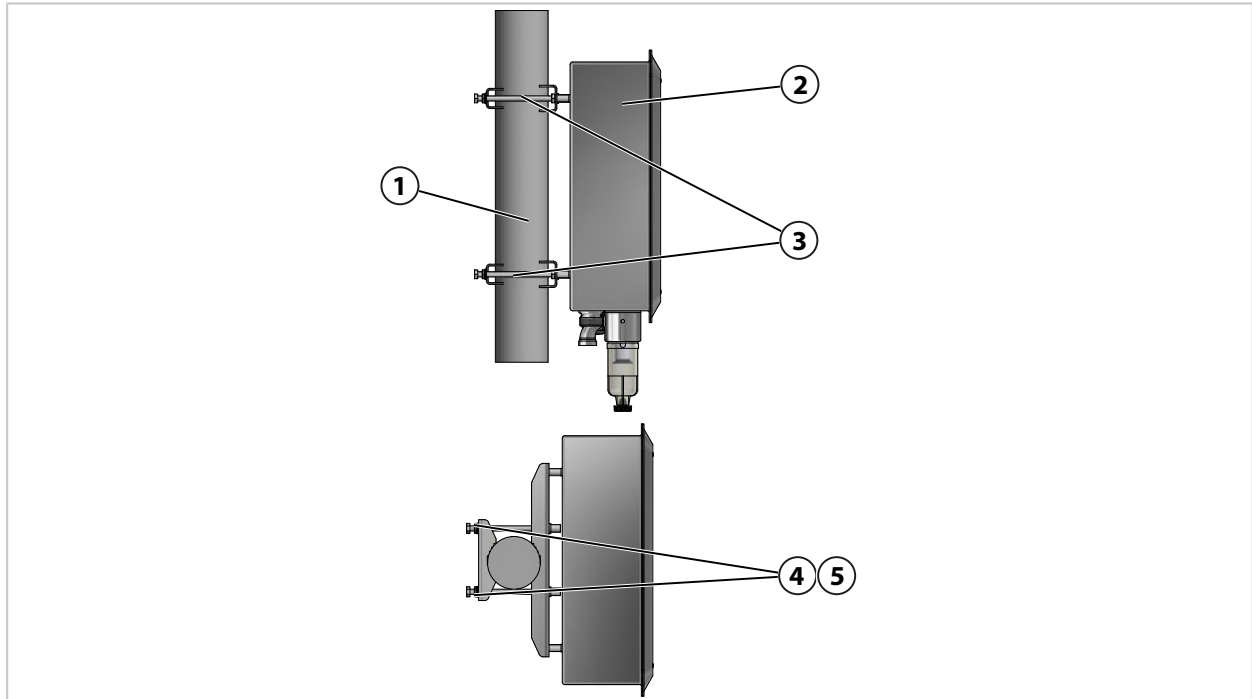

01. Check Unical 9000 **(2)** for damage.
02. Fasten the ZU0601 pipe-mount kit<sup>1)</sup> **(3)** to the rear of the housing.
03. Remove the screws **(4)** and washers **(5)** from the ZU0601 pipe-mount kit **(3)**.
04. Position the Unical 9000 on the pipe **(1)** and fasten with screws **(4)** and washers **(5)**.
05. Check for a tight fit.

<sup>1)</sup> Refer to the User Manual for the ZU0601 accessory.



## Service Switch

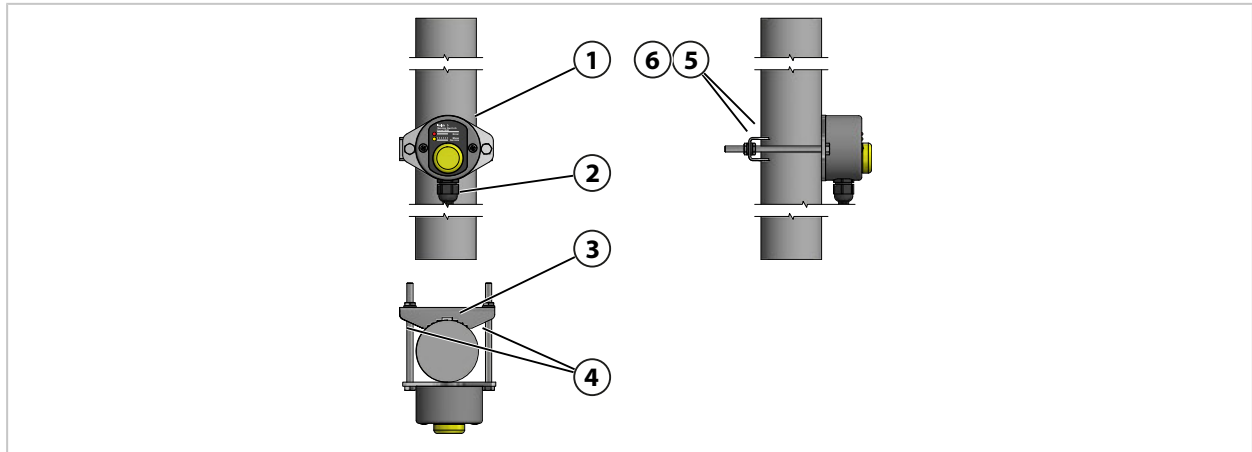

01. Check the service switch **(1)** for damage.
02. Fasten the pipe clamp **(3)** and screws **(4)** to the service switch **(1)**.
03. Remove the nuts **(5)** and washers **(6)**.
04. Position the service switch **(1)** on the pipe **(2)** and fasten with nuts **(5)** and washers **(6)**.
05. Check for a tight fit.

## Media Adapter with Metering Pumps and Containers

**Note:** Accessories ZU0601 and ZU0606 are suitable for a pipe diameter of 30 ... 65 mm.

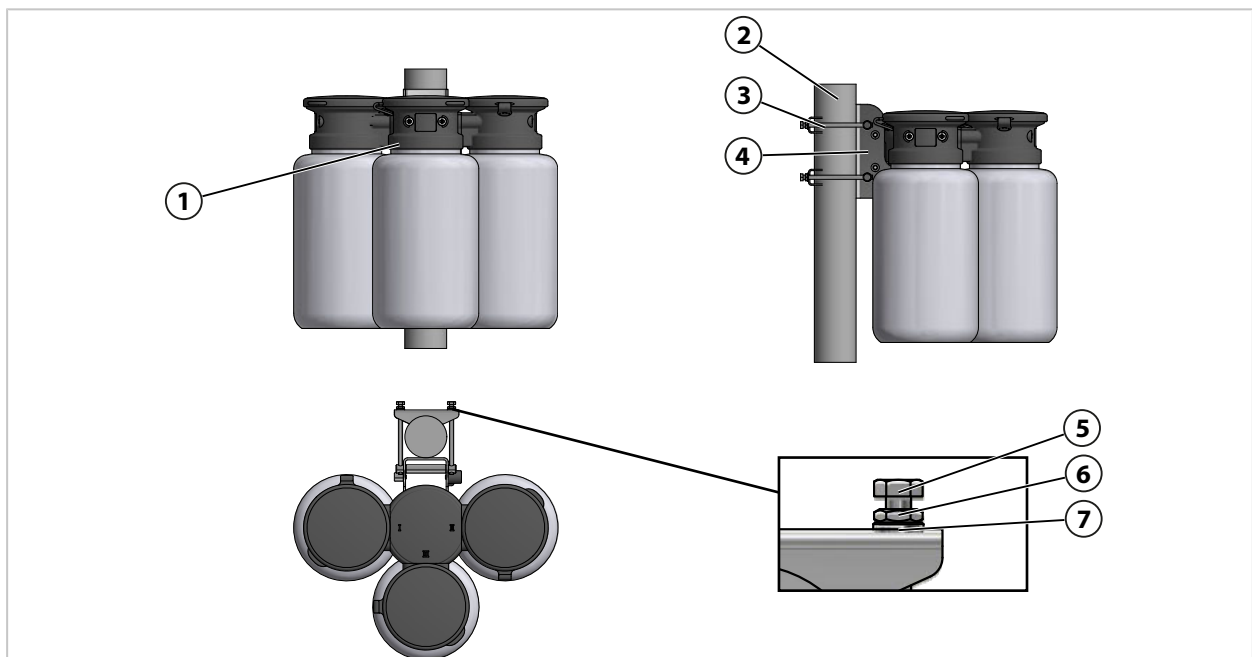

01. Check the media adapter with metering pumps and containers **(1)** for damage.
02. Fasten pipe-mount kit ZU0606<sup>1)</sup> **(3)** to the wall holder **(4)**.
03. Remove the cap nuts **(5)**, nuts **(6)**, and washers **(7)**.
04. Position pipe-mount kit ZU0606 **(3)** on the pipe **(2)** and fasten with cap nuts **(5)**, nuts **(6)**, and washers **(7)**.
05. Check for a tight fit.

<sup>1)</sup> Refer to the User Manual for the ZU0606 accessory.

### 3.2.3 Media Connection Installation

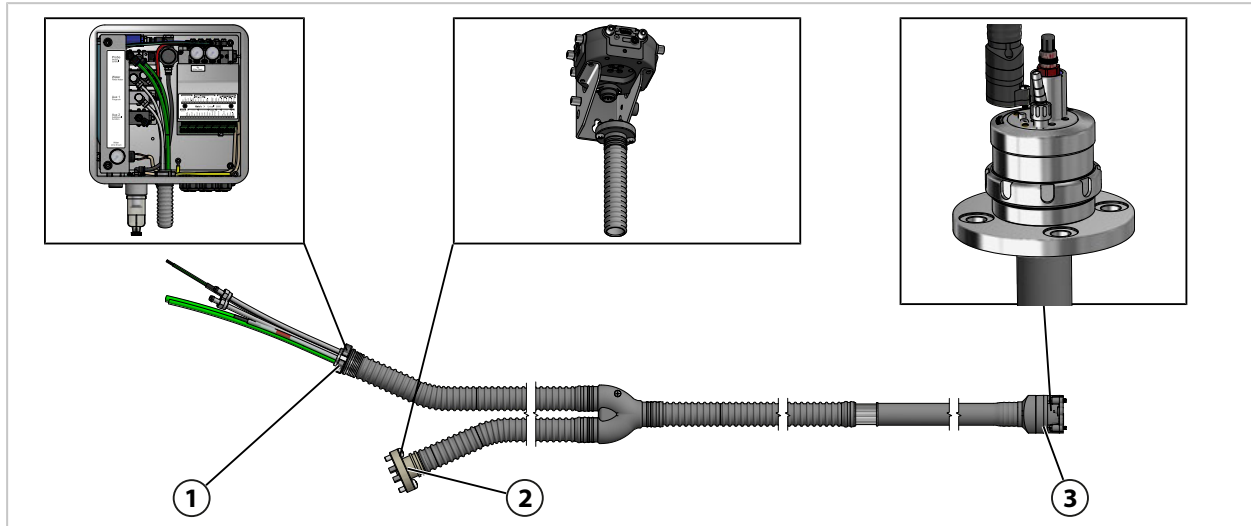

01. Fasten the media connection **(1)** to the Unical 9000.  
→ *Installing the Retractable Fitting and Media Adapter Supply, p. 27*
02. Fasten the media connection **(2)** to the media adapter with metering pumps.  
→ *Installing the Media Adapter with Metering Pumps and Containers, p. 33*  
**Note:** Information can be found in the retractable fitting User Manual.
03. Fasten the media connection **(3)** to the retractable fitting.

### 3.2.4 Installing the Retractable Fitting and Media Adapter Supply

#### Overview of Supply Connections:

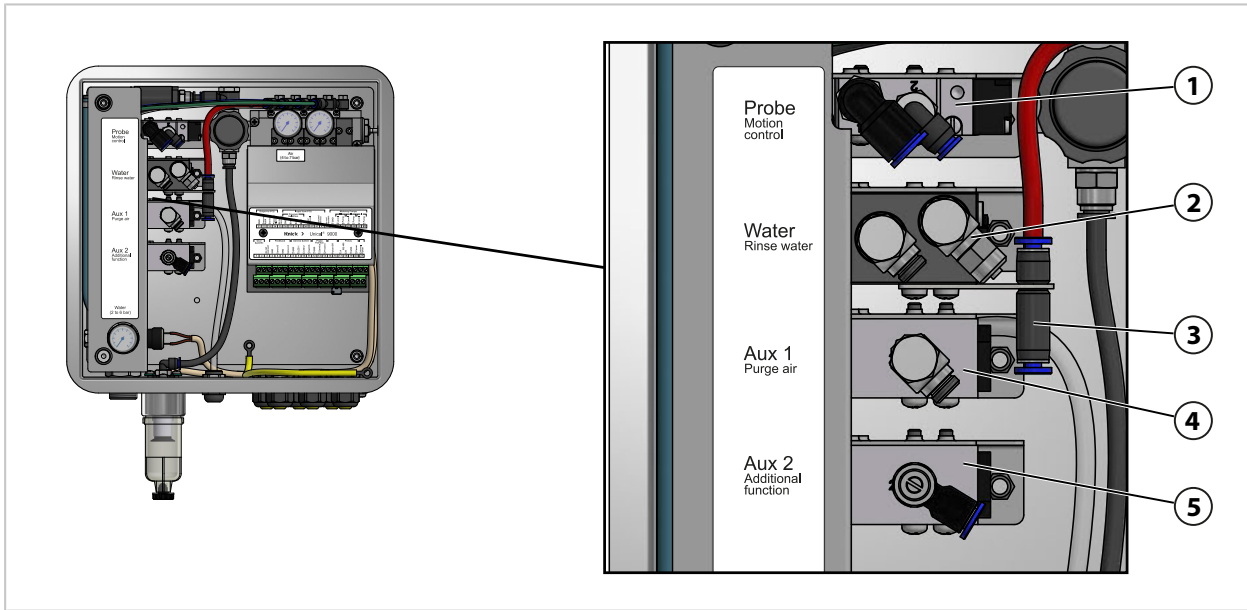

- |  |   |
|--|---|
| <p><b>1</b> Compressed air for the process and service positions</p> <p><b>2</b> Water for cleaning and rinsing</p> <p><b>3</b> Compressed Air for Media Adapter</p> | <p><b>4</b> Option Aux 1<sup>1)</sup>: compressed air for cleaning and rinsing</p> <p><b>5</b> Option Aux 2<sup>1)</sup>: compressed air for various applications</p> |
|--|---|

Control valve	Usage	Connection
Retractable fitting <b>(1)</b>	Compressed air moving to the process or service positions	Process position: Green hose Ø 8 Service position: Green hose DN 6
Water <b>(2)</b>	Cleaning and rinsing	Transparent hose DN 6
Compressed air <b>(3)</b>	Media adapter supply	Hose marked red Ø 6 mm with reduced conductor cross-section Ø 4 mm
Option: Air purging Aux 1 <b>(4)</b>	Cleaning and rinsing	Transparent hose DN 6
Option: Aux 2 <b>(5)</b>	Usage examples: <ul style="list-style-type: none"> <li>• Condensate drain for Ceramat WA160</li> <li>• Pressurization of pH sensors with liquid electrolyte</li> <li>• Actuation of external pumps (ZU0741 and ZU0741/1) → <i>Accessories, p. 93</i></li> <li>• Actuation of external customer valves (ZU0669) → <i>Accessories, p. 93</i></li> </ul>	Hose DN 6 <sup>2)</sup>

#### Factory Setting:

Water control valve:	One connection open, one connection closed
Control valves, air purging Aux 1 option:	Connection closed

<sup>1)</sup> Availability dependent on the ordered version → *Product Code, p. 10*

<sup>2)</sup> Not included in the package contents.

**Media Connection**

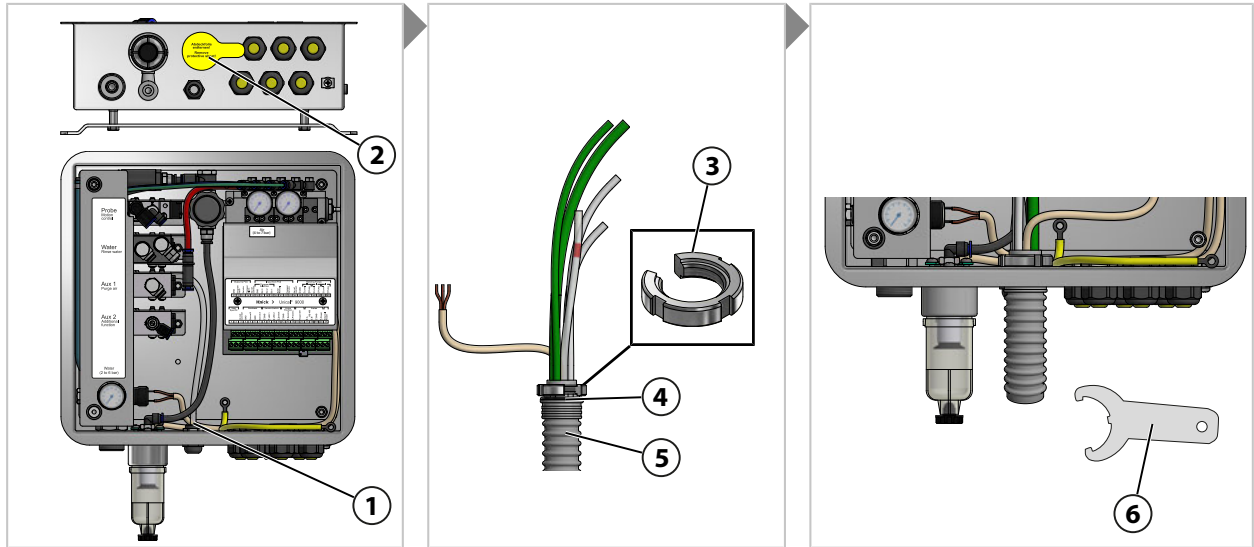

01. Remove the film **(2)**.
02. Unscrew the slotted nut **(3)** from the media connection **(5)**.
03. Guide the media connection hoses **(5)** through the opening **(1)**.
04. Check that the O-ring **(4)** is correctly seated.
05. Screw the slotted nut **(3)** from inside to the same position on the media connection **(5)**.
06. Tighten firmly with the hook wrench **(6)**.

**Compressed Air for Media Adapter**

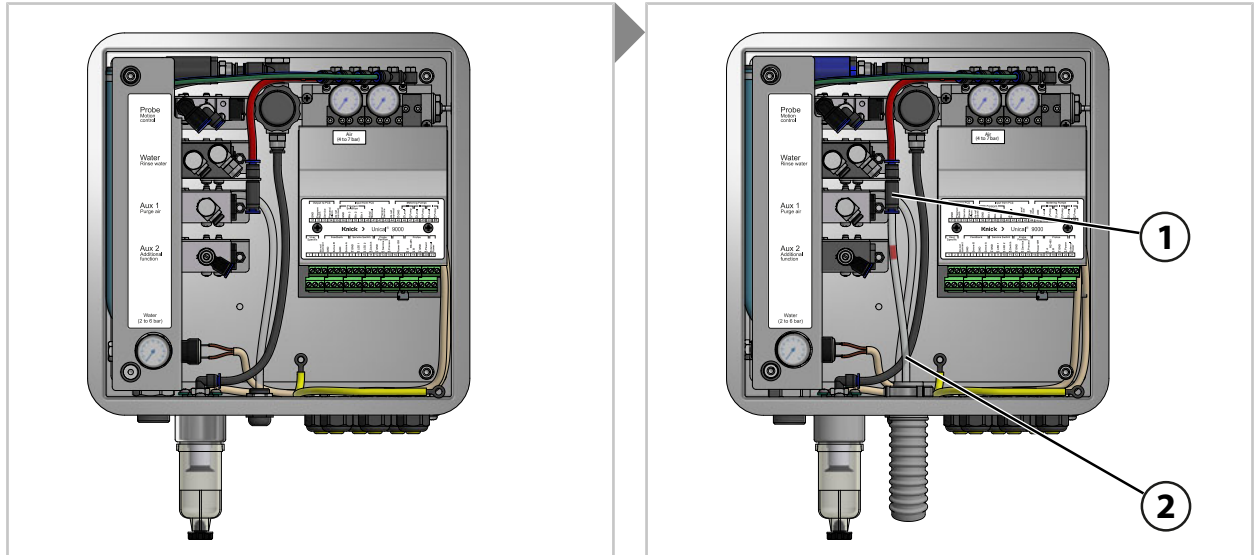

01. Push the compressed air hose marked red DN 6 **(2)** fully into the compressed air supply **(1)**.

**Water for Cleaning and Rinsing (Without Air Purging Aux 1 Option)**

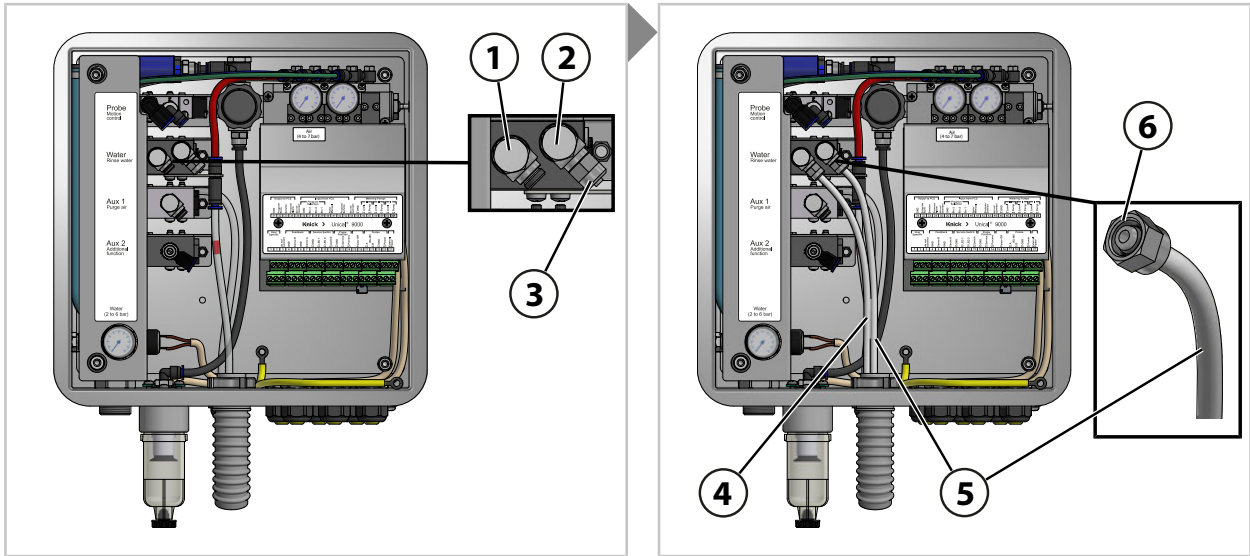

01. Remove the sealing cap **(3)** at the control valve **(2)**.
02. Push the transparent hose DN 6 **(5)** fully into the control valve **(2)** and fasten it with a coupling nut **(6)**.
03. Push the transparent hose DN 6 **(4)** fully into the control valve **(1)** and fasten it with a coupling nut **(6)**.

**Water for Cleaning and Rinsing (With Aux 1 Air Purging Option)**

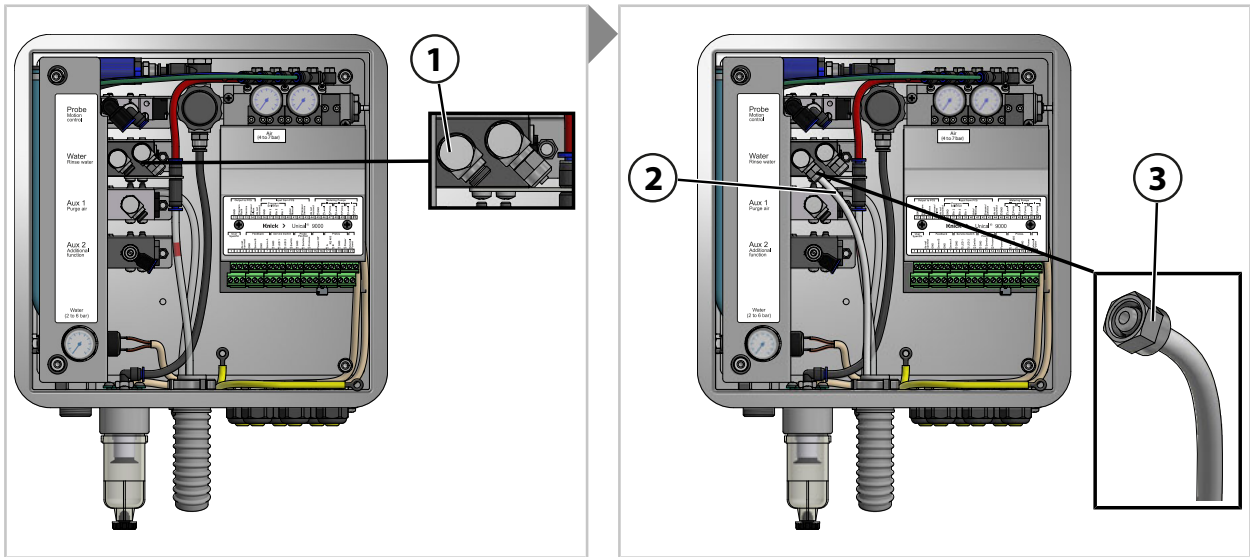

01. Push the transparent hose DN 6 **(3)** fully into the water control valve **(1)** and fasten it with a coupling nut **(5)**.

**Aux 1 Compressed Air for Cleaning and Rinsing Option**

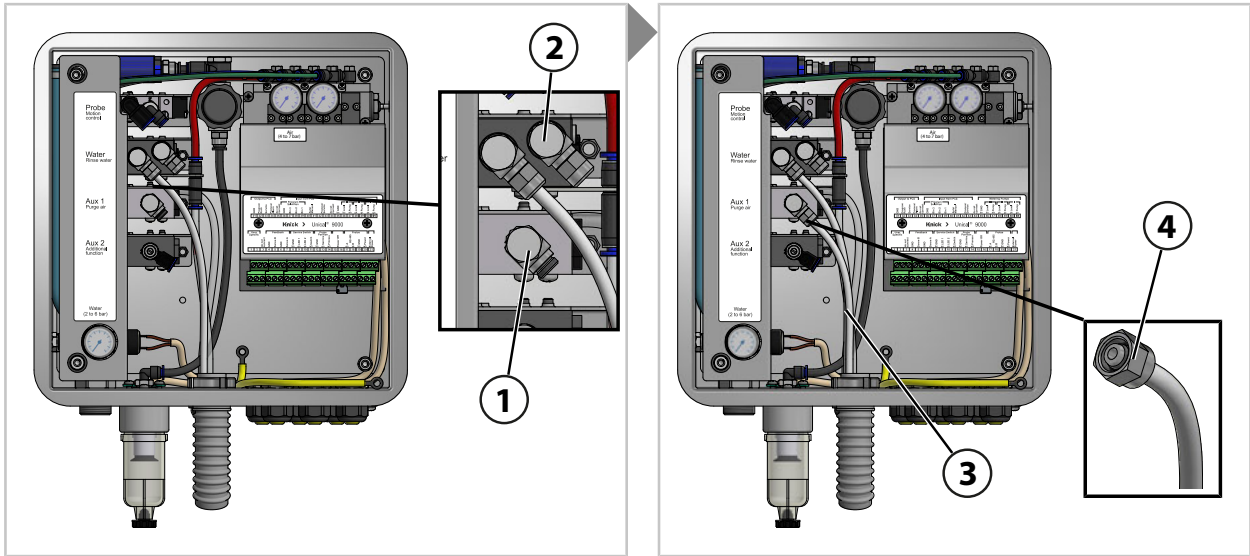

**Note:** If the Aux 1 option (compressed air for cleaning and rinsing) is used, the water control valve (2) remains closed.

01. Push the transparent hose DN 6 (3) fully into the Aux 1 control valve (1) and fasten it with a coupling nut (4).

**Compressed Air for the Retractable Fitting Process and Service Positions**

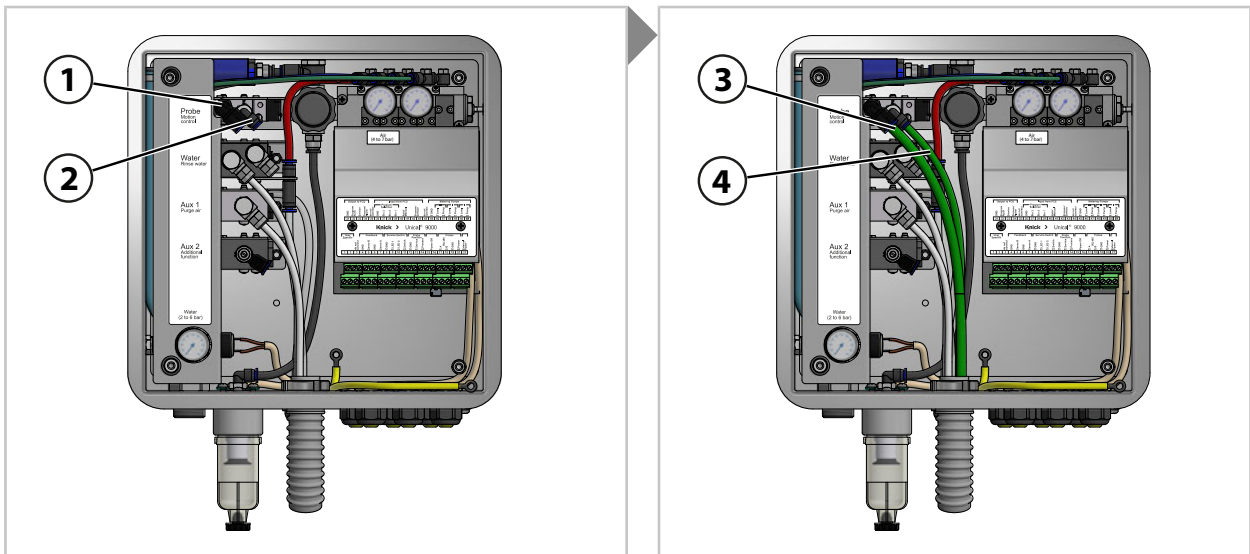

01. Push the green hose DN 8 (3) fully into the control valve (1).
02. Push the green hose DN 6 (4) fully into the control valve (2).

**Aux 2 Compressed Air for Various Applications Option**

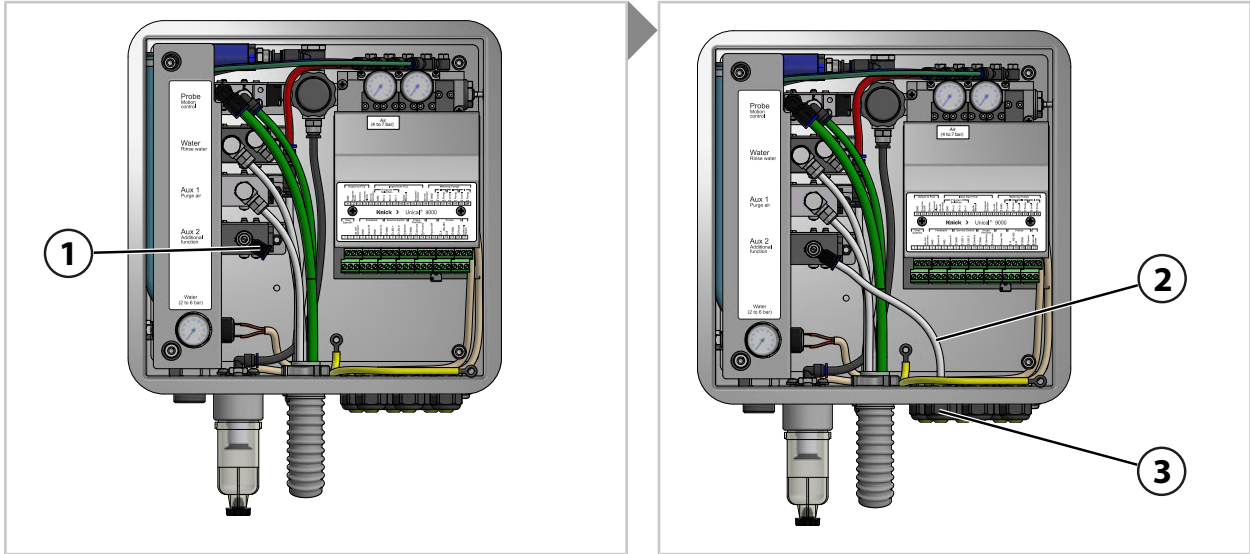

- 01. Guide the hose DN 6 (2) through a cable gland (3).
- 02. Push the hose DN 6 (2) fully in at control valve Aux 2 (1).

**3.2.5 Water Supply Installation**

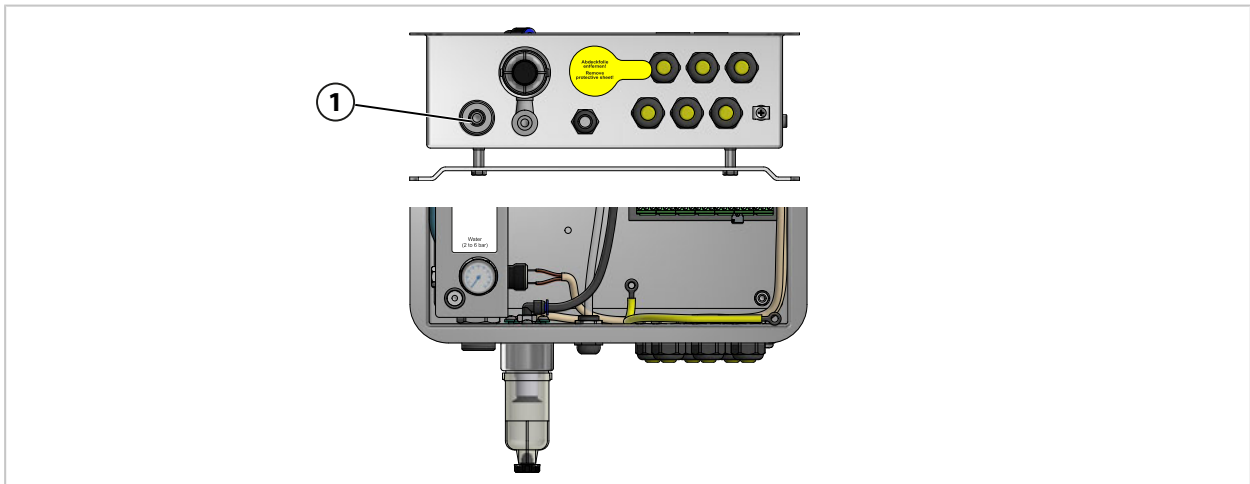

- 01. Attach the connection hose with nipple G $\frac{1}{4}$ " (female thread) or with nipple G $\frac{3}{4}$ " (male thread) to the water supply (1). As applicable, use the ZU0656 water and air connection kit for Unical 9000.  
 → Accessories, p. 93

### 3.2.6 Compressed Air Supply Installation

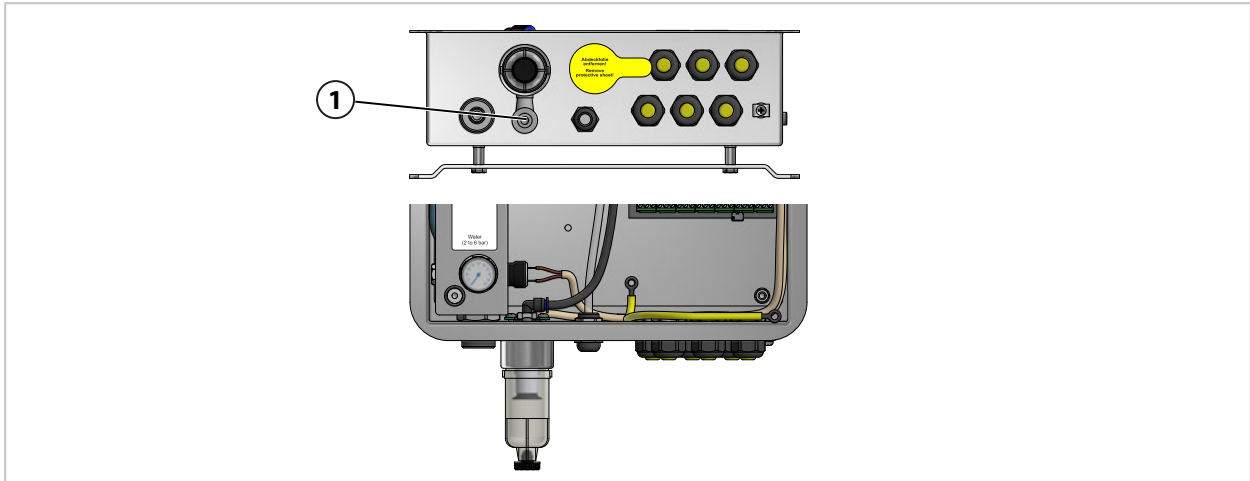

01. Attach the connection hose with nipple G ¼" (female thread) to the compressed air supply **(1)**. As applicable, use the ZU0656 water and air connection kit for Unical 9000. → *Accessories, p. 93*



### 3.2.7 Installing the Media Adapter with Metering Pumps and Containers

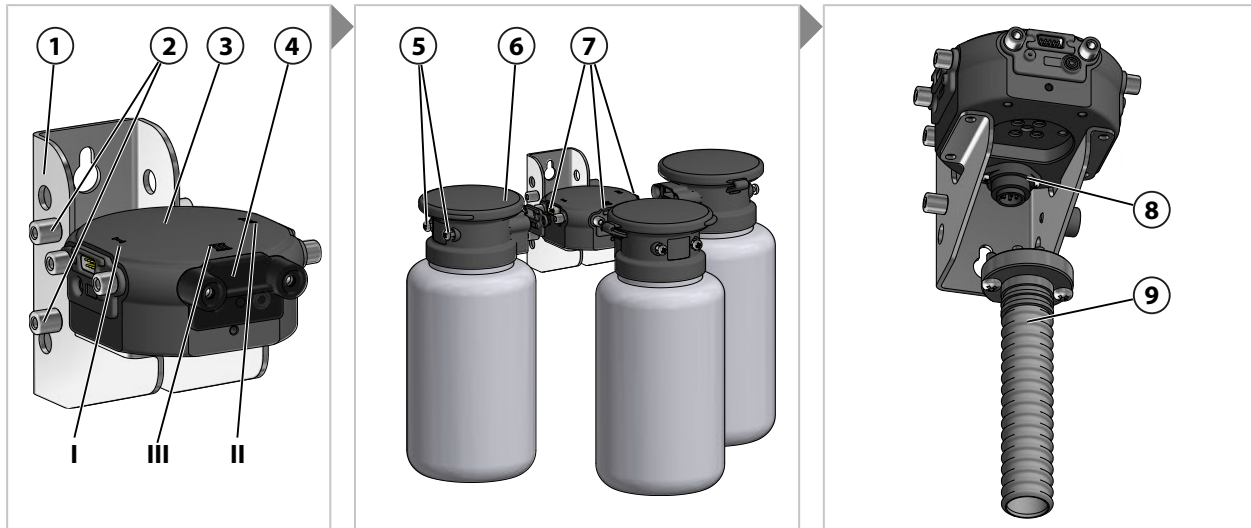

**Note:** Port III is designed for use with aggressive media (e.g., diluted acids, diluted bases, solvents).  
 → *Metering Pump: Filling the Containers, p. 67*

01. Fit the required number of metering pumps (6) to ports I, II, or III (7) on the media adapter (3). As applicable, remove attached blind plates (4) prior to installation.
02. Tighten the fastening screws (5).  
**Note:** Seal off unused ports with a blind plate (4).
03. Fit the media connection (9) to the port (8) of the media adapter (3) and fasten with Phillips screws.

**Note:** The bolts (2) on the wall holder (1) are used to store unused blind plates (4).

### 3.2.8 Industrial Transmitter Installation

For information on installing the industrial transmitter, see the corresponding Installation Instructions or User Manual. → [knick.de](http://knick.de)

### 3.2.9 Retractable Fitting Installation

For information on installing the retractable fitting, see the corresponding User Manual. → [knick.de](http://knick.de)

### 3.3 Electrical Installation

**Note:** Observe installation clearances. The cables are pre-assembled.

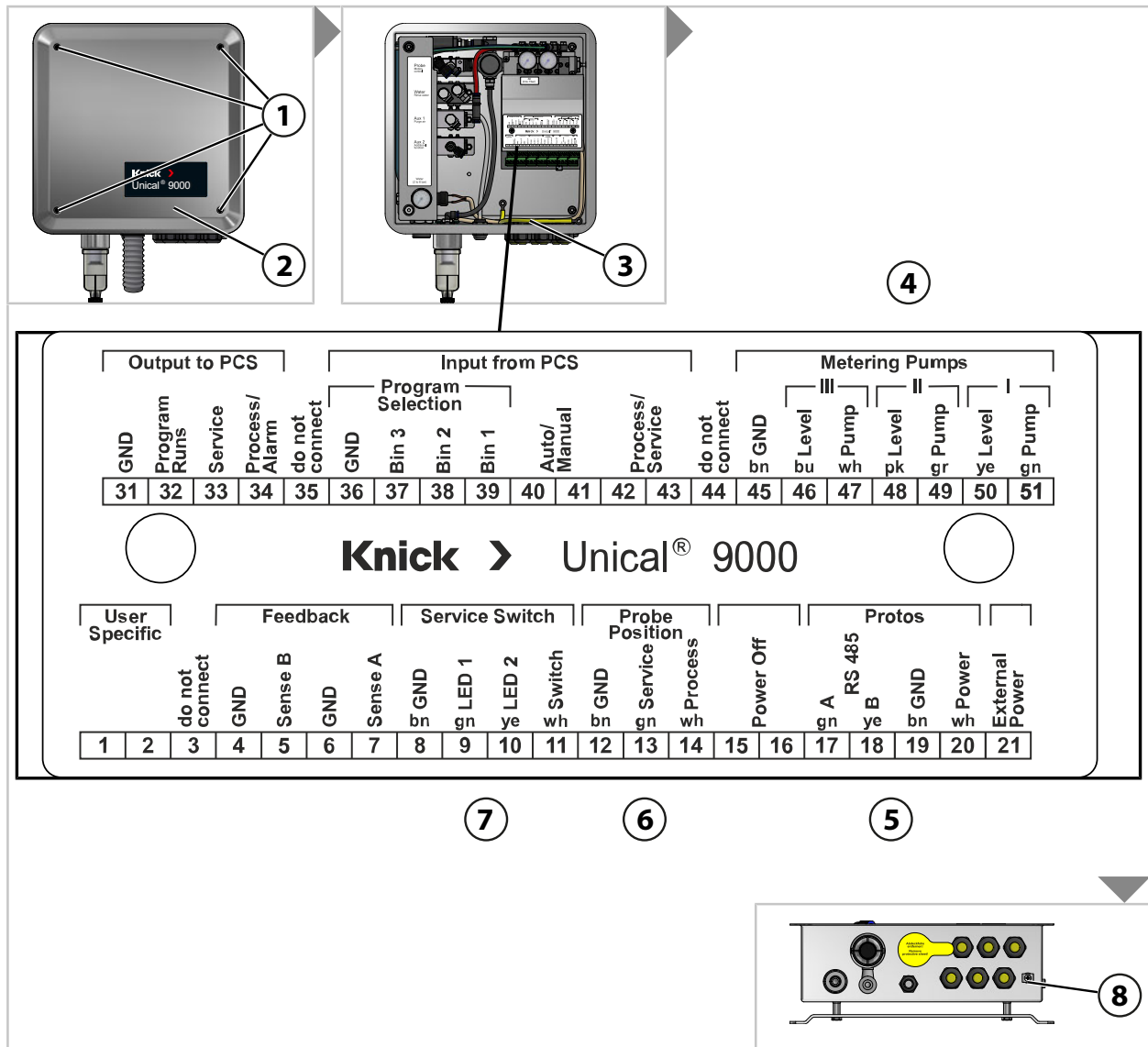

01. Remove four screws **(1)** from the top piece **(2)**.
02. Remove the equipotential bonding cable **(3)** from the top piece **(2)**.
- NOTICE!** Damage to the screw terminals due to excessive tightening torque. Tighten the screw terminals with a max. torque of 0.8 Nm.
03. Connect the cable (to connect Unical 9000 to the media adapter) **(4)** to terminals 45 ... 51.
04. Connect the cable (to connect Unical 9000 to the industrial transmitter) **(5)** to terminals 17 ... 20.
05. Connect the limit position check-back cable **(6)**<sup>1)</sup> to terminals 12 ... 14.
06. Connect the cable (to connect Unical 9000 to the service switch) **(7)** to terminals 8 ... 11.
07. Connect the equipotential bonding **(3)** to the top piece **(2)**.
08. Fasten the top piece **(2)** with screws **(1)**.
09. Connect the grounding connection **(8)** to the system's equipotential bonding.

<sup>1)</sup> In the media connection

**Wiring (Example)**

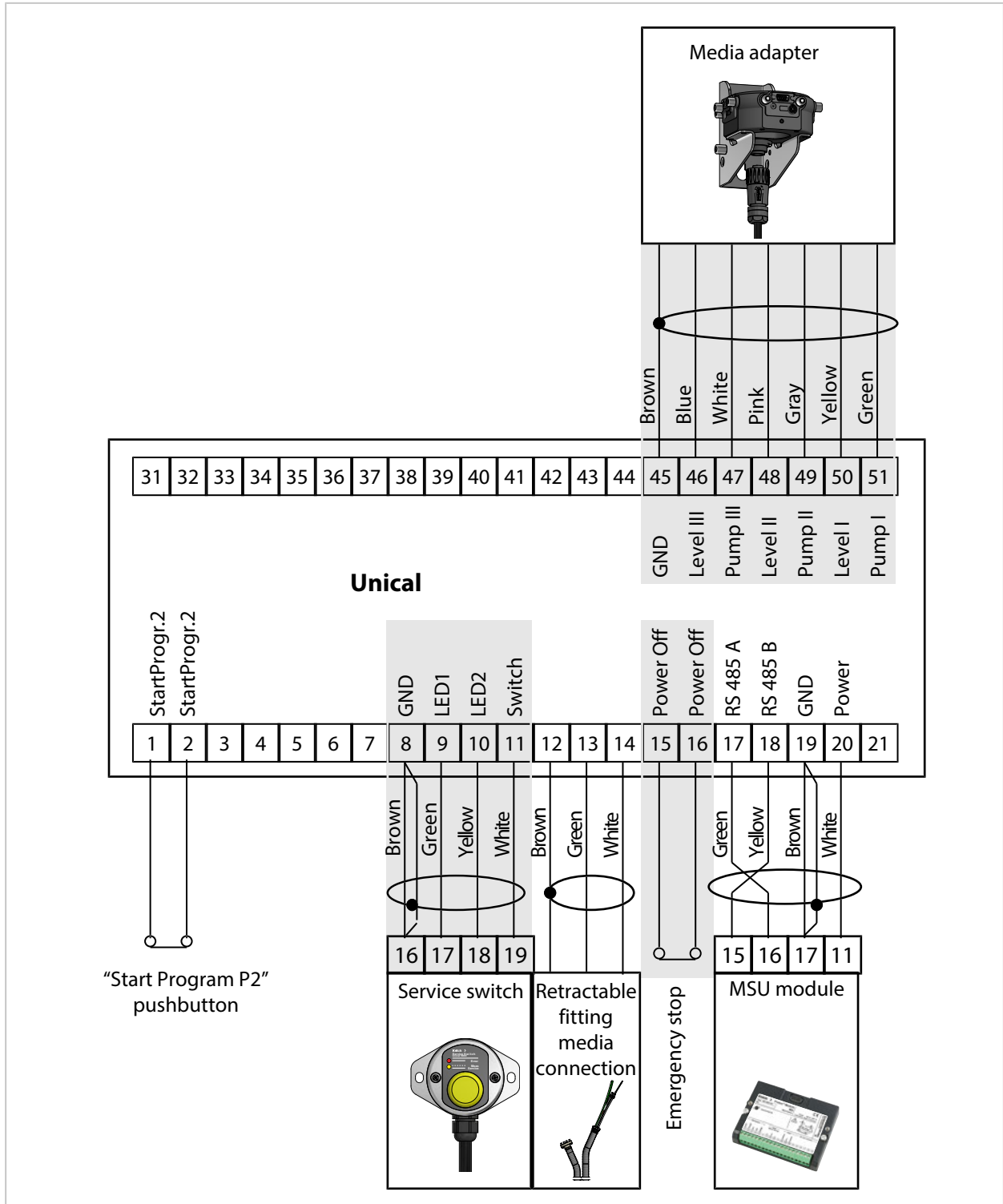

**Note:** Terminals 15-16 are supplied with a jumper. Emergency stop must be connected by a licensed electrician.

**Note:** Terminals 1 and 2 are assigned program P2 "Cal2P" (two-point calibration). An optional Start program P2 pushbutton must be connected by the operating company.

## Terminal Assignments

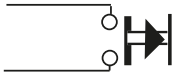
No.	Wire Color	Terminal	Function
1			Manual start of program P2 (factory setting: Cal2P) via external pushbutton
2			
3		Do not connect	Do not connect.
4		GND	Ground
5		Sense B	Do not connect.
6		GND	Ground
7		Sense A	Do not connect.
8	Brown	GND	Service switch ground
9	Green	LED1	Service switch LED 1
10	Yellow	LED2	Service switch LED 2
11	White	Switch	Service switch
12	Brown	GND	Retractable fitting: Check-back signal ground
13	Green	Service	Retractable fitting: SERVICE limit position check-back signal
14	White	Process	Retractable fitting: PROCESS limit position check-back signal
15		Power Off	Emergency stop
16		Power Off	Emergency stop
17	Green	A RS 485	RS-485 interface
18	Yellow	B RS 485	RS-485 interface
19	Brown	GND	Power supply ground
20	White	Power	Power supply Protos
21		Ext. Power	External power supply
31		GND	PCS message ground
32		Program runs (PCS out)	Unical program running.
33		Service (PCS out)	Retractable fitting in SERVICE limit position
34		Process / Alarm	Retractable fitting in PROCESS limit position (or alarm output)
35		Do not connect	Do not connect.
36		GND	PCS program ground
37		Bin 3 (PCS in)	Start programs P1 ... P6.
38		Bin 2 (PCS in)	
39		Bin 1 (PCS in)	
40		Auto/Manual (PCS in)	Lock/unlock automatic program starts.
41		Auto/Manual (PCS in)	
42		Process/Service (PCS in)	Start service mode.
43		Process/Service (PCS in)	
44		Do not connect	Do not connect.
45	Brown	GND	Pump 1 ... 3 ground
46	Blue	Level III	Pump 3 level monitoring
47	White	Pump III	Pump 3 control valve
48	Pink	Level II	Pump 2 level monitoring
49	Gray	Pump II	Pump 2 control valve
50	Yellow	Level I	Pump 1 level monitoring
51	Green	Pump I	Pump 1 control valve

### Terminal Assignments – Under Terminal Cover

These contacts are pre-wired at the factory.

Valves												Monitoring								
GND	Reserve	GND	Auxiliary 2	GND	Auxiliary 1	GND	Water	GND	Probe	GND	Safety	GND	Sense pressure (air)	Sense reserve	GND	Sense water	GND	Sense electrode	GND	Sense water stop
61	62	63	64	65	66	67	68	69	70	71	72	73	74	75	76	77	78	79	80	81
No.	Wire Color	Terminal		Function																
61		GND		Do not connect.																
62		Reserve		Do not connect.																
63		GND		Pilot valve Aux 2 ground																
64		Auxiliary 2		Pilot valve Aux 2																
65		GND		Pilot valve Aux 1 ground																
66		Auxiliary 1		Pilot valve Aux 1																
67		GND		Pilot valve water ground																
68		Water		Pilot valve water																
69		GND		Pilot valve retractable fitting ground																
70		Probe		Pilot valve retractable fitting																
71		GND		Safety valve ground																
72		Safety		Safety valve																
73		GND		Compressed air monitoring ground																
74		Sense pressure (air)		Compressed air monitoring																
75		Sense reserve		Do not connect.																
76		GND		Water monitoring ground																
77		Sense water		Water monitoring																
78		GND		Dismount guard ground																
79		Sense electrode		Dismount guard																
80		GND		Leak monitoring ground																
81		Sense water stop		Leak monitoring																

### 3.3.1 Service Switch Electrical Installation

**Note:** The cable is ready for connection. Do not shorten the cable, but place it rolled up with a cable tie at the installation location.

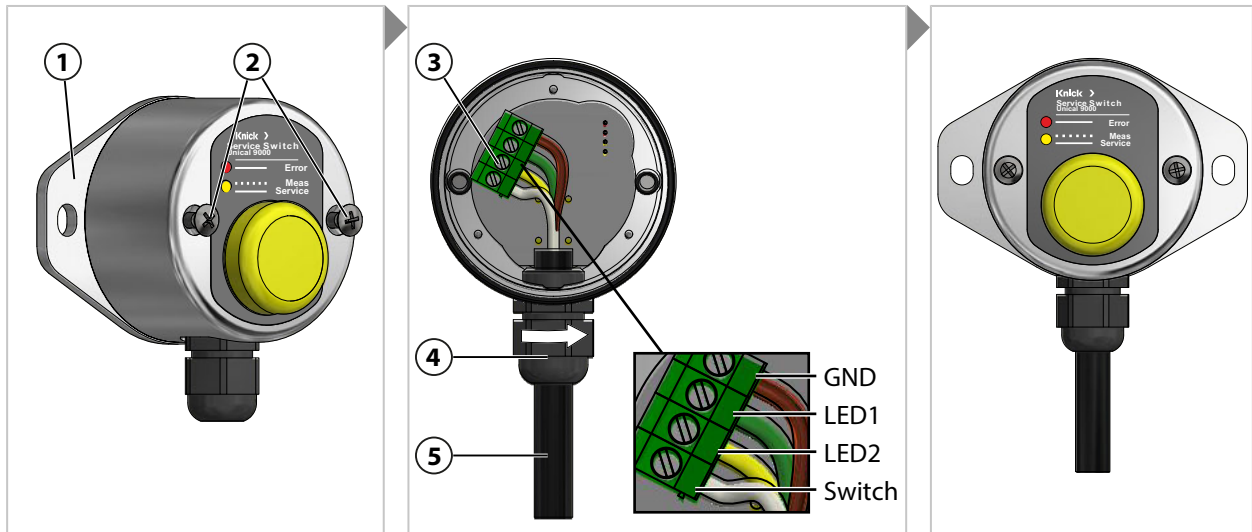

- 01. Remove the screws **(2)** and the wall holder **(1)** with O-ring 55 x 2.5 mm.
- 02. Guide the cable **(5)** through the cable gland **(4)**.

**NOTICE!** Damage to the screw terminals due to excessive tightening torque. Tighten the screw terminals with a max. torque of 0.8 Nm.

- 03. Connect the cable ends to the terminal strip **(3)**.
- 04. Fasten the cable **(5)** by turning the cable gland **(4)**.
- 05. Screw the wall holder **(1)** with O-ring 55 x 2.5 mm to the service switch.
- 06. Tighten the screws **(2)**.

### 3.3.2 Media Adapter Electrical Installation

**Note:** The cable is ready for connection. Do not shorten the cable, but place it rolled up with a cable tie at the installation location.

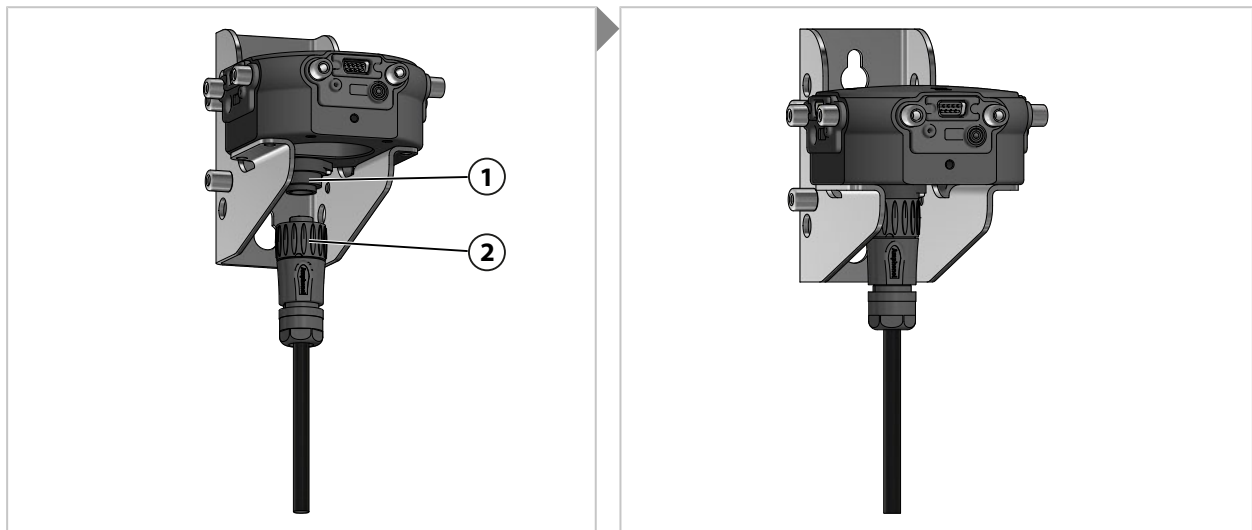

- 01. Screw the plug with coupling nut **(2)** into the media adapter **(1)** and tighten.

### 3.4 Process Control System Installation

#### Unical 9000 Inputs/Outputs

No.	Designation	Input I/ Output O	Level	Function
42	Process / Service	I	0	Normal operation
43			1	Service mode active → <i>Service Mode</i> , p. 74
40	Auto / Manual	I	0	Automatic interval control by industrial transmitter
41			1	Automatic intervals locked
37	Bin 3	I		Program selection and start, manual/PCS <sup>1)</sup> (program P1 ... P6)
38	Bin 2			
39	Bin 1			
34	Process / Alarm	O	0	
			1	Retractable fitting in PROCESS limit position (or alarm)
33	Service	O	0	
			1	Retractable fitting in SERVICE limit position
32	Program runs	O	0	
			1	Program running

**NOTICE!** Risk of product damage caused by excessive load on the PCS outputs. Make sure that the maximum load of  $U_i = 30\text{ V}$ ,  $I_i = 100\text{ mA}$  at terminals 31-34 is not exceeded. This can be achieved by connecting a  $10\text{ k}\Omega$  pull-up resistor upstream of the inputs. Terminal 31 must be connected to signal ground (GND).

For the control inputs (terminals 36 ... 43), the active signal level (< 2 V or 10 ... 30 V) can be defined in the parameter settings:

Parameter Setting ▶ [...C] Unical ▶ Installation ▶ External Control (PCS)

→ *External Control via Process Control System (PCS)*, p. 63

<sup>1)</sup> Signal duration at least 2 s (passing contacts)

**Hazardous Location Connection to a Process Control System (PCS)**

In hazardous locations, connection to a process control system is only possible with valve control modules/switch amplifiers for communication with the Unical 9000-X. The dividing line in the diagram below represents the demarcation of the hazardous location.

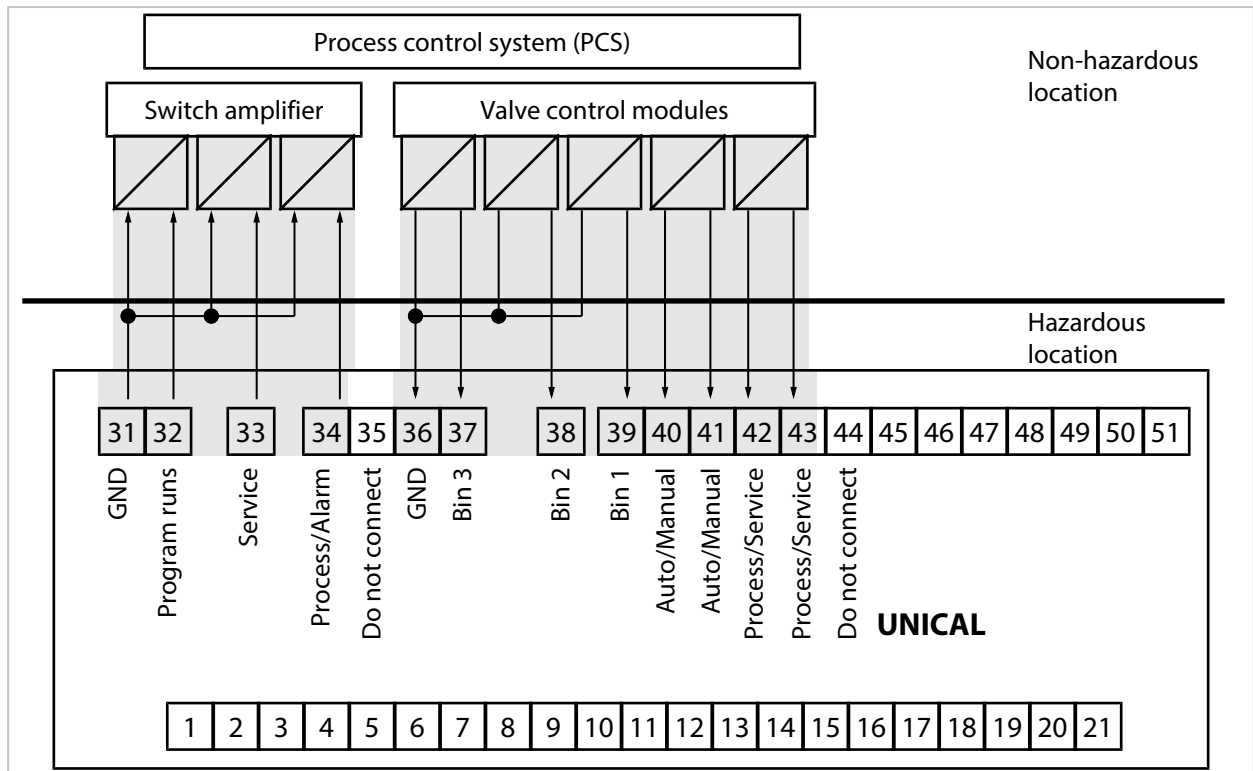

**Note:** The GND lines should be connected as close as possible to the Unical 9000. Do not connect terminal 31 (GND) to terminal 36 (GND).

See also

→ *External Control via Process Control System (PCS), p. 63*



## 4 Commissioning

**⚠ WARNING! Damage or improper installation may cause process medium, potentially containing hazardous substances, to leak out of the media adapter with metering pumps or the retractable fitting.** Adhere to the safety instructions.

**Note:** Commissioning and operating personnel instruction may be carried out by Knick Elektronische Messgeräte GmbH & Co. KG service engineers (ZU0649 → *Accessories, p. 93*).

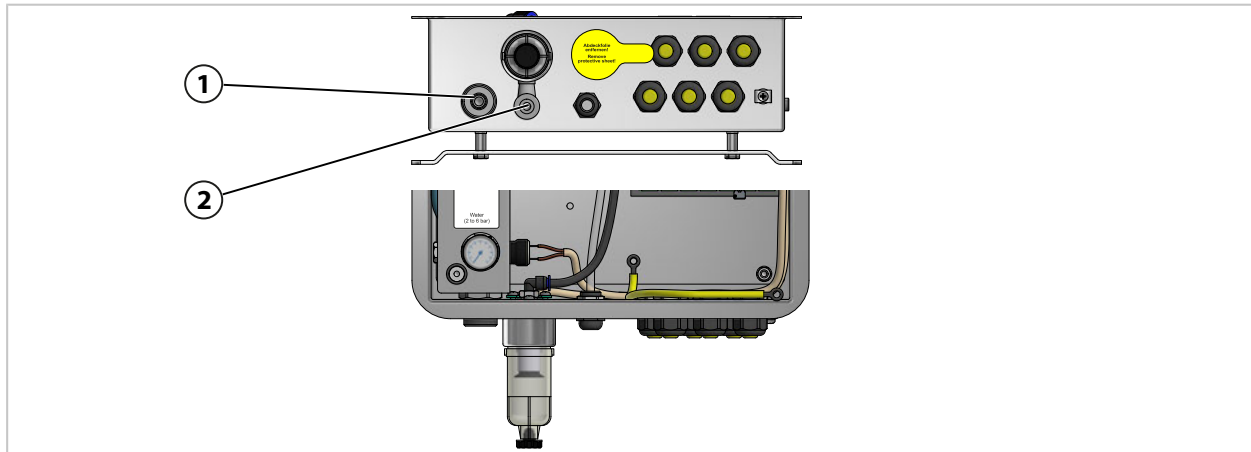

01. Install the Unical 9000 electro-pneumatic controller, the media adapter with metering pumps and containers, and the service switch on a wall or pipe. → *Installation, p. 21* → *Pipe Installation, p. 24*
02. Install the retractable fitting.<sup>1)</sup>
03. Install the Protos industrial transmitter.<sup>2)</sup>
04. Check whether the power supply for the Protos industrial transmitter is available. Connect the power supply as necessary.
05. Install the media connection. → *Media Connection Installation, p. 26*
06. Install the supply connections for the retractable fitting and media adapter.  
→ *Installing the Retractable Fitting and Media Adapter Supply, p. 27*
07. Connect the water supply **(1)**. → *Water Supply Installation, p. 31*
08. Check the pressure on the water manometer. This should be 2 ... 6 bar (29 ... 87 psi).
09. Check the water tightness.
10. Connect the compressed air supply **(2)**. → *Compressed Air Supply Installation, p. 32*  
**Note:** When shutting off the compressed air upstream of the Unical 9000, the pressure may drop by a maximum of 10 % within 30 s.
11. Check the tightness of the compressed air connection.
12. Fill the metering pump container. → *Metering Pump: Filling the Containers, p. 67*
13. Electrically connect the devices. → *Electrical Installation, p. 34*

<sup>1)</sup> Refer to the User Manual for the retractable fitting.

<sup>2)</sup> Refer to the User Manual for the industrial transmitter.

## 5 Parameter Setting

### 5.1 Protos Parameter Setting

See the relevant User Manuals for basic parameter setting of the Protos II 4400 industrial transmitter and the MSU4400-180 module. → [knick.de](http://knick.de)

#### Structure of a Parameter Setting Menu

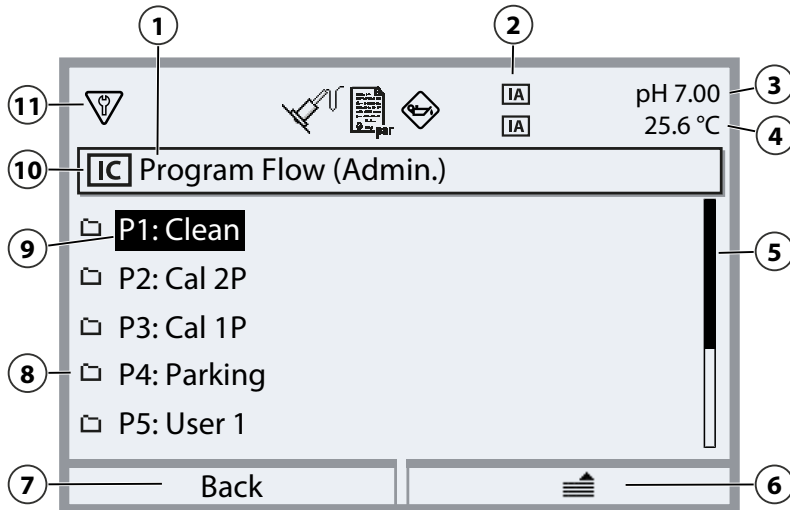

1	Current menu heading	7	Softkey function display
2	Measuring channels of assigned sensor	8	Folder element: Submenu available
3	Primary measured value	9	Selected menu line
4	Measured temperature	10	Current measuring channel
5	Scrollbar	11	Status line with icons
6	Softkey function display (here: context menu)		

Explanation of icons → *Symbols and Markings on the Display, p. 105*

**NOTICE!** Changing the parameter settings may trigger unexpected actions (e.g., probe movements, program starts). Prior to parameter setting, press the service switch to move the retractable fitting to the service position (probe in SERVICE). Parameter setting may only be carried out by trained specialists. If necessary, disconnect the retractable fitting from the process.

**Note:** Before the retractable fitting moves to the service position (probe in SERVICE), the function check (HOLD) for the assigned sensor channel is activated. The current outputs and relay contacts behave in accordance with the parameter settings. Function check (HOLD) is ended when the retractable fitting is again in the process position (probe in PROCESS).

The behavior of the PROFIBUS interface is set out in the User Manual for the COMPA3400-081 Protos module.

To control the electro-pneumatic controller Unical 9000 via Protos II 4400, the function must first be selected on the Protos:

- Menu Selection ▶ Parameter Setting ▶ Administrator Level ▶ MSU4400-180 Module
- ▶ Channel C (Sensor/Control)

01. Function: "Control".

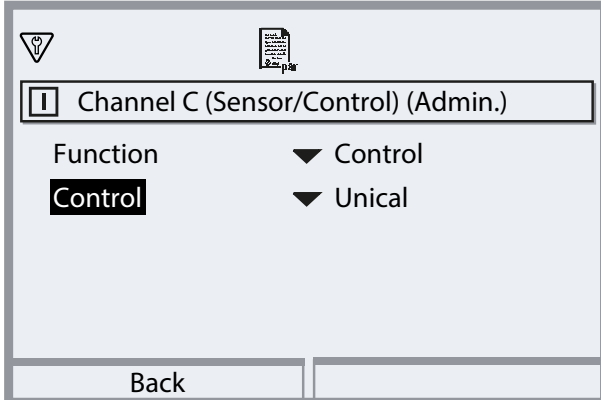

02. 2x **left softkey: Back:** [...C] Unical

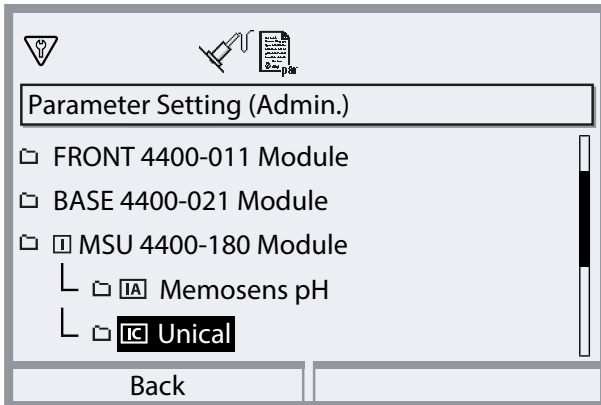

**Unical Menu Parameter Overview**

Submenu	Description
Sensor Channel	Selection of sensor channel used with the retractable fitting. The connected sensor is automatically detected, even after a sensor replacement.
Cal Timer for Prog. → Calibration Timer, p. 44	The selected program is started after the calibration timer has expired.
Time control → Time Control, p. 45	Automatic program starts by Protos (off, fixed interval, weekly program).
Program flow → Control and Service Programs, p. 48	Create and change program flows.
Calibration → Calibration, p. 61	Selection and configuration of Calimatic calibration mode or buffer entry, presetting of procedure (calibration/adjustment).
Installation → Installation, p. 62	Basic settings for measurement procedure, retractable fitting, media adapter.

## Sequence of Parameter Setting for Initial Commissioning

Menu Selection ▶ Parameter Setting ▶ Administrator Level ▶ [...C] Unical

01. Sensor Channel
02. Installation  
(do not execute the last menu item, "Commissioning Program," until parameter setting is complete.) → *Installation, p. 62*
03. Program Flow  
(not required if the preset programs are used without any changes.)  
→ *Control and Service Programs, p. 48*
04. Calibration → *Calibration, p. 61*
05. Other submenus as required.
06. Installation ▶ Commissioning Program → *Commissioning Program, p. 66*

If the configuration has changed, the relevant parameters are transmitted to Unical 9000 when exiting the Unical Parameter Setting menu.

### 5.1.1 Calibration Timer

The calibration timer starts a Unical program to calibrate the sensor after a certain calibration interval has elapsed. Any running programs will be exited first.

Setting of the calibration interval in the Parameter Setting menu of the corresponding sensor channel:

Parameter Setting ▶ ... Module ▶ Cal Presettings ▶ Calibration Timer

Select the Unical program to be started:

Parameter Setting ▶ [...C] Unical ▶ Cal Timer for Prog.

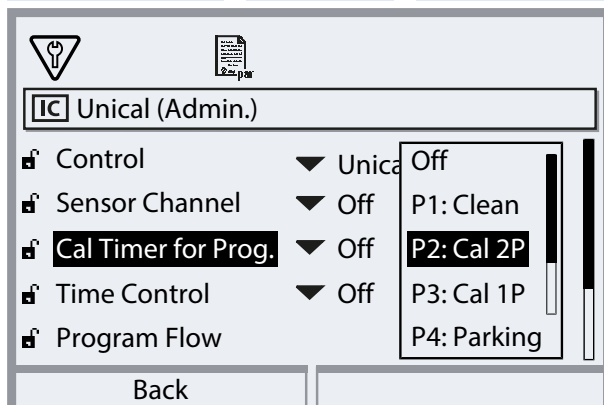

With the exception of the service program, all available programs can be selected. The only prerequisite is that the program contains a calibration. If a program without calibration is selected, it will be constantly repeated by the calibration timer due to the lack of a check-back signal indicating a correctly executed calibration.

If the calibration timer has expired and the sensor has since been replaced, the program already planned for the previous sensor will still run. The calibration interval of the new sensor only takes effect afterwards.

### 5.1.2 Time Control

Parameter Setting > [...C] Unical > Time Control

Time control is used for a time-controlled automatic start of Unical programs.

- Fixed interval
- Weekly program

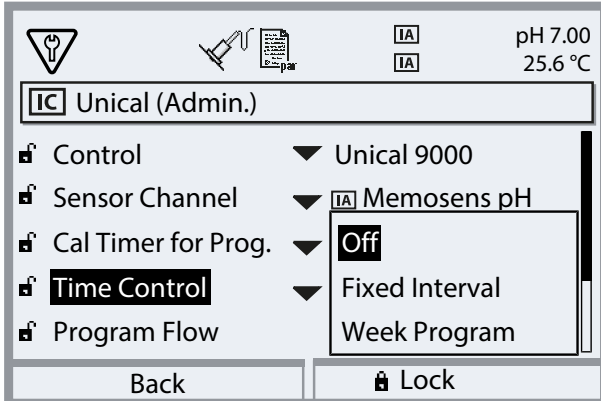

If a program cannot be started immediately at the desired time, e.g., because the system is currently in the service mode, the program start is pushed to the next possible time. If a program could not be started several times, only one start-up will be performed.

Exception: Service mode was triggered by the service switch. In this case, the program start is not made up.

Subsequent program starts are again based on the original interval.

#### Fixed Interval

“Fixed Interval” allows the selection of up to three programs. An interval time can be assigned to each program.

When the system is started, the programs are executed one after the other. The interval time starts for all programs together with the system start-up.

If the configuration for a program is changed (program selection or interval time), the program is executed directly afterwards and the interval time starts with the program start.

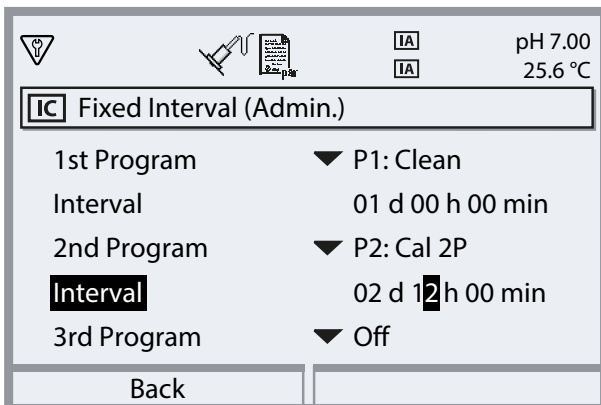

## Weekly Program

“Weekly Program” allows you to compile programs for individual days of the week.

Description of programs → *Control and Service Programs*, p. 48.

Up to 10 program triggers can be defined per day.

01. Select the weekday using the arrow keys.
02. Press **enter** or the **right arrow key** to open the editing menu.
03. Compile the program triggers with the **right softkey**: “Insert Before”, “Insert After”, or “Delete”.  
Select with the **up/down arrow keys** and **enter**.

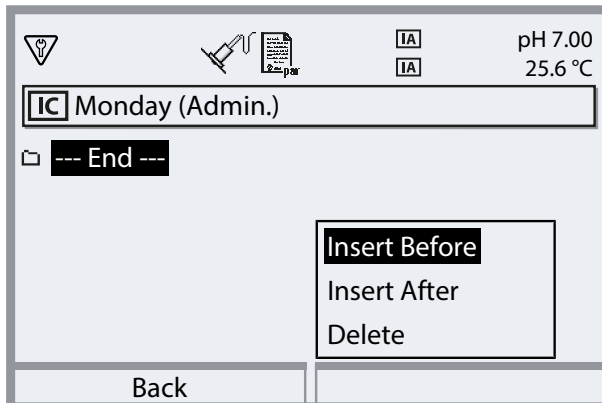

- ✓ When inserting a new program trigger, it is initially preset with program “P4: Parking”, single start at 08:00.

04. Press **enter** or the **right arrow key** to open the editing menu “P4: Parking”.

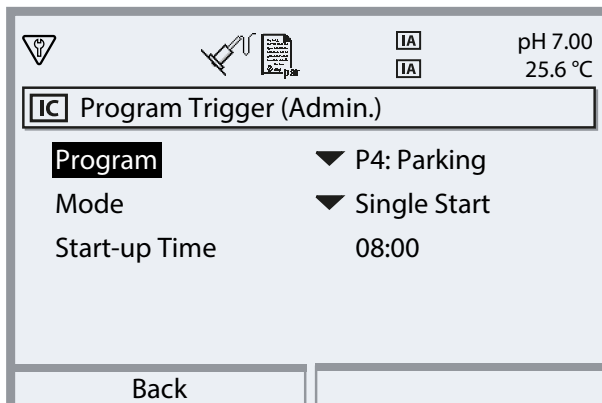

05. Use the **right arrow key** and **up/down arrow keys** to select the desired program and confirm by pressing **enter**.

06. Select “Mode” using the **arrow keys**: single start or interval.

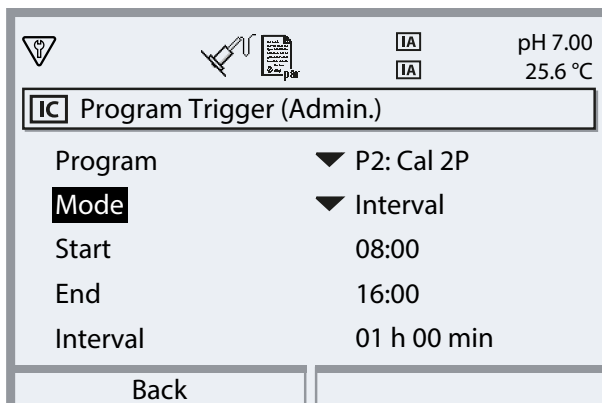

07. Use the **arrow keys** to enter the relevant times.

- 08. **Left softkey: Back:** Select further program triggers accordingly.
- 09. When finished, open the weekly program by pressing the **left softkey: Back** and configure further weekdays.
- 10. When configuration is complete, press the **left softkey: Back** to exit the weekly program.

**Note:** After selecting a weekday, you can copy the configured daily program and apply it to another weekday by pressing the **right softkey**. The copied daily program can then be subsequently modified.

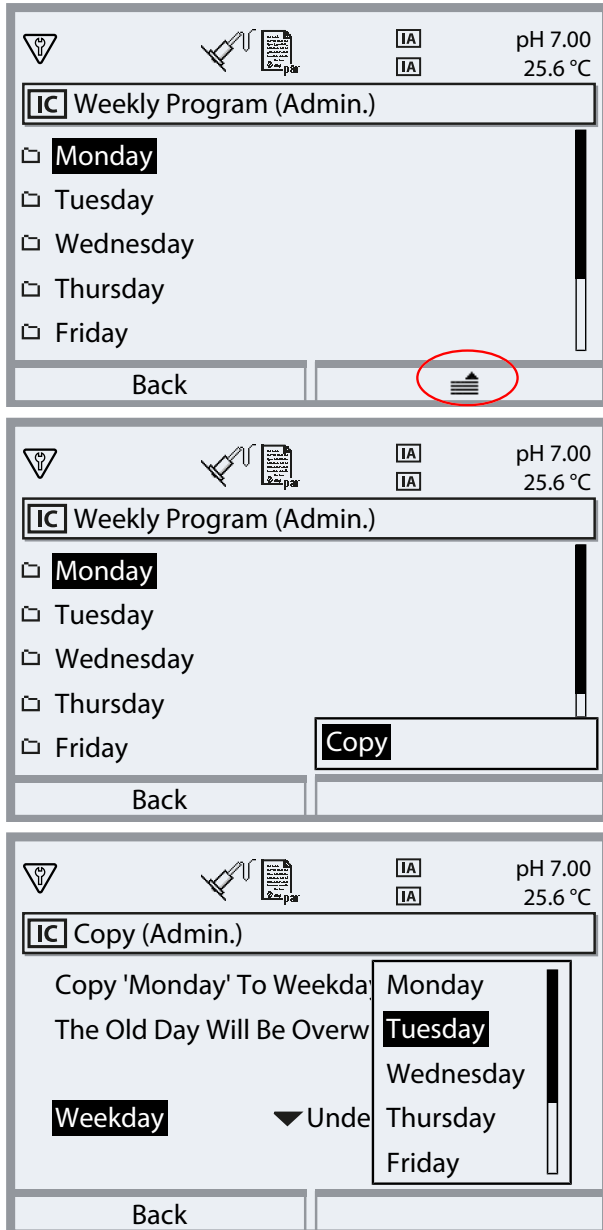

### 5.1.3 Control and Service Programs

Six control programs P1 ... P6 and one service program P7 are available. Five program flows (P1 ... P4, P7) are preset on delivery (factory setting). Two additional programs can be entered by the user (User 1, User 2). The preset programs can also be renamed or modified.

Configuration of program flows → *Configuring the Program Flow, p. 60*

Program starts

- Via passive inputs Bin 1 ... 3 (terminals 37 ... 39) or "Process/Service" (terminals 42, 43) on Unical (see table).
- Via PROFIBUS using the COMPA module (for a description, see the COMPA3400-081 User Manual)
- Manually on Protos: [Menu Selection](#) ▶ [Maintenance](#) ▶ [\[...\] Unical](#) ▶ [Start Program](#)
- By the Protos calibration timer → *Calibration Timer, p. 44*
- Via time control (fixed interval or weekly program) → *Time Control, p. 45*
- Program P2 also via pushbutton on Unical (terminals 1 ... 2)

#### Program Start Via Process Control System (PCS)

**Note:** The 24 V power supply must be provided externally or by the PCS.

Program	Description	Bin 3	Bin 2	Bin 1
P1	Clean/Measure <sup>1)</sup>	0	0	1
P2	Cal 2P (two-point calibration)	0	1	0
P3	Cal 1P (one-point calibration)	0	1	1
P4	Parking	1	0	0
P5	User 1 (user-programmable)	1	0	1
P6	User 2 (user-programmable)	1	1	0

Program P7 "Service" is started via terminals 42, 43 "Process/Service". It is used to move the retractable fitting to the service position and to activate service mode. → *Service Mode, p. 74*

If the retractable fitting is already in the service position (probe in SERVICE), the probe is moved to the process position by the start of program P7 "Service," if necessary after cleaning.

**Note:** The signal must be present for a minimum time (approx. 2 seconds) for the control inputs to detect a stable state.

The following applies to program P7 "Service": It immediately ends all running programs (P1 ... P6) and deletes all program tasks issued via the control inputs.

The following applies to programs P1 ... P6: If a program is started, any program currently running is first brought to an end. Further requests are stored and executed afterwards. Each program, however, is only stored once.

Control via inputs Bin 1 ... 3 (terminals 37 ... 39) or "Process/Service" (terminals 42, 43) must be enabled in Protos II 4400:

[Parameter Setting](#) ▶ [\[...\] Unical](#) ▶ [Installation](#) ▶ [Ext. Control \(PCS\) : On](#)

<sup>1)</sup> Dependent on selected measurement procedure (continuous/short-time)



## Program Steps

Program Step	Parameter Setting	Description
Program End		Marks the end of the program.
Probe in SERVICE		Retractable fitting moves to service position (SERVICE limit position).
Probe in PROCESS	Shut-off delay <sup>1)</sup> 0 ... 08:00:00 [hh:mm:ss]	Retractable fitting moves to process position (PROCESS limit position).
Water On <sup>2)</sup>	Shut-off delay <sup>1)</sup> 0 ... 08:00:00 [hh:mm:ss] Monitoring on/off	Rinse medium is switched on. Monitoring can only be activated if it has already been switched on in the Parameter Setting menu: <a href="#">Parameter Setting</a> ▶ <a href="#">[...] Unical</a> ▶ <a href="#">Installation</a> ▶ <a href="#">Rinse Medium</a> ▶ <a href="#">Monitoring</a> : process value/temperature
Water Off <sup>2)</sup>	Shut-off delay <sup>1)</sup> 0 ... 08:00:00 [hh:mm:ss] Monitoring on/off	Rinse medium is switched off.
Measuring Time	Shut-off delay 0 ... 08:00:00 [hh:mm:ss]	The probe remains in the current position for the duration of the entered shut-off delay. Function check (HOLD) is switched off. When entering the time, take into account the required settling time for the sensor measured value. During this program step, function check (HOLD) is disabled.
Waiting Time	0 ... 08:00:00 [hh:mm:ss]	All states remain unchanged for the entered time.
Goto Row	n = row number Repeat cycle 0 ... 254	Jumps to the specified row number.
Wait Position		Only for control via control inputs Bin 1 ... 3. Program P1 ... P6: Position is held until another bit combination is present for approx. 2 s. Recommendation, so that another program is not started inadvertently afterwards: Set Bin 1 ... 3 to 0. Program P7 Service: Position is held until the service program is again activated.
Space		Can be used as a placeholder.
Medium I <sup>2)</sup>	Shut-off delay <sup>1)</sup> 0 ... 08:00:00 [hh:mm:ss] Monitoring on/off	Medium in container 1 is pumped. Monitoring can only be activated if it has already been switched on in the Parameter Setting menu: <a href="#">Parameter Setting</a> ▶ <a href="#">[...] Unical</a> ▶ <a href="#">Installation</a> ▶ <a href="#">Media Adapter</a> ▶ <a href="#">Port I</a> ▶ <a href="#">Monitoring</a> : process value/temperature
Medium II <sup>2)</sup>	Shut-off delay <sup>1)</sup> 0 ... 08:00:00 [hh:mm:ss] Monitoring on/off	Medium in container 2 is pumped. Monitoring can only be activated if it has already been switched on in the Parameter Setting menu: <a href="#">Parameter Setting</a> ▶ <a href="#">[...] Unical</a> ▶ <a href="#">Installation</a> ▶ <a href="#">Media Adapter</a> ▶ <a href="#">Port II</a> ▶ <a href="#">Monitoring</a> : process value/temperature

<sup>1)</sup> Wait time after execution of the actual program step

<sup>2)</sup> Media designation as configured → *Installation*, p. 62.

Program Step	Parameter Setting	Description
Medium III <sup>1)</sup>	Shut-off delay <sup>2)</sup> 0 ... 08:00:00 [hh:mm:ss] Monitoring on/off	Medium in container 3 is pumped.  Monitoring can only be activated if it has already been switched on in the Parameter Setting menu: <a href="#">Parameter Setting</a> ▶ <a href="#">[...] Unical</a> ▶ <a href="#">Installation</a> ▶ <a href="#">Media Adapter</a> ▶ <a href="#">Port III</a> ▶ <a href="#">Monitoring</a> : process value/temperature
Cal Point 1		Protos performs the first calibration step.
Cal Point 2		Protos performs the second calibration step.
ORP Check		Protos performs the ORP check (when using ORP or pH/ORP sensors).
Aux 1 On <sup>1)</sup>	Shut-off delay <sup>2)</sup> 0 ... 08:00:00 [hh:mm:ss] Monitoring on/off	Additional medium 1 (e.g., purge air) is switched on.
Aux 1 Off <sup>1)</sup>	Shut-off delay <sup>2)</sup> 0 ... 08:00:00 [hh:mm:ss] Monitoring on/off	Additional medium 1 (e.g., purge air) is switched off.
Aux 2 On <sup>1)</sup>	Shut-off delay <sup>2)</sup> 0 ... 08:00:00 [hh:mm:ss] Monitoring on/off	Additional medium 2 is switched on.
Aux 2 Off <sup>1)</sup>	Shut-off delay <sup>2)</sup> 0 ... 08:00:00 [hh:mm:ss] Monitoring on/off	Additional medium 2 is switched off.

Selection of the measurement procedure (continuous/short-time):

[Parameter Setting](#) ▶ [\[...\] Unical](#) ▶ [Installation](#) → *Installation, p. 62*

**Note:** Programs P1, P2, P3 depend on the configured measurement procedure (continuous/short-time). If the measurement procedure is changed, programs P1, P2, P3 must be checked and adjusted if necessary.

<sup>1)</sup> Media designation as configured → *Installation, p. 62.*

<sup>2)</sup> Wait time after execution of the actual program step

**Program Flow P1 “Clean” with “Continuous” Measurement Procedure**

Display Text	Follow-up Delay <sup>1)</sup>
01: Probe in SERVICE	
02: Medium III <sup>2)</sup>	00 h 00 min 20 s
03: Water On <sup>2)</sup>	00 h 01 min 00 s
04: Water Off <sup>2)</sup>	00 h 00 min 02 s
05: Probe in PROCESS	00 h 00 min 05 s
06: Program End	

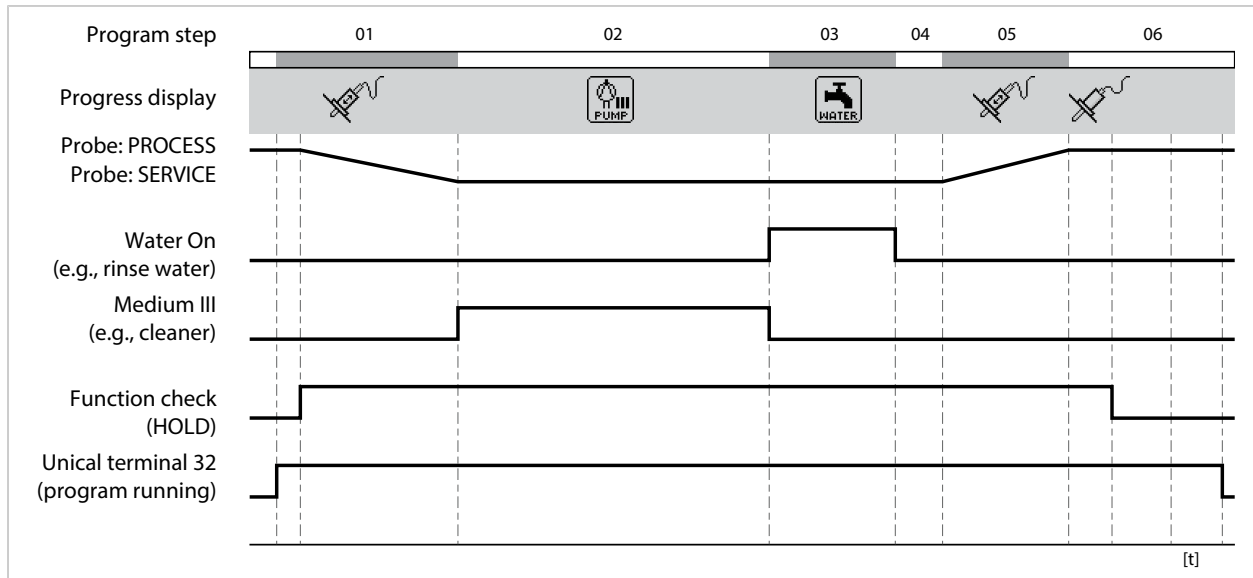

<sup>1)</sup> Wait time after execution of the actual program step

<sup>2)</sup> Media designation as configured → *Installation*, p. 62.

**Program Flow P2 “Cal 2P” (Two-point Calibration) with “Continuous” Measurement Procedure**

Display Text	Follow-up Delay <sup>1)</sup>
01: Probe in SERVICE	
02: Medium III <sup>2)</sup>	00 h 00 min 20 s
03: Water On <sup>2)</sup>	00 h 01 min 00 s
04: Water Off <sup>2)</sup>	00 h 00 min 02 s
05: Medium I <sup>2)</sup>	00 h 00 min 00 s
06: Cal Point 1	
07: Water On <sup>2)</sup>	00 h 00 min 10 s
08: Water Off <sup>2)</sup>	00 h 00 min 02 s
09: Medium II <sup>2)</sup>	00 h 00 min 00 s
10: Cal Point 2	
11: Water On <sup>2)</sup>	00 h 00 min 10 s
12: Water Off <sup>2)</sup>	00 h 00 min 02 s
13: Probe in PROCESS	00 h 00 min 05 s
14: Program End	

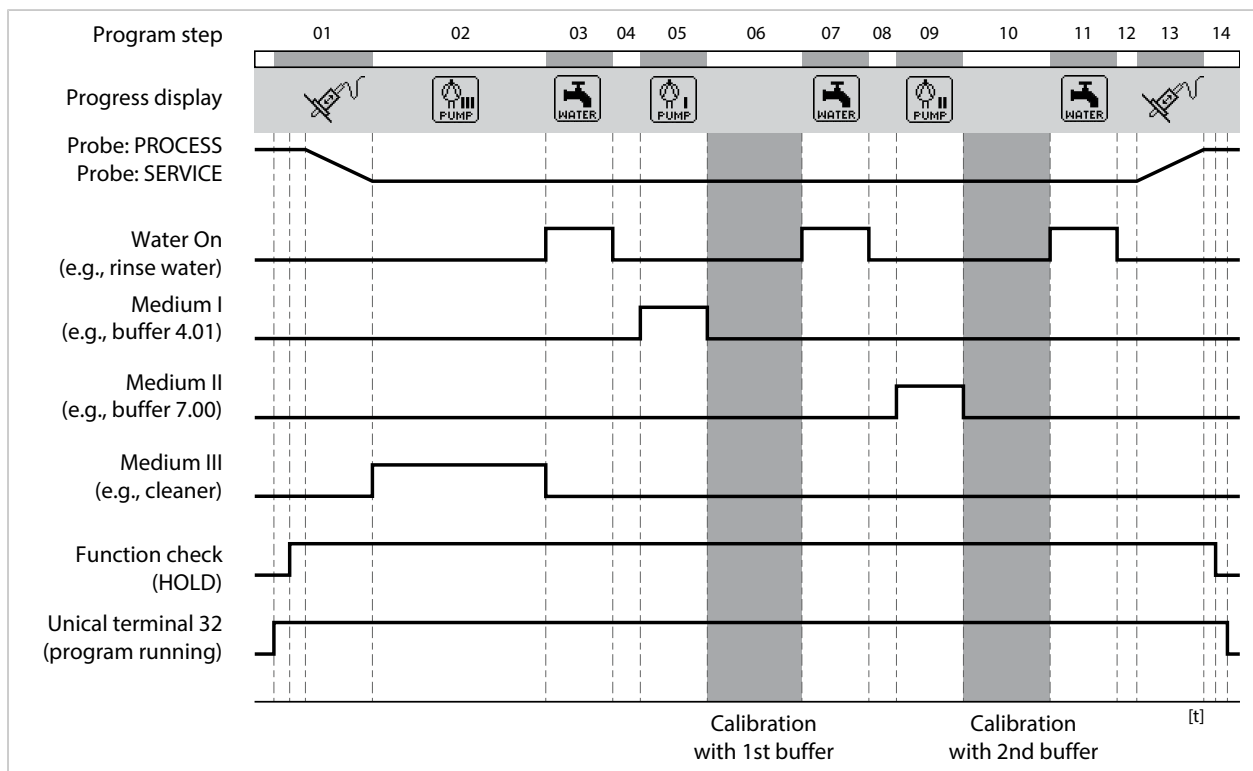

<sup>1)</sup> Wait time after execution of the actual program step

<sup>2)</sup> Media designation as configured → *Installation*, p. 62.

**Program Flow P3 “Cal 1P” (One-point Calibration) with “Continuous” Measurement Procedure**

Display Text	Follow-up Delay <sup>1)</sup>
01: Probe in SERVICE	
02: Medium III <sup>2)</sup>	00 h 00 min 20 s
03: Water On <sup>2)</sup>	00 h 01 min 00 s
04: Water Off <sup>2)</sup>	00 h 00 min 02 s
05: Medium I <sup>2)</sup>	00 h 00 min 00 s
06: Cal Point 1	
07: Water On <sup>2)</sup>	00 h 00 min 10 s
08: Water Off <sup>2)</sup>	00 h 00 min 02 s
09: Probe in PROCESS	00 h 00 min 05 s
10: Program End	

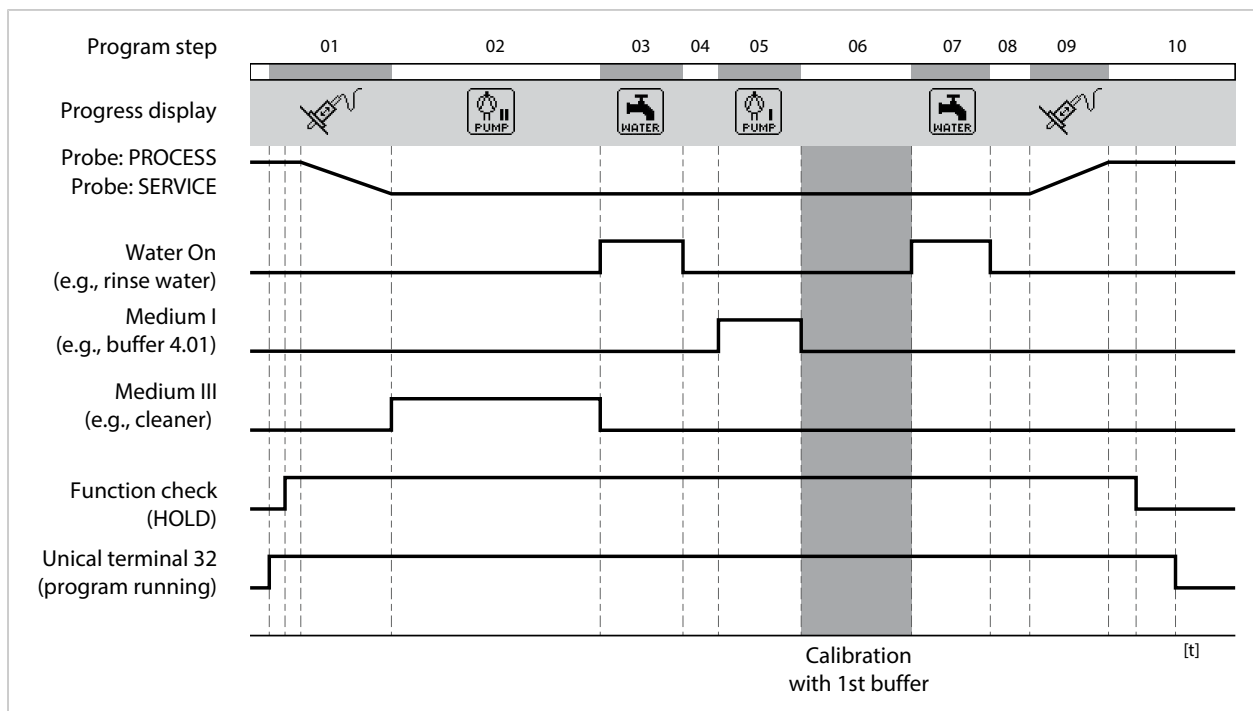

<sup>1)</sup> Wait time after execution of the actual program step

<sup>2)</sup> Media designation as configured → *Installation*, p. 62.

**Program Flow P1 “Measure” with “Short-time” Measurement Procedure**

Display Text	Follow-up Delay <sup>1)</sup>
01: Water On <sup>2)</sup>	00 h 00 min 10 s
02: Water Off <sup>2)</sup>	00 h 00 min 02 s
03: Probe in PROCESS	00 h 00 min 05 s
04: Measuring Time	00 h 00 min 30 s
05: Probe in SERVICE	
06: Medium III <sup>2)</sup>	00 h 00 min 20 s
07: Water On <sup>2)</sup>	00 h 01 min 00 s
08: Water Off <sup>2)</sup>	00 h 00 min 02 s
09: Program End	

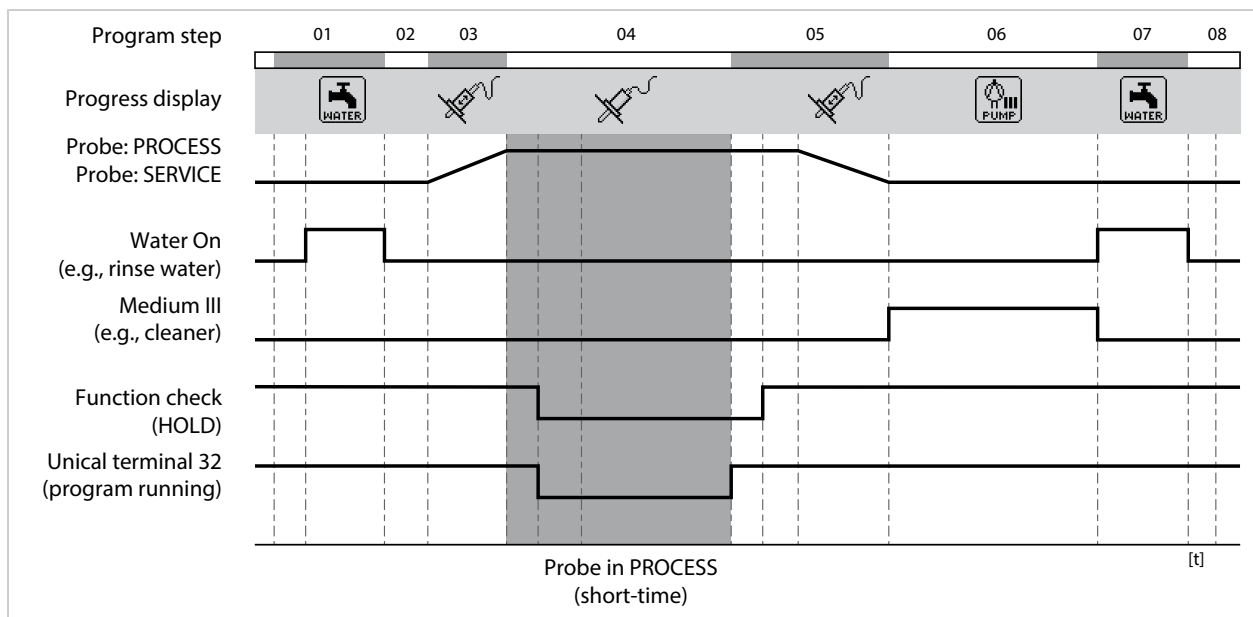

<sup>1)</sup> Wait time after execution of the actual program step

<sup>2)</sup> Media designation as configured → *Installation*, p. 62.

**Program Flow P2 “Cal 2P” (Two-point Calibration) with “Short-time” Measurement Procedure**

Display Text	Follow-up Delay <sup>1)</sup>
01: Water On <sup>2)</sup>	00 h 00 min 10 s
02: Water Off <sup>2)</sup>	00 h 00 min 02 s
03: Medium I <sup>2)</sup>	00 h 00 min 00 s
04: Cal Point 1	
05: Water On <sup>2)</sup>	00 h 00 min 10 s
06: Water Off <sup>2)</sup>	00 h 00 min 02 s
07: Medium II <sup>2)</sup>	00 h 00 min 00 s
08: Cal Point 2	
09: Water On <sup>2)</sup>	00 h 00 min 10 s
10: Water Off <sup>2)</sup>	00 h 00 min 02 s
11: Program End	

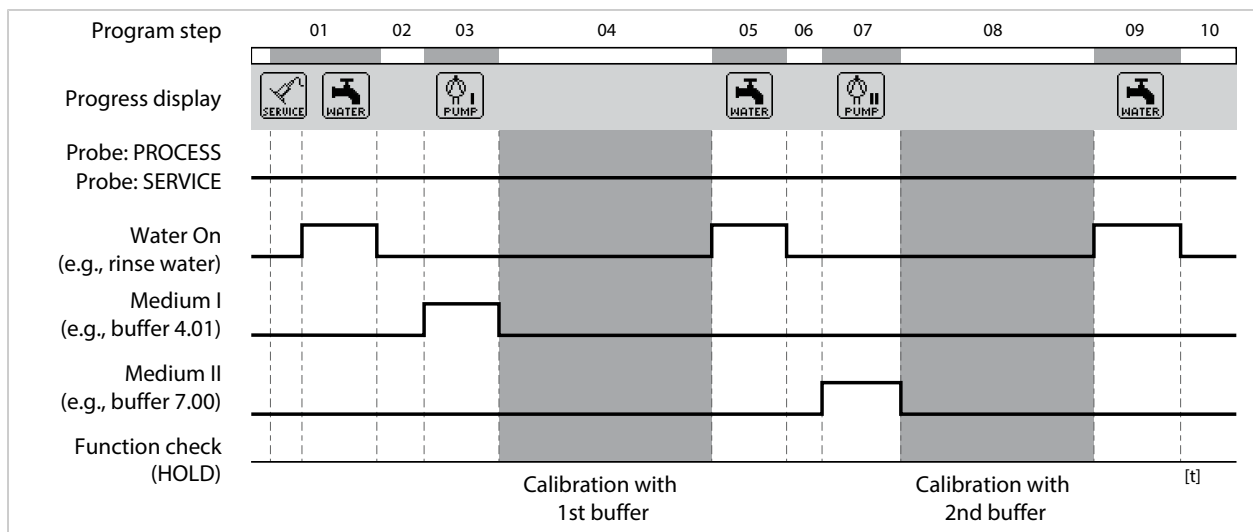

<sup>1)</sup> Wait time after execution of the actual program step

<sup>2)</sup> Media designation as configured → *Installation*, p. 62.

**Program Flow P3 “Cal 1P” (One-point Calibration) with “Short-time” Measurement Procedure**

Display Text	Follow-up Delay <sup>1)</sup>
01: Water On <sup>2)</sup>	00 h 00 min 10 s
02: Water Off <sup>2)</sup>	00 h 00 min 02 s
03: Medium I <sup>2)</sup>	00 h 00 min 00 s
04: Cal Point 1	
05: Water On <sup>2)</sup>	00 h 00 min 10 s
06: Water Off <sup>2)</sup>	00 h 00 min 02 s
07: Program End	

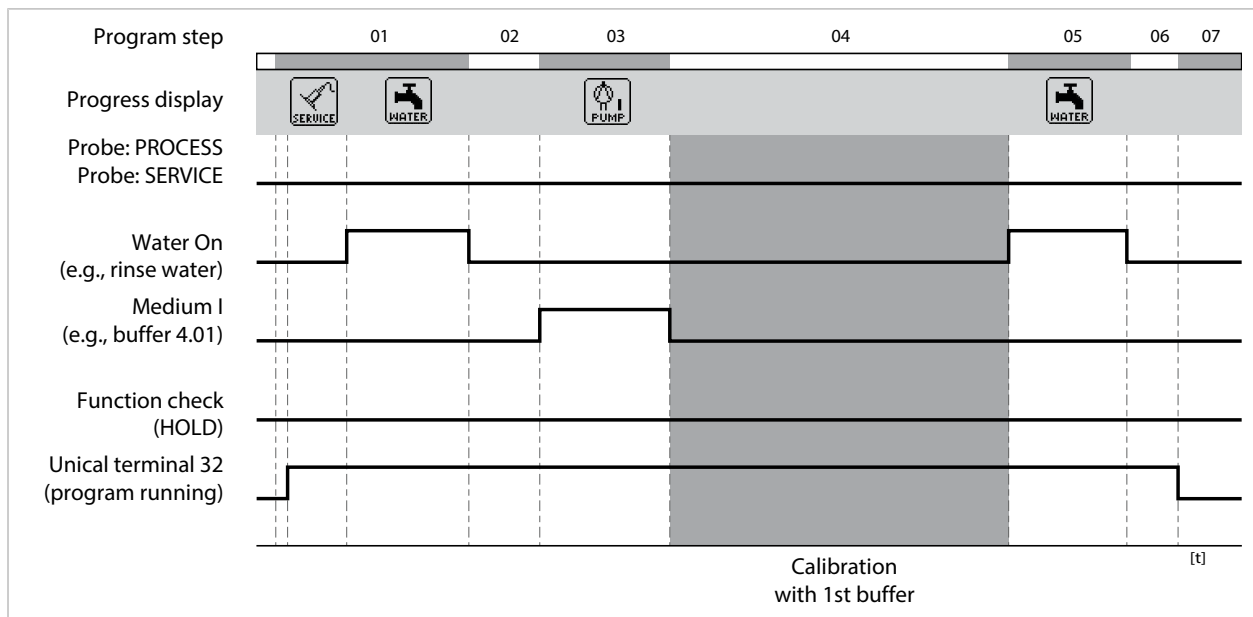

<sup>1)</sup> Wait time after execution of the actual program step

<sup>2)</sup> Media designation as configured → *Installation*, p. 62.



**Program P4 “Parking”**

Program P4 “Parking” features the program step “Wait Position”.

If the program is started via the PCS inputs Bin 1 ... Bin 3 (terminals 37 ... 39) on the Unical 9000, it runs until the “Wait Position” is reached and remains at this point until the signal state at the PCS inputs changes:

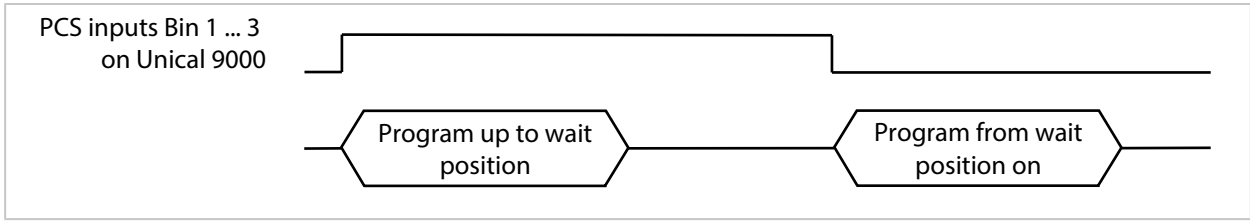

If the program is started by a brief signal at the PCS inputs, the wait position is skipped:

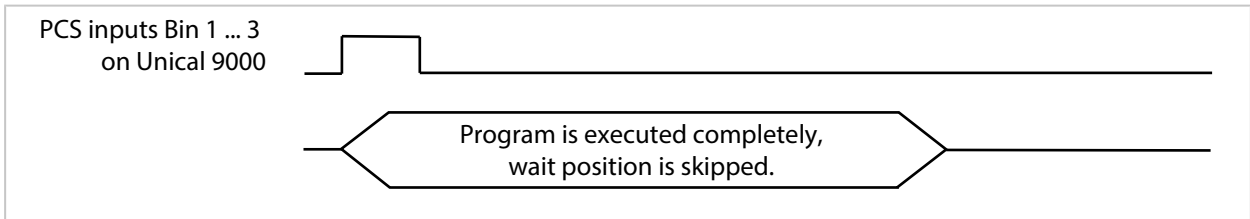

**Note:** The program step is only effective for program starts via the PCS inputs Bin 1 ... Bin 3 on the Unical 9000. For program starts via Protos or PROFIBUS, the wait position is skipped.

Program flow:

Display Text	Follow-up Delay <sup>1)</sup>
01: Probe in SERVICE	
02: Medium III <sup>2)</sup>	00 h 00 min 20 s
03: Water On <sup>2)</sup>	00 h 01 min 00 s
04: Water Off <sup>2)</sup>	00 h 00 min 02 s
05: Aux 1 On <sup>2)</sup>	00 h 00 min 10 s
06: Aux 1 Off <sup>2)</sup>	00 h 00 min 02 s
07: Medium I <sup>2)</sup>	00 h 00 min 02 s
08: Wait Position	Position is held until next command (e.g., PCS).
09: Water On <sup>2)</sup>	00 h 00 min 10 s
10: Water Off <sup>2)</sup>	00 h 00 min 02 s
11: Probe in PROCESS	00 h 00 min 05 s
12: Program End	

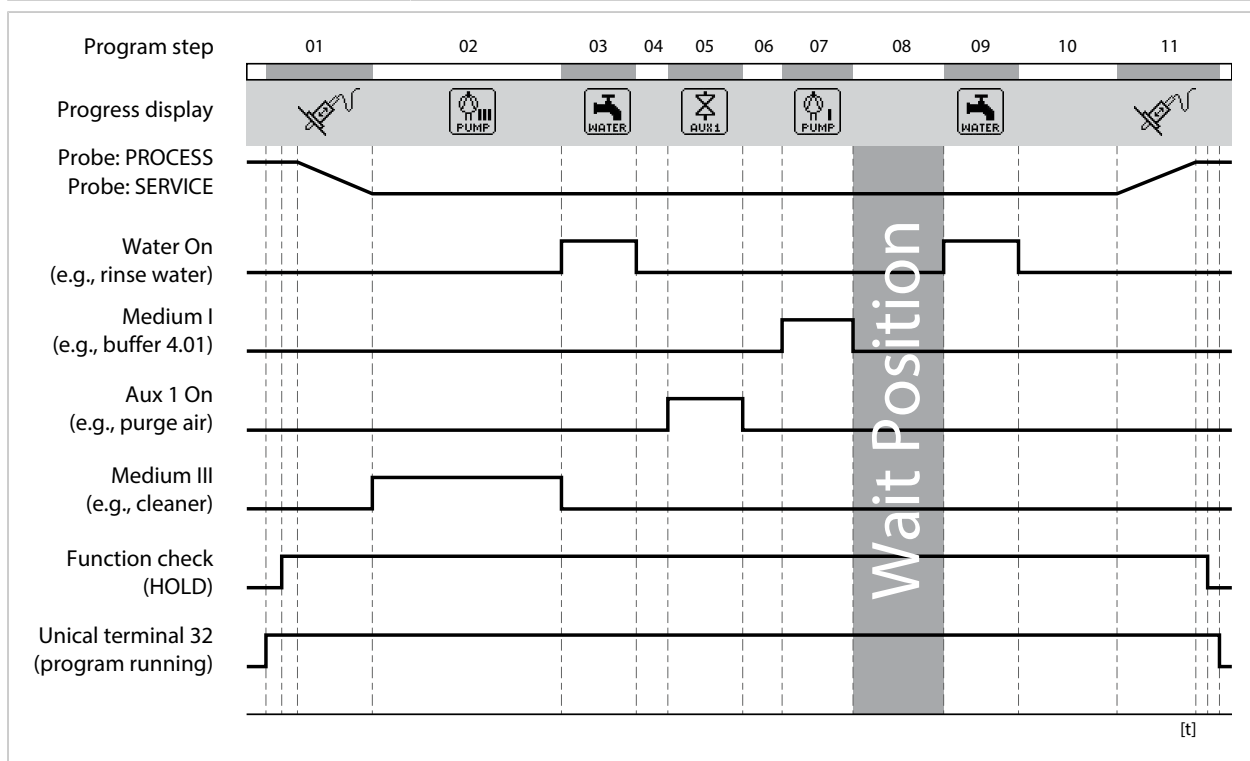

<sup>1)</sup> Wait time after execution of the actual program step

<sup>2)</sup> Media designation as configured → *Installation*, p. 62.

**Program P7 Service**

Program flow:

Display Text	Follow-up Delay <sup>1)</sup>
01: Probe in SERVICE	
02: Medium III <sup>2)</sup>	00 h 00 min 20 s
03: Water On <sup>2)</sup>	00 h 01 min 00 s
04: Water Off <sup>2)</sup>	00 h 00 min 02 s
05: Aux 1 On <sup>2)</sup>	00 h 00 min 05 s
06: Aux 1 Off <sup>2)</sup>	00 h 00 min 02 s
07: Wait Position	
08: Water On <sup>2)</sup>	00 h 00 min 10 s
09: Water Off <sup>2)</sup>	00 h 00 min 02 s
10: Probe in PROCESS	00 h 00 min 05 s
11: Program End	

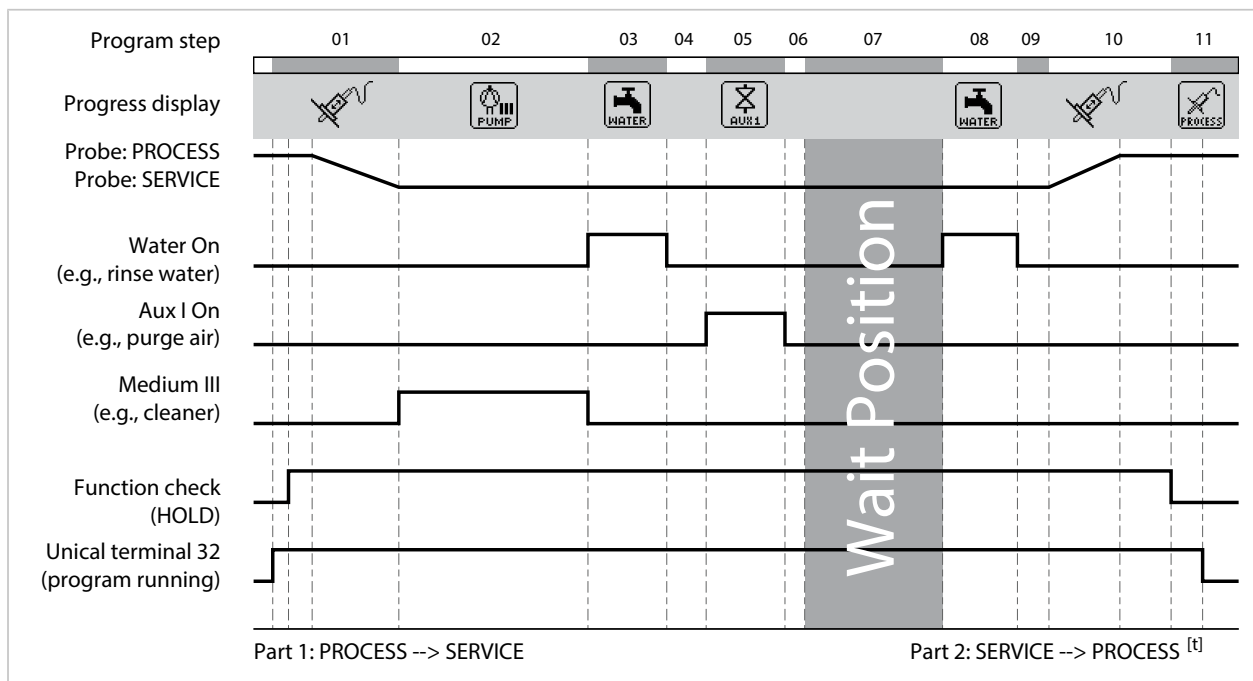

If the probe is to move from PROCESS to SERVICE, part 1 of the service program is executed. If the probe is to move from SERVICE to PROCESS, part 2 of the service program is executed.

<sup>1)</sup> Wait time after execution of the actual program step  
<sup>2)</sup> Media designation as configured → *Installation*, p. 62.

### 5.1.4 Configuring the Program Flow

Parameter Setting ▶ [...C] Unical ▶ Program Flow

All programs P1 ... P7 can be adjusted by the user.

Prerequisite: All relevant settings, e.g., selection of measurement procedure, designation of media, have been specified in the **Installation** submenu. → *Installation, p. 62*

01. Select the program.

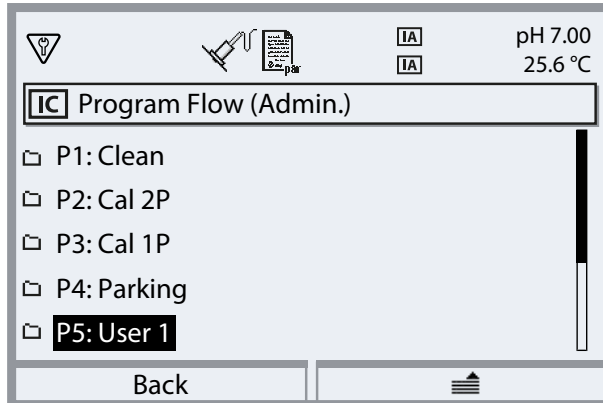

02. As required, select **right softkey**: "Rename" and press **enter**.

03. "Program Name": Use the **right arrow key** and **up/down arrow keys** to enter the desired program name and confirm by pressing **enter**.<sup>1)</sup>

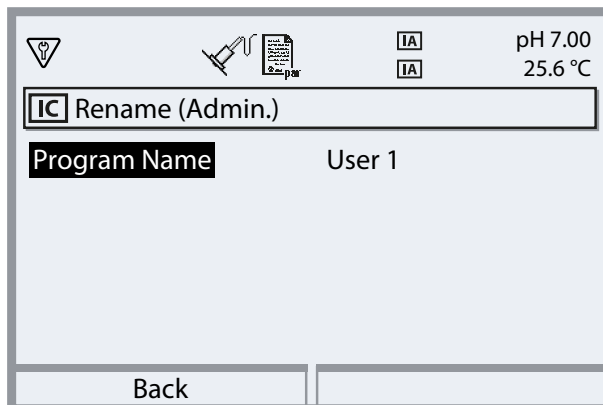

04. **Left softkey**: **Back**

05. Press **enter** or the **right arrow key** to open the program flow.

06. Compile the program steps with the **right softkey**: "Insert Before", "Insert After", "Delete", or "Delete All". Select with the **up/down arrow keys** and **enter**.

✓ A "Space" is added if you select "Insert Before" or "Insert After".

07. Select "Space" and open by pressing **enter** or the **right arrow key**.

08. Select the desired function with **enter** or the **right arrow key** and **up/down arrow keys**.

<sup>1)</sup> Sequence of alphanumeric characters:  
ABCDEFGHIJKLMNOPQRSTUVWXYZabcdefghijklmnopqrstuvwxyz0123456789.,+\_\*

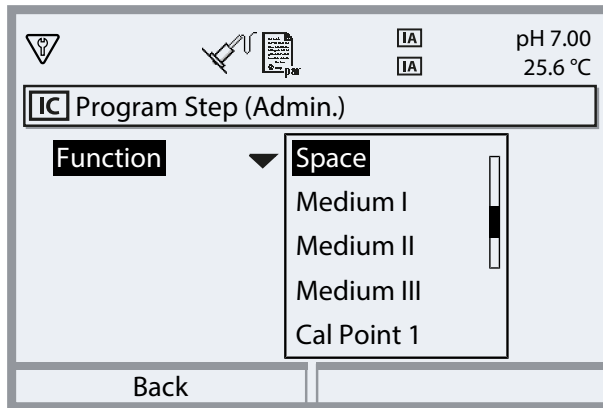

09. Configure the program step. Description of program steps → *Control and Service Programs*, p. 48

If monitoring has been set up for the medium in the menu

Parameter Setting ▶ [...C] Unical ▶ Installation, it can be switched on or off here.

10. When finished, open the program flow by pressing the **left softkey: Back** and add and configure further program steps.

**Note:** A program flow can consist of up to 30 program steps.

11. Complete the configuration by pressing the **left softkey: Back**.

### 5.1.5 Calibration

Parameter Setting ▶ [...C] Unical ▶ Calibration

#### Calibration Mode

Calimatic	The calibration buffers are detected automatically. Only the buffer set needs to be selected.
Buffer Entry	Selection of buffer set and buffer solution for calibration points 1 and 2.

#### Adjustment

Yes	After calibration, the system is adjusted, provided that the new adjustment data allow this.
No	Only calibration is performed; no change to the adjustment data.

For a description of calibration/adjustment, see the Protos module User Manual.

## 5.1.6 Installation

Parameter Setting ▶ [...C] Unical ▶ Installation

Submenu	Description, options
Measurement Procedure → <i>Measurement Procedure</i> , p. 62	Continuous, short-time
Manual Control Passcode	Access code for manual control (Protos Maintenance menu); Off, On (default: 2958)
External Control (PCS) → <i>External Control via Process Control System (PCS)</i> , p. 63	Program selection via PCS inputs on Unical: Polarity, Output Settings
Probe → <i>Probe</i> , p. 64	Selection and configuration of the retractable fitting
Immersion Lock → <i>Immersion Lock</i> , p. 62	Selection of different immersion locks: Sensor Removed, Sensor Not Connected, Sensocheck Glass Electrode
Rinse Medium	
• Medium	Enter the medium designation, e.g., "Water". <sup>1) 2)</sup>
• Monitoring → <i>Media Monitoring</i> , p. 66	Off, Process Value, Temperature
Media Adapter → <i>Media Adapter</i> , p. 65	Medium I... III
Additional Media → <i>Additional Media</i> , p. 65	Additional Medium Aux 1, Additional Medium Aux 2
Commissioning Program → <i>Commissioning Program</i> , p. 66	Start the commissioning program

### Measurement Procedure

Parameter Setting ▶ [...C] Unical ▶ Installation ▶ Measurement Procedure

- Continuous measurement: The sensor is in the process medium (probe in PROCESS) until it is moved into the fitting's calibration chamber (probe in SERVICE) when requested, e.g., for cleaning or calibration.
- Short-time measurement (interval measurement, sampling, sample mode ...): The sensor remains in the fitting's calibration chamber (probe in SERVICE) and is only moved into the process medium for a short time when requested.  
Short-time measurement is used when aggressive or thermally demanding process media are present and require short measuring times with long rest periods.

### Immersion Lock

Parameter setting ▶ [...C] Unical ▶ Installation ▶ Immersion Lock

Depending on the retractable fitting and sensor used, three immersion locks are available for selection.

On delivery, the immersion locks are switched off.

- Sensor Removed:  
When using the Ceramat retractable fitting with solid-electrolyte sensor, this mechanical immersion lock prevents the probe from moving into the process position without the sensor installed. For a description, see the Ceramat User Manual.
- Sensor Not Connected:  
This immersion lock prevents the probe from moving to the process position without a sensor connected. For this purpose, it is determined whether the temperature detector integrated in the sensor is connected or whether communication is taking place (digital sensors).

<sup>1)</sup> The designation entered here is used in all program flows and in the **Manual Control** menu to identify the corresponding valve.

<sup>2)</sup> Sequence of alphanumeric characters:  
ABCDEFGHIJKLMNOPQRSTUVWXYZabcdefghijklmnopqrstuvwxyz0123456789.,+\_\*

- **Sensocheck Glass Electrode:**

When using pH glass sensors, this immersion lock prevents the probe from moving into the process position with a broken sensor. For this purpose, the impedance of the glass membrane is monitored. As soon as the impedance exceeds a certain value, the message “Sad Sensoface Glass Impedance” is generated and the immersion lock is triggered.

**Note:** When activating the “Sensocheck Glass Electrode” function, make sure that the sensor does not run dry in the calibration chamber, as the glass impedance of the sensor will then be very high and trigger the immersion lock.

### External Control via Process Control System (PCS)

Unical can also be controlled via a process control system. This is done either via the COMPA3400-081 Protos module or via the control inputs (terminals 36 ... 43) on the Unical.

The use of the control inputs on the Unical must be activated on the Protos:

Parameter Setting > [...C] Unical > Installation > External Control (PCS)

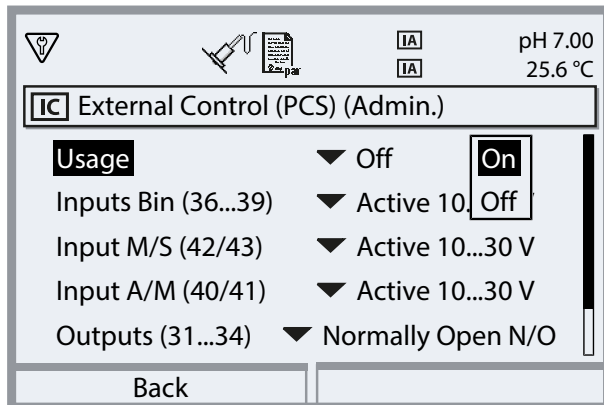

Submenu	Description
Usage	Off, on
Control Inputs (Terminals 36 ... 43): Definition of active signal level (< 2 V or 10 ... 30 V).	
Inputs Bin (36 ... 39)	Inputs for selection of control programs
Input M/S (42/43)	Input to start service mode M = measure (normal operation), S = service mode
Input A/M (40/41)	Input to enable automatic program start A = automatic, M = manual (locked)
Outputs (31 ... 34)	Check-back signals: Program Running, SERVICE position, PROCESS position Contact Type Terminals 31 ... 34: Normally open N/O, normally closed N/C
Output (31/34)	Terminal 31/34 signals: Probe in PROCESS or failure

Start the control programs → *Control and Service Programs, p. 48*

If external control via the process control system (PCS) is not used, the function should be deactivated to avoid conflicts:

Parameter Setting > [...C] Unical > Installation > Ext. Control (PCS) : Off

See also

→ *Process Control System Installation, p. 39*

## Probe

Parameter Setting > [...C] Unical > Installation > Probe

Submenu	Description, options
Probe Type	Selection of retractable fitting: Ceramat, SensoGate, other
Max. Travel Time	Enter the maximum travel time of the probe.  Input range: 0 ... 9999 s  If the maximum travel time is exceeded, the message "Maintenance Required" is generated. Unical first tries to jog the probe free by itself. If this does not succeed, the message "Failure" is generated.
Sealing Water	Sealing water is switched on shortly before the probe moves in order to keep the rinsing chamber free of media. This is important for processes with fibrous or adhering media. The sealing water pressure must be greater than the media pressure. The back pressure created by the sealing water in the rinsing chamber prevents the penetration of medium.  Off, on
Cavity Rinsing	For Ceramat: If the retractable fitting is in the process position (probe in PROCESS), the calibration chamber can be rinsed, e.g., to drain off penetrated process medium. For a description, see the Ceramat User Manual.  Off, Interval, Continuous
If "Interval" is selected:	
• Interval	Default setting: 1.0 h
• Rinse Time	Default setting: 5 s
Check Interval	Off, on
• Check after Strokes	Specification of the maximum permissible travel cycles until a message is triggered. Input range: 0 ... 99999  Default setting: 5000
Maintenance Interval	Off, on
• Maintenance after Strokes	Specification of the maximum permissible travel cycles until a message is triggered. Input range: 0 ... 99999  Default setting: 20000

The current counters can be viewed in the menu [Maintenance > \[...C\] Unical > Probe Wear](#). The check and maintenance counters can also be reset there. → *Probe Wear*, p. 77



## Media Adapter

The media adapter features three ports (Medium I ... III), which can be separately configured.

Parameter Setting ▶ [...C] Unical ▶ Installation ▶ Media Adapter ▶ Medium ...

Submenu	Description, options
Usage	Definition of equipment: Off, Metering Pump
Medium	Enter the medium designation, e.g., "Buffer 1" <sup>1) 2)</sup>  Ports I and II with the corresponding containers and tubing are designed for the use of calibration media. Port III with the corresponding container and tubing is designed for the use of cleaning media.
Displacement	The displacement depends on the retractable fitting (size of the calibration chamber).  Selection options: 25 ml, 50 ml, 75 ml, 100 ml  Recommended displacement: Ceram: 25 ml SensoGate: 50 ml
Residual Volume	Selection options: 0 ml, 250 ml, 500 ml  When there is still approx. 500 ml of liquid in the tank, a Maintenance Required message is generated. After this, the selected residual volume can still be pumped until a Failure message is generated.
Monitoring → <i>Media Monitoring</i> , p. 66	Off, Process Value, Temperature

See also

→ *Installing the Media Adapter with Metering Pumps and Containers*, p. 33

→ *Metering Pump: Filling the Containers*, p. 67

## Additional Media

Two different additional media can be connected and configured.

Parameter Setting ▶ [...C] Unical ▶ Installation ▶ Additional Media

Submenu	Description, options
<b>Additional Medium Aux 1</b>	
<b>Additional Medium Aux 2</b>	
Usage	Off, on
Medium	Enter the medium designation, e.g., "Purge Air" <sup>1) 2)</sup>
Monitoring → <i>Media Monitoring</i> , p. 66	Off, Process Value, Temperature

<sup>1)</sup> The designation entered here is used in all program flows and in the **Manual Control** menu to identify the corresponding valve.

<sup>2)</sup> Sequence of alphanumeric characters:  
ABCDEFGHIJKLMNOPQRSTUVWXYZabcdefghijklmnopqrstuvwxyz0123456789.,+\_\*

## Media Monitoring

For complete system control, the media used (buffer solutions, cleaning solution, rinse water, ...) can be monitored in the calibration chamber for compliance with a predefined process value or temperature. This ensures that the expected media also arrive in the calibration chamber of the retractable fitting. If mixed-up or corrupted media or media with the wrong temperature are detected, a message is triggered (U241 ... U245). → *Troubleshooting, p. 83*

Possible process values:

pH sensors	pH value
pH/ORP sensors	pH value
ORP Sensors	ORP

**Note:** When monitoring media for the pH value, zero point and slope changes of the sensor must be taken into account. The “permissible deviation” must therefore not be too low. The required minimum setting time is automatically taken into account when setting up the application programs.

Monitoring can be set for the following media:

- Rinse medium
- Media at media adapter (... in menu item “Media Adapter”)
- Additional media

The settings are made in the relevant installation menu:

Parameter Setting ▶ [...C] Unical ▶ Installation

**Note:** If “Monitoring: Off” is selected, all messages triggered so far are deleted.

## Commissioning Program

Last item in the “Installation” menu: Start the commissioning program after completing the configuration.

The previously configured pumps perform the number of stroke movements required to completely fill the media hoses. The necessary rinse cycles are initiated automatically.

## 6 Operation

Unical 9000 is controlled via the Protos industrial transmitter. Control via process control system  
→ *External Control via Process Control System (PCS), p. 63*

The calibration and cleaning media are manually filled into the containers of the metering pumps. The media are automatically supplied to the retractable fitting via the media connection.

The retractable fitting moves the sensor to the process position (probe in PROCESS) for measurement and to the service position (probe in SERVICE) for cleaning or calibration. Measured values and maintenance intervals are output on the industrial transmitter.

**Note:** More information on Knick industrial transmitters and retractable fittings can be found at  
→ [www.knick.de](http://www.knick.de).

See also

→ *External Control via Process Control System (PCS), p. 63*

### 6.1 Metering Pump: Filling the Containers

The metering pump is a wear-free and maintenance-free bellows pump. The containers are filled manually. During operation, the fill level is monitored automatically.

Three ports for the metering pumps are available on the media adapter.

Recommended	Calibration Medium	Cleaning Medium
Port I	x	
Port II	x	
Port III		x

#### Recommended Cleaning Media

**Note:** When selecting the cleaning medium, the resistance of the O-rings of the metering pumps, the media adapter, and the media connection must be taken into account.

Cleaning Medium	Chemical Designation	Maximum Concentration	Application	Seal	
				FKM	EPDM
<b>Diluted acids</b>					
Hydrochloric acid	HCl	Max. 5 %	Calcareous deposits	x	x
Sulfamic acid	H <sub>3</sub> NO <sub>3</sub> S		Calcareous deposits, food industry	x	x
Acetic acid	CH <sub>3</sub> COOH		Calcareous deposits		x
Nitric acid	HNO <sub>3</sub>	Max. 5 %	Calcareous deposits	x	x
<b>Diluted bases</b>					
Sodium hydroxide	NaOH	Max. 5 %	Proteins, starches, fats, CIP		x
<b>Organic solvents</b>					
Ethanol	C <sub>2</sub> H <sub>5</sub> OH		Fats, oils, food industry		x
Isopropanol	C <sub>3</sub> H <sub>8</sub> OH		Fats, oils	x	x
<b>Other cleaners</b>					
Pepsin solution			Proteins	x	x

**Note:** Cleaning media may contain different hazardous substances. Observe safety instructions.  
→ *Safety, p. 5*

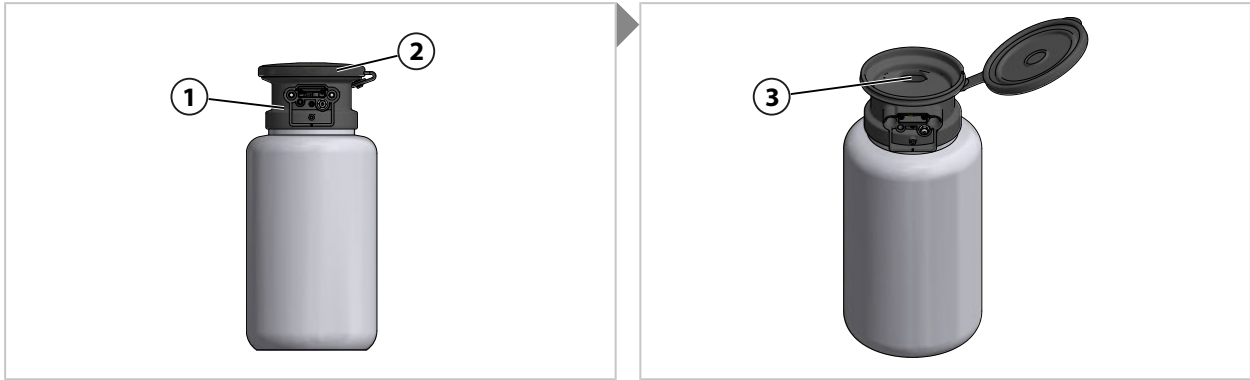

01. Open the top piece **(2)** on the metering pump **(1)**.

02. Fill calibration or cleaning medium into the opening **(3)**.

✓ Containers filled.

**Note:** The fill level can be seen through the semitransparent container.

## 6.2 Progress Display

Each new Unical activity, e.g., a program start, is displayed on Protos.

- If the measurement display or the measurement recorder is active, Protos switches to the progress display.
- If one of the menus (Cal, Maint, Par, or Diag) is open, the “Unical Active” icon is shown in the status line on Protos:



- If a Unical action has been triggered on Protos, e.g., manual program start, commissioning program, Protos also switches to the progress display.

The progress display can be activated at any time during operation by pressing the *meas* key several times.

Close the progress display with the *left softkey: Close*.

The following information is displayed:

If a Unical is not connected	<ul style="list-style-type: none"> <li>• Message: “No Connection to Unical”</li> </ul>
While a program is running (see below for display example.)	<ul style="list-style-type: none"> <li>• Program</li> <li>• Program step</li> <li>• Progress bar</li> <li>• Active Unical assembly group</li> </ul>
During processing of calibration steps	<ul style="list-style-type: none"> <li>• Sensor-dependent measured values (e.g., for pH sensor: pH buffer value, pH voltage, temperature, response time)</li> </ul>
If a program is not running	<ul style="list-style-type: none"> <li>• Sensor position: Probe in SERVICE or PROCESS</li> <li>• Message: “Immersion Lock” if one of the three possible causes is detected → <i>Troubleshooting, p. 83</i></li> <li>• The next program to be executed by time control or the calibration timer and its execution time</li> </ul>
During service mode (see below for display example.)	<ul style="list-style-type: none"> <li>• Trigger of service mode: Protos, service switch, or process control system (PCS)</li> <li>• Message: “Immersion Lock” if one of the three possible causes is detected → <i>Troubleshooting, p. 83</i></li> <li>• Last primary and temperature measured value (measured before the start of the function check) of the sensor connected to Unical, depending on the sensor type</li> </ul>
For short-time measurement, while Unical is in standby (probe in SERVICE position).	<ul style="list-style-type: none"> <li>• Info text: “Short-time Measurement – Standby”</li> <li>• Last primary and temperature measured value (measured before the start of the function check) of the sensor connected to Unical, depending on the sensor type</li> </ul>

Example of a progress display while a program is running:

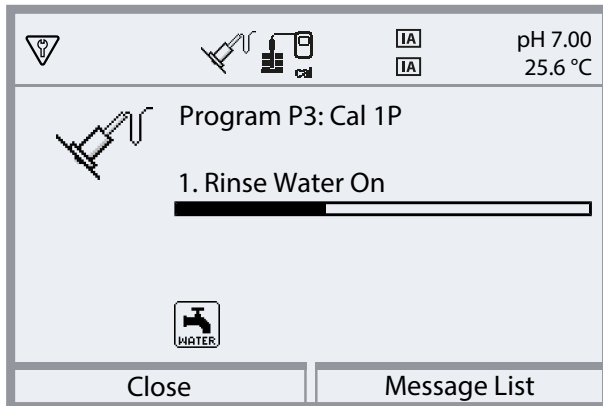

Example of a progress display during service mode:

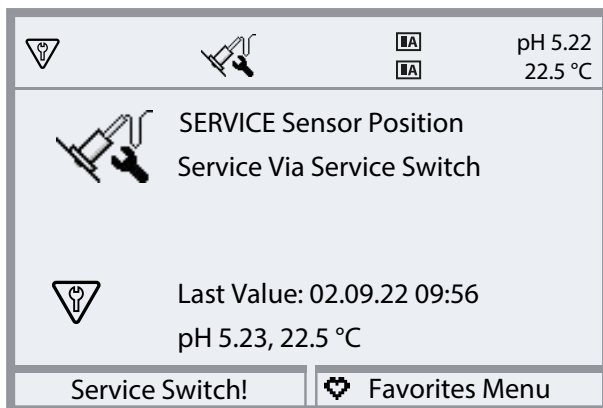

## 7 Diagnostics

### 7.1 Protos Diagnostic Functions

The Diagnostics menu shows various information on the status of the measuring system without interrupting the measurement.

See the User Manual for a detailed description of the diagnostic functions of the Protos II 4400 industrial transmitter.

#### Message List

Menu Selection ▶ Diagnostics ▶ Message List

All active error messages are displayed in the Message List menu item with the following information: message number, message type (NAMUR symbol), channel, message text.

An overview of error messages with notes on troubleshooting can be found in the “Troubleshooting” chapter. → *Troubleshooting, p. 83*

A full overview of all messages, showing the message types and signaling options, can be found in the annex. → *Overview of Unical Messages, p. 108*

#### Unical 9000 Diagnostic Functions

Menu Selection ▶ Diagnostics ▶ MSU4400-180 Module ▶ [...C] Unical

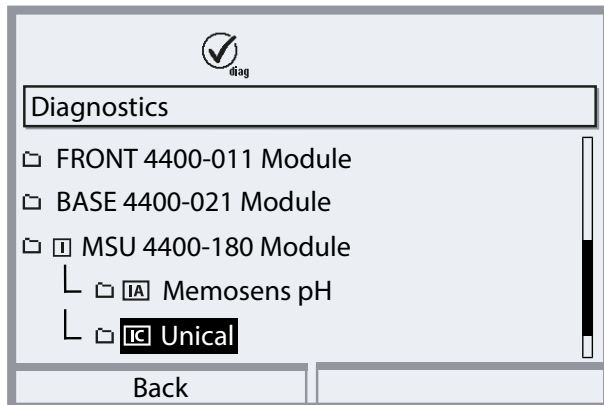

Submenus:

Unical Information	Display of device type, serial no., firmware version, hardware version
Unical Status	Display of communication status, flash checksum, compressed air, water pressure, media (depending on configuration)
Unical Sensor Diagram	Graphical display of compressed air, water pressure, media levels, probe travel time.

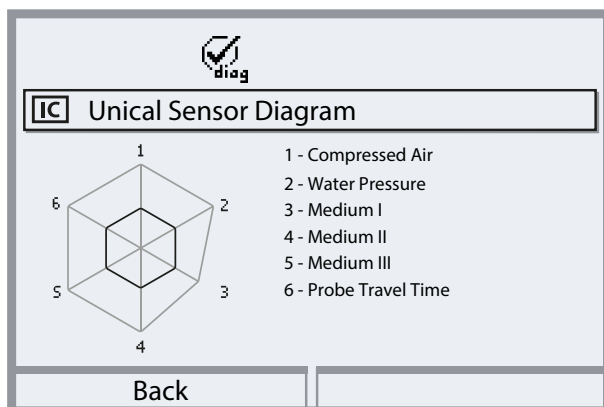

The parameter values should lie between the outer (100 %) and inner (50 %) polygon. A warning signal blinks if a value drops below the inner polygon (< 50 %).

## 7.2 Relay Contacts

For more detailed information and notes on wiring, see the Protos II 4400 basic unit User Manual.

The BASE Protos module provides 4 relay contacts (max. AC/DC rating 30 V / 3 A each).

The following settings are possible for all contacts:

Switching behavior (contact type):

- Normally open contact: the relay contact closes when it is activated.
- Normally closed contact: the relay contact opens when it is activated.

ON/OFF delays can also be configured.

Contact K4 is provided for the failure message.

Contacts K1 ... K3 can be assigned a use:

Parameter Setting ▶ BASE Module ▶ Contact K... ▶ Usage

### Use of Relay Contacts

- Off
- Failure
- Maintenance required
- Out of specification
- Function check
- Limit
- Rinse contact
- Rinse contact (channel) (A single measuring channel can be selected here.)
- USP output (only when using a conductivity module)
- Sensoface
- Sensoface (channel) (A single measuring channel can be selected here.)
- Unical (only when using an MSU4400-180 module)

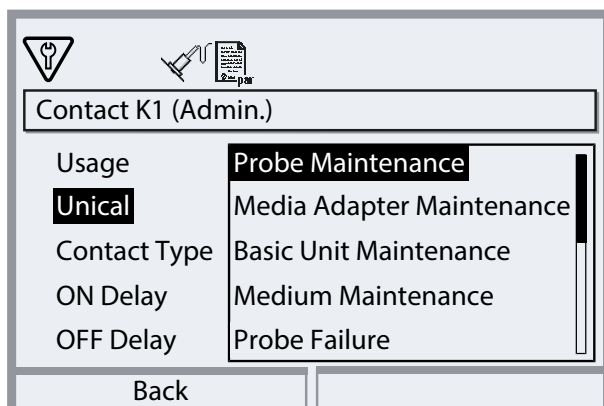



**Settings When Using “Unical”**

<b>Selection</b>	<b>Associated message</b>	
Probe Maintenance	U231	Probe PROCESS Travel Time
	U234	Probe SERVICE Travel Time
Media Adapter Maintenance	U190	Container I Almost Empty
	U191	Container II Almost Empty
	U192	Container III Almost Empty
Unical Basic Unit Maintenance	U229	Sensor Dismount Guard Defective
	U233	Water Pressure Sensor
	U235	Safety Valve Defective
	U248	Water Valve Defective
Medium Maintenance	U241	Rinse Medium Monitoring
	U242	Medium I Monitoring
	U243	Medium II Monitoring
	U244	Medium III Monitoring
	U245	Aux 1 Monitoring
	U246	Aux 2 Monitoring
Probe Failure	U227	Probe SERVICE Limit Position
	U230	Probe PROCESS Limit Position
Media Adapter Failure	U194	Container I Empty
	U195	Container II Empty
	U196	Container III Empty
Unical Basic Unit Failure	U217	Immersion Lock: Sensor Not Connected
	U218	Immersion Lock: Sensocheck Glass Electrode
	U220	Compressed Air Sensor
	U221	Immersion lock
	U224	Leakage Sensor
	U225	Probe Valve Defective
Calibration Error	U251	Calibration Error pH
	U255	Calibration Error ORP
Unical Failure	U252	Communication Error

By selecting **Parameter Setting** ▶ **BASE Module** ▶ **Contact K...** ▶ **Usage** : “Failure” or “Maint. Required,” all other failure or maintenance required messages can also be signaled via a relay contact.

## 8 Maintenance

### 8.1 Inspection and Maintenance

#### 8.1.1 Protos Maintenance Functions

See the User Manual for a detailed description of the maintenance functions of the Protos II 4400 industrial transmitter.

#### Unical 9000 Maintenance Functions

Menu Selection ▶ Maintenance ▶ [...C] Unical

**Note:** Function check (HOLD) is active. The current outputs and relay contacts behave in accordance with the parameter settings. Return to measuring mode to exit the function check, e.g., with the *Meas* key.

The Maintenance menu provides various functions for checking the function of Unical:

Submenus	Description
Start Program → <i>Start Program</i> , p. 74	Start a program flow for test purposes.
Start Unical Service or End Unical Service	Activate or end service mode. → <i>Service Mode</i> , p. 74
Manual Control → <i>Manual Control</i> , p. 75	Actuation of the Unical 9000 electro-pneumatic controller for service purposes.
Probe Wear → <i>Probe Wear</i> , p. 77	Display of information on possible retractable fitting wear, resetting of check and maintenance counters.

#### Start Program

Regardless of whether Unical is in service mode, a program can be run for test purposes.

Exception: The retractable fitting has been moved to the service position via the service switch.

With the exception of the service program, all available programs can be selected. Before starting, a confirmation prompt must be confirmed.

If the program has been started successfully, the program progress window is displayed.

#### Service Mode

Service mode represents a type of safety state in which, for example, the sensor can be installed or removed. In service mode, the retractable fitting is always in the service position (probe in SERVICE), regardless of the selected measurement procedure.

The transition to service mode always starts with moving the retractable fitting – if it is not already in the service position – to the service position by means of the service program. The retractable fitting is only moved to the process position in the “Continuous” measurement procedure or left in the service position in the “Short-time” measurement procedure when none of the possible sources requests service mode. If necessary, the compressed air is switched on again.

**Note:** Before the retractable fitting moves to the service position (probe in SERVICE), the function check (HOLD) for the assigned sensor channel is activated. The current outputs and relay contacts behave in accordance with the parameter settings. Function check (HOLD) is ended when the retractable fitting is again in the process position (probe in PROCESS).

The behavior of the PROFIBUS interface is set out in the User Manual for the COMPA3400-081 Protos module.

In general, no programs start automatically in service mode.

Service mode can be triggered in various ways:

- By the service switch
- By Protos: Maintenance ▶ Unical ▶ Start Unical Service
- By Protos softkey: Function assignment in the menu  
Parameter Setting ▶ System Control ▶ Function Control
- Via the PCS inputs on Unical
- Via PROFIBUS, e.g., with the COMPA3400-081 Protos module

In service mode with the service switch:

- The safety valve depressurizes the pilot valves.
- No program start possible, either manually or by the process control system or PROFIBUS (COMPA3400-081 module).
- No queue for program starts.
- The queue is deleted.
- Any running program is aborted.

In all other cases:

- Manual program start possible by process control system or in Protos Maintenance menu.  
→ *Start Program, p. 74*
- Automatic program starts are collected in a queue until all service requests are canceled.
- Any running program is aborted.
- The queue is retained.

## Manual Control

Manual control via Protos II 4400 enables actuation of the Unical 9000 electro-pneumatic control system for service purposes. Rinse water, media supply, and valve functions can be tested individually. In addition, the probe can be moved to the SERVICE and PROCESS positions.

**NOTICE!** Unpredictable system reactions possible. The safety functions are switched off. Manual control may only be carried out by trained personnel. If in doubt, disconnect the retractable fitting from the process.

On delivery, the menu is protected by a passcode that can be changed or deactivated in the configuration:

Parameter Setting ▶ Unical ▶ Installation → *Installation, p. 62*

Behavior of the system during manual control:

- Program starts are queued.
- Any running program is aborted when entering manual control.
- The service switch keeps its function. Pressing the service switch is signaled by the following display text: "Service Via Service Switch".

Functions:

- Fill level monitoring status display: Indicates how many pump movements are still possible after the float threshold has been reached. Unical will still pump if the value falls below the limit.
- Open the message list using the **right softkey**.
- Actuation of individual valves. The corresponding function is indicated by icons.

## Performing Manual Control

01. Maintenance ▶ [...C] Unical ▶ Manual Control
02. Enter the passcode and press **enter** to confirm.

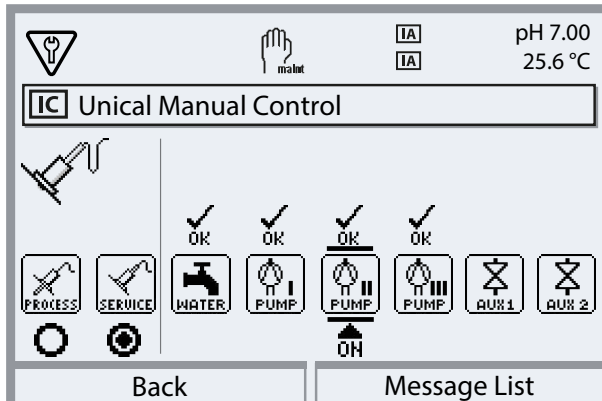

03. Select the function using the arrow keys.
  - ✓ The relevant icon blinks.
04. Activate the function by pressing **enter**.
  - ✓ "ON" appears under the icon.
05. End the function by pressing **enter**.
  - ✓ "ON" goes out. The error-free function is indicated by "OK" above the icon. If the function is faulty, an error message is generated.
06. Exit manual control with the **left softkey: Back**.

After exiting manual control, the system asks whether Protos should start a Unical service.

Since an undefined state may exist due to the manual control, it is strongly recommended that you start a Unical service after manual control by confirming with "Yes".

See also

→ *Installation, p. 62*

## Probe Wear

Maintenance ▶ [...C] Unical ▶ Probe Wear



The following is displayed:

- Total probe travel = total number of travel movements performed by the retractable fitting
- Check counter
- Maintenance counter

Check and maintenance counters are permanently switched on. The intervals until a message is triggered are set up in the configuration:

Parameter Setting ▶ [...C] Unical ▶ Installation ▶ Probe → *Installation, p. 62*

The counters can be reset in the **Probe Wear** menu.

		IA	pH 7.00
		IA	25.6 °C
<b>IC</b> Probe Wear (Admin.)			
Total Probe Strokes	12		
Check Counter	60		
Maintenance Counter	100		
<b>Reset Check Counter</b>		▼	No
Reset Maintenance Counter		▼	No
Back		Reset	

See also

→ *Installation, p. 62*

### 8.1.2 Pilot Valve Functional Test

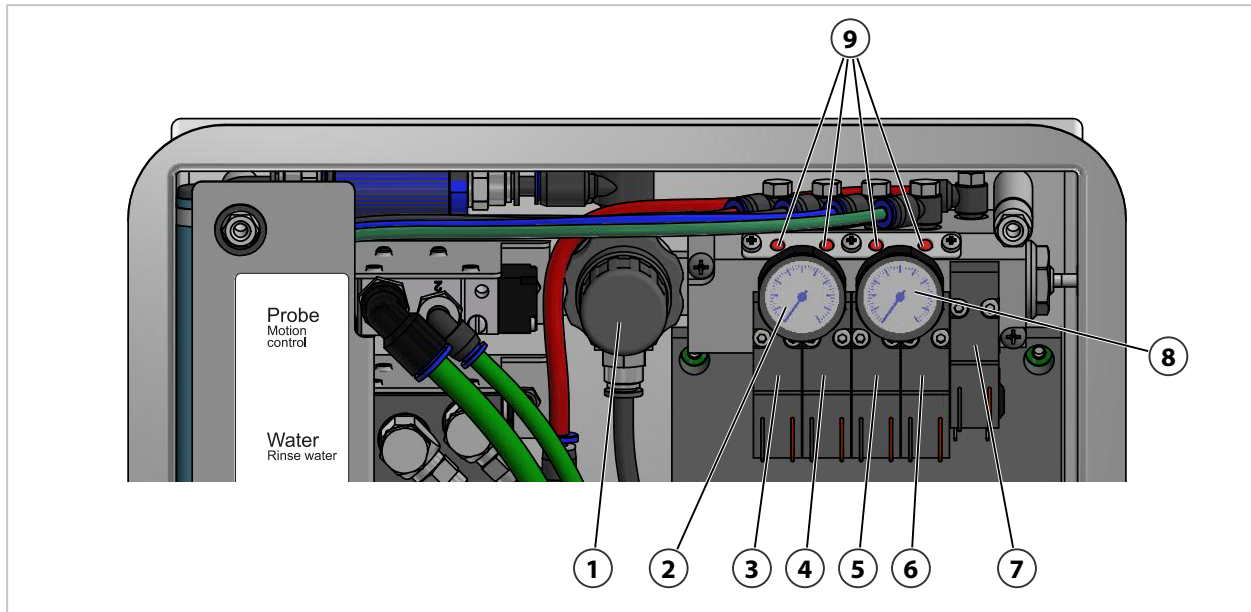

- |   |  |
|---|--|
| 1 Pressure regulator                    | 6 Process and service position pilot valve |
| 2 Manometer: operating pressure display | 7 Safety valve                             |
| 3 Option: Aux 2 pilot valve             | 8 Manometer: pilot valve pressure display  |
| 4 Option: Aux 1 pilot valve             | 9 Red pins                                 |
| 5 Water pilot valve                     |  |

When the pilot valve is active, the red pin protrudes from the valve block. The protruding red pin indicates that the pilot valve is functioning.

## 8.2 Corrective Maintenance

### 8.2.1 Corrective Maintenance on the Metering Pumps

The metering pumps with containers must be cleaned; O-rings or seals must be replaced if necessary:

- When changing the media
- When using aggressive cleaning media
- In accordance with internal operating regulations

**Note:** Cleaning media may contain different hazardous substances. Observe safety instructions.  
→ *Safety, p. 5*

#### Cleaning Metering Pumps and Containers

**Note:** When replacing media, make sure that there are also media in the media connection and in the retractable fitting. Protect the Sub-D socket **(10)** from dirt and moisture.

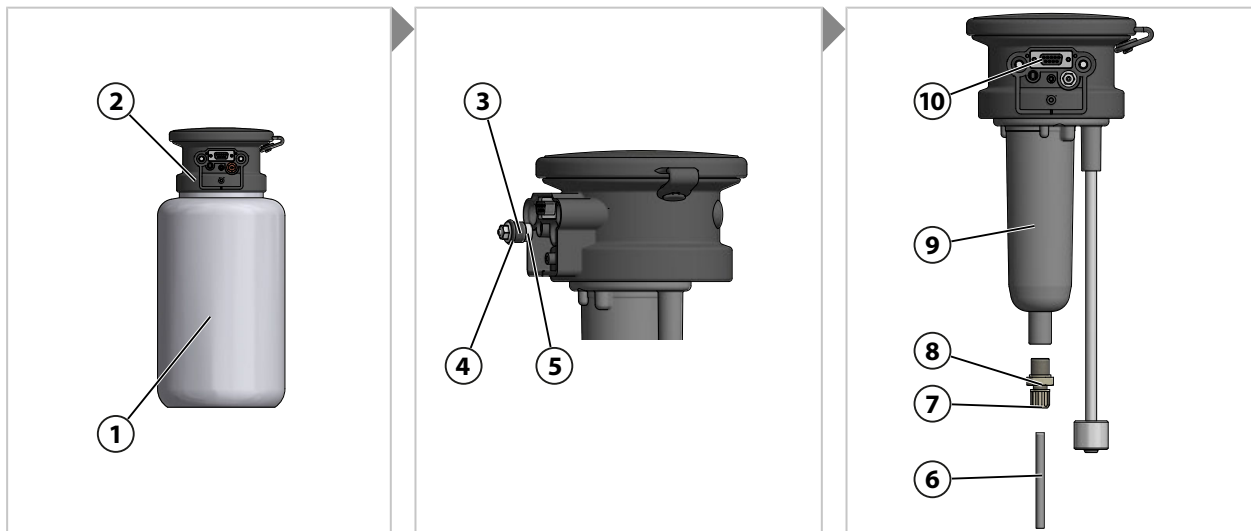

01. Unscrew the container **(1)** from the pump head **(2)**.
02. Empty the container in compliance with local operating regulations, rinse and, if necessary, dispose of medium.
03. Remove and clean the check valve **(3)** (A/F 8). Replace with ZU0933 if necessary.  
→ *Accessories, p. 93*
04. Check the O-ring 10 x 1.5 mm **(4)**, and O-ring 5 x 1.5 mm **(5)** for damage. Replace if necessary.
05. Remove the coupling **(7)** and the suction tube **(6)**.
06. Disconnect the check valve **(8)** (A/F 17) from the pump housing **(9)** and clean. Replace with ZU0933 if necessary → *Accessories, p. 93*
07. Behind the check valve **(8)** there is a ball, spring, and O-ring 6 x 1.5 mm; replace the O-ring if necessary.
08. Screw the check valve **(8)** tightly to the pump housing **(9)**.
09. Insert the suction tube **(6)** into the check valve **(8)** and firmly tighten the coupling **(7)**.
10. Screw the check valve **(3)** into the pump head **(2)**.
11. Screw the container **(1)** to the pump head **(2)**.  
✓ Metering pump cleaned and O-rings replaced.

## Replacing Seals

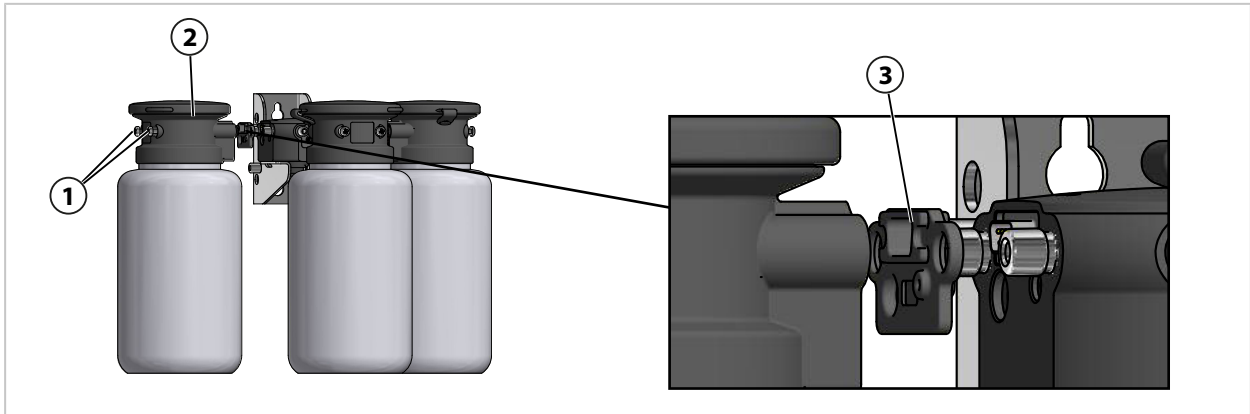

01. Remove the screws **(1)** from the metering pump **(2)**.
02. Remove the seal **(3)** and replace with ZU0369. → *Accessories, p. 93*  
✓ Seal replaced.



03. Unscrew the container **(1)** from the pump head **(2)**.
04. Push the fill level monitoring device **(3)** up and replace the O-ring **(4)** 6.5 x 3 mm.
05. Screw the container **(1)** to the pump head **(2)**.  
✓ O-ring replaced.



## 8.2.2 Replacing the Air Pressure Switch

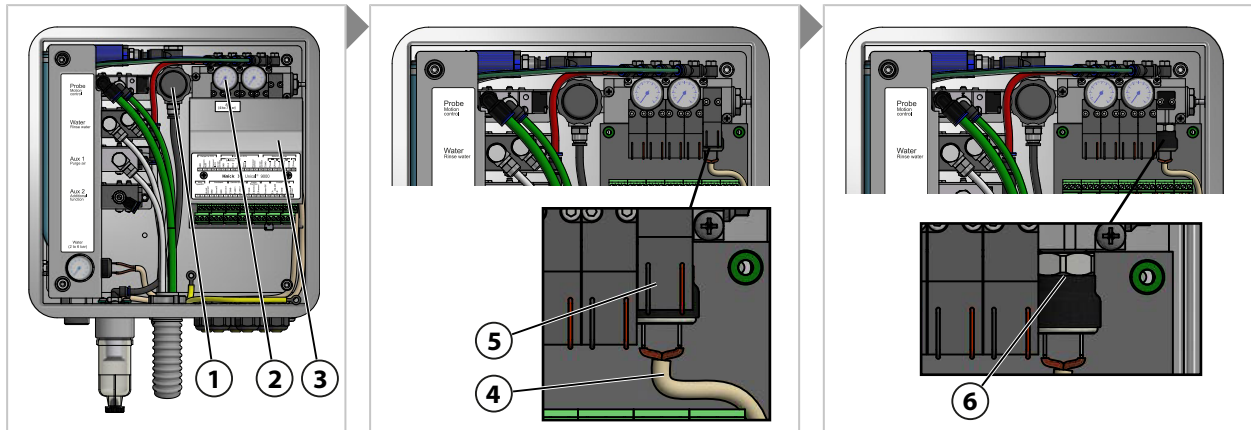

01. Shut off the compressed air supply.
02. Turn the pressure regulator down counterclockwise **(1)** until the manometer **(2)** shows 0 bar.
03. Unscrew the cover **(3)**.
04. Remove the cable **(4)** from the pressure switch **(6)**.
05. As required, remove the safety valve **(5)**.
06. Using an open-end wrench A/F 17, remove the pressure switch **(6)** and replace with ZU0632.  
→ Accessories, p. 93
07. Fasten the cable **(4)** on the pressure switch **(5)**.
08. As required, install the safety valve **(5)**.
09. Screw on the cover **(3)**.
10. Open the compressed air supply.
11. Set the pressure regulator **(1)** to the desired pressure  $\geq 4$  bar (58 psi).  
✓ Air pressure switch has been replaced.

### 8.2.3 Replacing the Water Pressure Switch

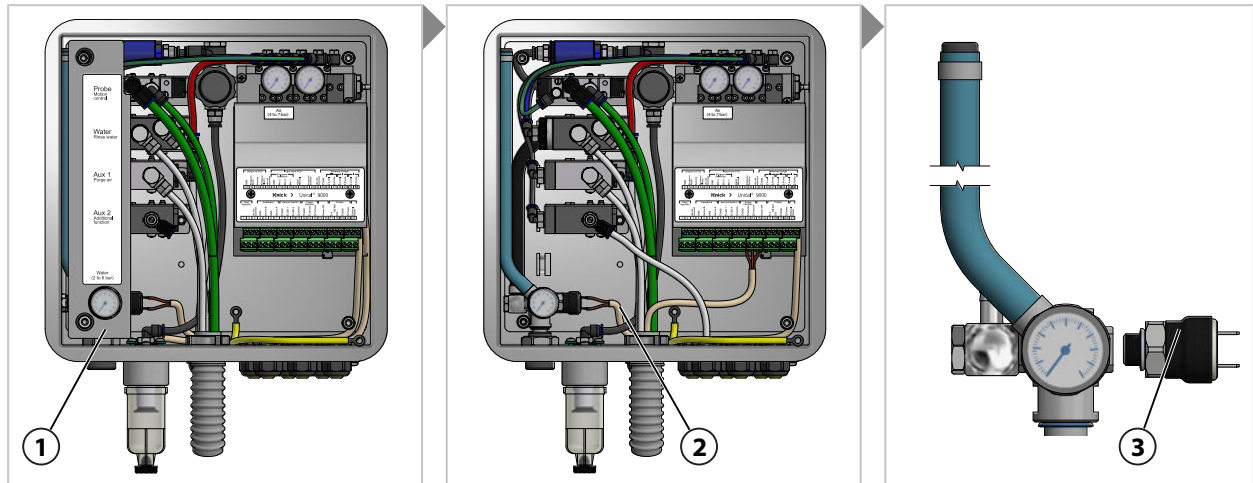

01. Shut off the water supply.
02. Operate the water valve on Protos to relieve the pressure in the water lines. [Maintenance](#) ▶  
[...C] [Unical](#) ▶ [Manual Control](#)
03. Pull off the cover **(1)**.
04. Remove the cable **(2)** from the pressure switch **(3)**.
05. Using an open-end wrench A/F 17, remove the pressure switch **(3)** and replace with ZU0633.  
→ *Accessories, p. 93*
06. Connect the cable **(2)** to the pressure switch **(3)**.
07. Fit the cover **(1)**.
08. Open the water supply.  
✓ Water pressure switch has been replaced.

### 8.2.4 Knick Repair Service

The Knick Repair Service offers professional corrective maintenance for the product to the original quality. Upon request, a replacement unit can be obtained for the period of the repair.

Further information can be found at [www.knick.de](http://www.knick.de).

## 9 Troubleshooting

### Displaying Messages

01. Go to the Diagnostics menu if the “Failure” ☒ or “Maintenance Required” ⚠ icons blink on the display: **Menu Selection ▶ Diagnostics ▶ Message List**
- ✓ All active messages are displayed in the **Message List** menu item with the following information: Message number, message type (NAMUR symbol), channel, message text.
02. Scroll forward and backward using the **up/down arrow keys**.

The error message disappears from the display around 2 s after the error is cleared.

Error	Error Message / Malfunction State	Possible Cause (Triggered By)	Remedy
U190	Container I Almost Empty	Residual volume reached or not reached.	Refill medium.
U191	Container II Almost Empty		
U192	Container III Almost Empty	Container leaking. Container is leaking or damaged.	Replace the container.
U194	Container I Empty		
U195	Container II Empty		
U196	Container III Empty		
		Check-back defective, cable interrupted or short-circuited.	Check the Unical media adapter connection; reconnect if necessary.
		Float switch stuck. <sup>1)</sup>	Check the float switch's movement. Replace if necessary.
U217	Sensor Not Connected: Immersion Lock Triggered.	No sensor connected (transmitter)	Connect a sensor
U218	Sensocheck Glass Electrode: Immersion Lock Triggered.	Glass membrane impedance too high.	Replace sensor. As applicable, adjust glass impedance.
		Faulty sensor. Sensor glass shattered.	Check the sensor for glass breakage and replace if necessary.
		Sensor cable defective. <sup>2)</sup>	Check the sensor cable and replace if necessary.
		Sensor dried out in calibration chamber.	Water the sensor. If necessary, replace the sensor. If necessary, adjust the program flow.
U219	Firmware Error	Error in the firmware	Switch Protos off (approx. 10 s). Reload the firmware. <sup>3)</sup> If the message persists, send in the device. → <i>Knick Repair Service, p. 82</i>
U220	Compressed Air Sensor	Compressed air failed.	Restore the external compressed air supply. → <i>Specifications, p. 99</i>
		Pressure too low < 2 bar	Increase the pressure. → <i>Specifications, p. 99</i>
U221	Immersion Lock	Retractable fitting immersion lock active. <sup>4)</sup> (sensor dismount guard)	Remove and reinstall the sensor. As necessary, check the tightening torque. <sup>5)</sup>
U222	Undefined Safety State	Power failure	Press the service switch twice.

<sup>1)</sup> The error message remains when the container is filled.

<sup>2)</sup> Only with analog sensors

<sup>3)</sup> Refer to the User Manual for the industrial transmitter.

<sup>4)</sup> Only when using the Ceramat retractable fitting

<sup>5)</sup> Refer to the User Manual for the retractable fitting.

<b>Error</b>	<b>Error Message / Malfunction State</b>	<b>Possible Cause (Triggered By)</b>	<b>Remedy</b>
U224	Leakage Sensor	Water in Unical (leakage sensor)	<p>Check the tightness of the internal water connections. → <i>Installing the Retractable Fitting and Media Adapter Supply</i>, p. 27</p> <p>Check the leakage sensor for moisture. Dry if necessary.</p> <p>During first-time installation, check the water and compressed air connection. → <i>Water Supply Installation</i>, p. 31 → <i>Compressed Air Supply Installation</i>, p. 32</p> <p>If the connections are reversed, return the product. → <i>Knick Repair Service</i>, p. 82</p>
		Hoses leaking.	Check the water connection for cleaning and rinsing. → <i>Installing the Retractable Fitting and Media Adapter Supply</i> , p. 27
U225	Unical Probe Valve Faulty	Pilot valve does not switch. (control)	<p>Switch the retractable fitting to manual mode. Check the pilot valve function. → <i>Pilot Valve Functional Test</i>, p. 78. As required, replace the process and service position pilot valve with ZU0638. → <i>Accessories</i>, p. 93</p>
		Valve for retractable fitting does not switch. (control)	<p>Depressurize the system. Release the compressed air. Remove the process and service position connections from the valve. → <i>Installing the Retractable Fitting and Media Adapter Supply</i>, p. 27 Switch the retractable fitting to manual mode. If the valve does not switch, replace it with ZU0634. → <i>Accessories</i>, p. 93</p>
U227	Probe SERVICE Limit Position	Retractable fitting does not reach the limit position. (deposits due to process)	Depressurize the media connection. Remove the retractable fitting and remove deposits.
		Retractable fitting does not reach the limit position. (compressed air)	Increase the compressed air if necessary. → <i>Specifications</i> , p. 99
		Position switch faulty.	Contact Knick support. → <a href="mailto:support@knick.de">support@knick.de</a>
U228	Probe Leaking	Connection between media connection and retractable fitting leaking. (sensor dismount guard)	<p>Check the connection between the media connection and retractable fitting. → <i>Installing the Media Adapter with Metering Pumps and Containers</i>, p. 33 Tighten screws. If necessary, replace the multiplug seal kit. ZU0812 and ZU1067 → <i>Accessories</i>, p. 93</p>
		Media connection leaking. (sensor dismount guard)	Check the tightness of the media connection. If necessary, replace the media connection.
U229	Sensor Dismount Guard Defective	Sensor dismount guard does not switch. (sensor dismount guard)	Contact Knick support. → <a href="mailto:support@knick.de">support@knick.de</a>

<b>Error</b>	<b>Error Message / Malfunction State</b>	<b>Possible Cause (Triggered By)</b>	<b>Remedy</b>
U230	Probe PROCESS Limit Position	Retractable fitting does not reach the limit position. (deposits due to process)	Depressurize the media connection. Remove the retractable fitting and remove deposits.
		Retractable fitting does not reach the limit position. (compressed air)	Increase the compressed air if necessary. → <i>Specifications, p. 99</i>
		Position switch faulty.	Contact Knick support. → <a href="mailto:support@knick.de">support@knick.de</a>
U231	Probe PROCESS Travel Time	Retractable fitting is sluggish. (deposits due to process)	Depressurize the media connection. Remove the retractable fitting and remove deposits.
		Seal kits in the retractable fitting faulty. (retractable fitting)	Depressurize the media connection. Remove the retractable fitting and replace the seals.
		Max. travel time of retractable fitting in industrial transmitter exceeded. Preset 6 s. (transmitter)	Increase the max. probe travel time. <a href="#">Parameter Setting</a> ▶ <a href="#">[...C] Unical</a> ▶ <a href="#">Installation</a>
		Supply pressure too low.	Increase the pressure if necessary. → <i>Specifications, p. 99</i>
		Pressure regulator set too low.	Set a higher pressure if necessary. → <i>Specifications, p. 99</i>
U233	Water Pressure Sensor	Water pressure < 1.2 bar. (water pressure switch)	Check the water pressure on the manometer; increase the pressure if necessary. → <i>Specifications, p. 99</i> Check the water supply.
		Water pressure switch faulty. (water pressure switch)	Change the water pressure on the manometer. If no change on display, replace the water pressure switch with ZU0633. → <i>Replacing the Air Pressure Switch, p. 81</i> If necessary, check the water manometer by depressurizing the supply line.
U234	Probe SERVICE Travel Time	Retractable fitting is sluggish. (deposits due to process)	Depressurize the media connection. Remove the retractable fitting and remove deposits.
		Seal kits in the retractable fitting faulty. (retractable fitting)	Depressurize the media connection. Remove the retractable fitting and replace the seals.
		Max. travel time of retractable fitting in industrial transmitter exceeded. Preset 6 s. (transmitter)	Increase the max. probe travel time. <a href="#">Parameter Setting</a> ▶ <a href="#">[...C] Unical</a> ▶ <a href="#">Installation</a>
		Supply pressure too low.	Increase the pressure if necessary. → <i>Specifications, p. 99</i>
		Pressure regulator set too low.	Set a higher pressure if necessary. → <i>Specifications, p. 99</i>
U235	Safety Valve Defective	No pressure drop in the pressure switch after pressing the service switch.	Check the pilot pressure manometer to see whether the pressure drops after the service switch is pressed. If there is no pressure drop, replace the safety valve. If the pressure drops, reduce the operating pressure at the pressure regulator.

Error	Error Message / Malfunction State	Possible Cause (Triggered By)	Remedy
U236	Metering Pump I Parameter Setting	Incorrect configuration, e.g., unused port configured as metering pump.	Check and, as necessary, correct the configuration. <a href="#">Parameter Setting</a> ▶ <a href="#">[...] Unical</a> ▶ <a href="#">Installation</a>
U237	Metering Pump II Parameter Setting		
U238	Metering Pump III Parameter Setting		
		Cable connection between media adapter and controller is interrupted.	Check the terminal assignments at the electro-pneumatic controller. → <i>Electrical Installation</i> , p. 34
		Metering pump not connected to media adapter.	Check the connection of the metering pumps at the media adapter. → <i>Installing the Media Adapter with Metering Pumps and Containers</i> , p. 33
U239	Aux 1 Parameter Setting	Incorrect configuration, e.g., unused port configured as auxiliary valve Aux 1 or Aux 2.	Check and, as necessary, correct the configuration. <a href="#">Parameter Setting</a> ▶ <a href="#">[...] Unical</a> ▶ <a href="#">Installation</a>
U240	Aux 2 Parameter Setting		
		Cable connection between pilot valve and wiring is interrupted.	Check the terminal assignments under the terminal cover. → <i>Electrical Installation</i> , p. 34
U241	Rinse Medium Monitoring	Incorrect medium in container.	Replace the medium. → <i>Metering Pump: Filling the Containers</i> , p. 67
U242	Medium I Monitoring	Buffer medium is obsolete. pH value is no longer reached.	Replace the medium. → <i>Metering Pump: Filling the Containers</i> , p. 67
U243	Medium II Monitoring		
U244	Medium III Monitoring		
U245	Aux 1 Monitoring		
U246	Aux 2 Monitoring		
		Configuration of the permissible deviation is incorrect.	Check and, as necessary, correct the configuration. <a href="#">Parameter Setting</a> ▶ <a href="#">[...] Unical</a> ▶ <a href="#">Installation</a>
		Medium is not sufficiently displaced.	
U248	Water Valve Defective	Cable connection between pilot valve and controller is interrupted.	Check the terminal assignments under the terminal cover. → <i>Electrical Installation</i> , p. 34 Check the pilot valve function. If necessary, replace the pilot valve. → <i>Pilot Valve Functional Test</i> , p. 78
U249	Probe Check Counter	The check counter stored in the program has expired. (transmitter)	Carry out check according to operational specifications. Reset the counter. <a href="#">Maintenance</a> ▶ <a href="#">[...] Unical</a> ▶ <a href="#">Probe Wear</a>
U250	Probe Maintenance Counter	The maintenance counter stored in the program has expired. (transmitter)	Carry out maintenance according to operational specifications. Reset the counter. <a href="#">Maintenance</a> ▶ <a href="#">[...] Unical</a> ▶ <a href="#">Probe Wear</a>

Error	Error Message / Malfunction State	Possible Cause (Triggered By)	Remedy
U251	Calibration Error pH	Identical buffers used. <sup>1)</sup>	Check calibration. If necessary, replace the buffer.
		Buffer unknown. <sup>1)</sup>	Check calibration. If necessary, replace the buffer.
		Buffer order differs from specified order. <sup>2)</sup>	
		Zero point/slope out of permissible range.	Check calibration. If necessary, adjust the limits.
		Calibration temperature out of permissible range.	Check calibration. If necessary, adjust the limits.
		Sensor worn/faulty.	Check sensor. If necessary, replace the sensor.
		Sensor cable faulty.	Replace the sensor cable.
U252	Communication Error	Unical is incorrectly or not connected to the Protos module.	Check the connection and, if necessary, reconnect. → <i>Electrical Installation, p. 34</i>
		Incorrect configuration.	Check and, as necessary, correct the configuration.
		Unical or Protos module faulty.	Return the device.
U253	Control Configuration	Unical is connected. Configuration in Protos is Unclean..	Adjust the configuration.
U255	Calibration Error ORP	Calibration temperature out of permissible range	Check the calibration temperature. If necessary, adjust the limits.
		Sensor worn/faulty.	Replace sensor.
		Sensor cable faulty.	Replace the sensor cable.
		Improper calibration.	Repeat calibration.
U258	Calibration Step Error: Calibration could not be started.	Incorrect configuration (program flows, calibration timer). Do not start 2 calibrations at the same time.	Check and correct the configuration.

Further troubleshooting support can be obtained from → [support@knick.de](mailto:support@knick.de).

## 9.1 Protos Malfunction Message

Malfunction states or indications of a need for maintenance are displayed on the Protos II 4400 with the corresponding NAMUR symbol and listed in the Diagnostics menu. Some messages can also be assigned to individual relay contacts.

- Message list in Diagnostics menu → *Protos Diagnostic Functions, p. 71*
- Configuration of relay contacts → *Relay Contacts, p. 72*

<sup>1)</sup> With automatic Calimatic calibration

<sup>2)</sup> With manual calibration

## 10 Decommissioning

### 10.1 Unical: Removal

**Note:** Cleaning media may contain different hazardous substances. Observe safety instructions.  
→ *Safety, p. 5*

01. Move the retractable fitting into SERVICE position. Press the service switch.
02. Switch off the power supply.
03. Depressurize the process.
04. Switch off and unscrew the compressed air supply.
05. Switch off and unscrew the water supply.
06. Remove the cable from the media adapter.
07. Remove the media connections for retractable fitting, water, compressed air for cleaning and rinsing, and, if necessary, compressed air Aux 2.
08. Remove compressed air for media adapter.
09. Loosen the slotted nut and remove the media connection from the electro-pneumatic controller.
10. Loosen and remove the media connection on the retractable fitting.
11. Drain media from hoses and dispose of if necessary.
12. Remove the media connection from the media adapter.
13. Remove electrical connections from the electro-pneumatic controller.

### 10.2 Return

If required, send the product in a clean condition and securely packed to your local contact.  
→ *knick.de*

If there has been contact with hazardous substances, the product must be decontaminated or disinfected prior to shipment. The consignment must always be accompanied by a corresponding return form (declaration of decontamination) to prevent service employees being exposed to potential hazards. → *knick.de*

### 10.3 Disposal

Local codes and regulations must be observed when disposing of the product.

The Unical 9000 can contain various materials, depending on the version concerned.  
→ *Product Code, p. 10*

Customers can return their waste electrical and electronic devices.

Details on the return and environmentally friendly disposal of electrical and electronic equipment can be found in the manufacturer's declaration on our website. If you have any queries, suggestions, or questions regarding the recycling of waste electrical and electronic equipment from Knick, please send an email to → *support@knick.de*



## 11 Spare Parts and Accessories

### 11.1 Spare Parts



#### Rinse Media Connection

- ZU0572/1 Rinse media connection, length: 5 m; seals: FKM
- ZU0572/2 Rinse media connection, length: 5 m; seals: EPDM
- ZU0573/1 Rinse media connection, length: 10 m; seals: FKM
- ZU0573/2 Rinse media connection, length: 10 m; seals: EPDM
- ZU0652/1 Rinse media connection, length: 15 m; seals: FKM
- ZU0652/2 Rinse media connection, length: 15 m; seals: EPDM

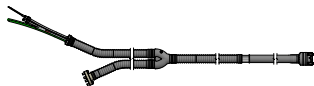

#### Rinse and Calibration Media Connection

- ZU0574/1 Media connection, length: 5 m; seals: FKM
- ZU0574/15 Media connection, length: 5 m; seals: FKM, check valve with steel balls
- ZU0574/2 Media connection, length: 5 m; seals: EPDM
- ZU0575/1 Media connection, length: 10 m; seals: FKM
- ZU0575/2 Media connection, length: 10 m; seals: EPDM
- ZU0932/1 Media connection, length: 14 m; seals: FKM
- ZU0932/2 Media connection, length: 14 m; seals: EPDM
- ZU0653/1 Media connection, length: 17 m; seals: FKM
- ZU0653/2 Media connection, length: 17 m; seals: EPDM



#### ZU0576 Media Interface

The media interface converts pneumatic check-back signals into electrical signals for the electro-pneumatic controller Unical 9000 um. The use of the media interface is only necessary if retractable fittings from other manufacturers are used.

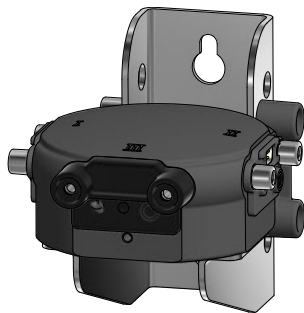

#### ZU0577 Media Adapter

- ZU0577/1 Media adapter, seal: FKM
- ZU0577/2 Media adapter, seal: EPDM
- ZU0577X/1 Media adapter, Ex approval, seal: FKM
- ZU0577X/2 Media adapter, Ex approval, seal: EPDM



### ZU0580 Metering Pump With Container 3.5 L

ZU0580/1 Metering pump (PP, FKM) with container 3.0 l

ZU0580/2 Metering pump (PP, EPDM) with container 3.0 l

ZU0580/2S Metering pump (PP, EPDM) with container 3.0 l with steel in place of glass balls

ZU0580X/1 Metering pump (PP, FKM) with container 3.0 l, Ex

ZU0580X/2 Metering pump (PP, EPDM) with container 3.0 l, Ex



### ZU0729 Service Switch

ZU0729 NC service switch for Unical 9000-NC\*\*\*\*\*\_\*\*\*

ZU0729 XC service switch for Unical 9000-XC\*\*\*\*\*\_\*\*\*

ZU0729 NS service switch for Unical 9000-NS\*\*\*\*\*\_\*\*\*

ZU0729 XS service switch for Unical 9000-XS\*\*\*\*\*\_\*\*\*

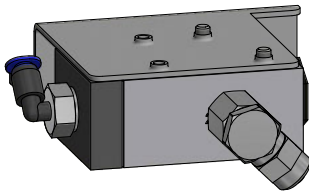

### ZU0587 Supplementary Air Purging Kit

ZU0587(X) is a 3/2-way valve (3 connections, 2 switch positions). It controls the purge air for sensor cleaning in the calibration chamber of the retractable fitting.

The accessory is approved for use in hazardous locations.



### ZU0632 Air Pressure Switch

Pressure switch for monitoring the compressed air

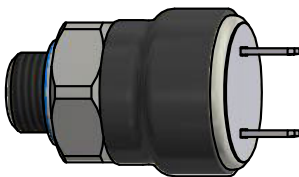

### ZU0633 Water Pressure Switch

Pressure switch for monitoring the water pressure

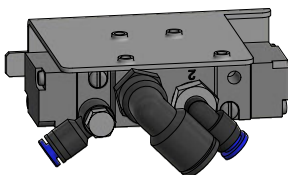

### ZU0634 Valve for Retractable Fitting, Complete

Control valve as 5/2-way valve

2 connections for retractable fitting movement

1 connection to pilot valve

1 connection for air supply

1 connection for venting

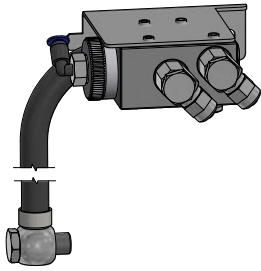
**ZU0714 Water Valve**

Control valve as 3/2-way valve  
 2 output connections for water  
 1 connection to pilot valve  
 1 connection for water supply

**ZU0644 Sensor Dismount Guard, Complete**

The sensor dismount guard measures the pressure drop or variations during operation of the retractable fitting.

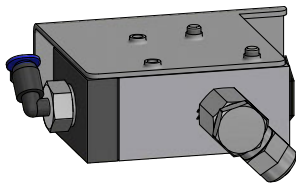
**ZU0636 Air Purge Valve, Complete**

Control valve as 3/2-way valve  
 1 connection for air purging  
 1 connection to pilot valve  
 1 connection for venting

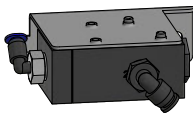
**ZU0637 Aux2 Valve, Complete**

Control valve as 3/2-way valve  
 1 connection with inductor for air purging  
 1 connection to pilot valve  
 1 connection for venting

**ZU0641 Replacement Filter Housing**

For filtering out the oil from the supplied compressed air

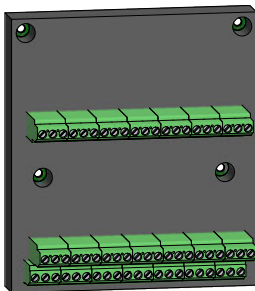
**ZU0642 Electronics Assembly Group**

ZU0642 Electronics assembly group, tested, potted  
 ZU0642/1 Electronics assembly group, tested, potted, with Ex approval

**ZU0813/1 Reed Switch, Short**

Service component for multiplug.

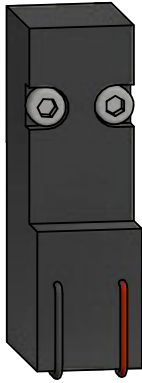

**ZU0638 Piezo Valve for Valve Block, Complete**

Valve for regulating the compressed air



**ZU0639 Seal for Port on Media Adapter**

EPDM seal

**ZU0640 Filter Insert**

Filter insert 5 ... 10 µm for compressed air filter

**ZU0643 Small Accessory Parts Kit**

Various screws, springs, etc.

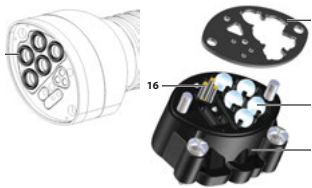

**ZU0812 Multiplug Service Set, Bottom Part**

ZU0812/1 Multiplug service set, FKM seal  
 ZU0812/2 Multiplug service set, EPDM seal  
 ZU0812/3 Multiplug service set, FFKM seal  
 Conversion kit for replacing the O-rings and seals of the multiplug bottom part



**ZU0984 Manometer Replacement Kit**

For replacing the water manometer or compressed air manometer

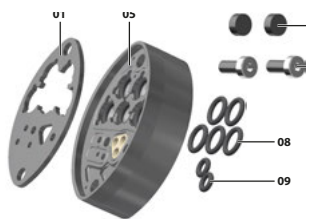

**ZU1067 Multiplug Service Set, Middle Part**

ZU1067/1 Multiplug service set, FKM seal  
 ZU1067/2 Multiplug service set, EPDM seal  
 ZU1067/3 Multiplug service set, FFKM seal  
 Conversion kit for replacing the O- rings and seals of the multiplug middle part

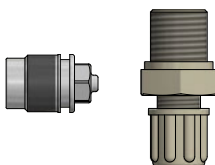

**ZU0933 Pump Check Valve Set, Unical 9000/Uniclean 900**

ZU0933/1 Sealing ring material: FKM  
 ZU0933/2 Sealing ring material: EPDM

## 11.2 Accessories



### ZU0601 Pipe-Mount Kit for Unical 9000

For installation of the Unical 9000 electro-pneumatic controller on a horizontal or vertical pipe

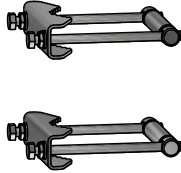

### ZU0606 Pipe-Mount Kit for Media Adapter

For installation of the media adapter with metering pumps on a horizontal or vertical pipe.



### ZU0656 Water and Air Connection Kit for Unical 9000

Connection kit for supplying water and air to the Unical 9000 electro-pneumatic controller.

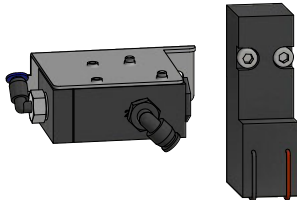

### ZU0588 Extension Kit Auxiliary Valve Aux 2

Contains:

- Pilot valve for valve block
- Control valve Aux 2
- Tubing  $\varnothing$  4 x 2.7 mm, black
- M5 nut

### ZU0649 Unical 9000 Commissioning

Commissioning includes:  
the device hoses and cables,  
commissioning itself,  
instruction for the operating personnel.

### ZU0741 Chemical Pump

**Note:** Supplementary external valve kit required.

The chemical pump is used for pumping cleaners not compatible with the standard PP and EPDM or Viton pump.

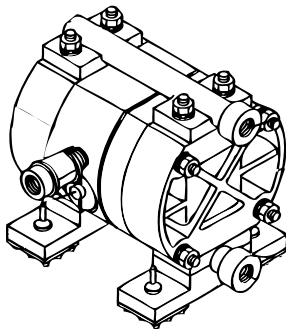



### RV01 Check Valve

The RV01 check valve prevents process medium or calibration, cleaning, or rinse media from flowing back into the inlet. The check valve is selected using a product code.

Check valve		RV01	-	-	-	-	-
Housing material, valve body	Stainless steel 1.4404			H			
	PEEK			E			
Seal material	FKM				A		
	EPDM				B		
	FFKM				C		
	FKM-FDA				F		
	EPDM-FDA				E		
	FFKM-FDA				H		
Inlet connection, female thread	G $\frac{1}{4}$ "					4	
	G $\frac{1}{8}$ "					8	
Outlet connection, male thread	G $\frac{1}{4}$ "						4
	G $\frac{1}{8}$ "						8

## 12 Dimension Drawings

**Note:** All dimensions are given in millimeters [inches].

### Unical 9000 Wall Mounting

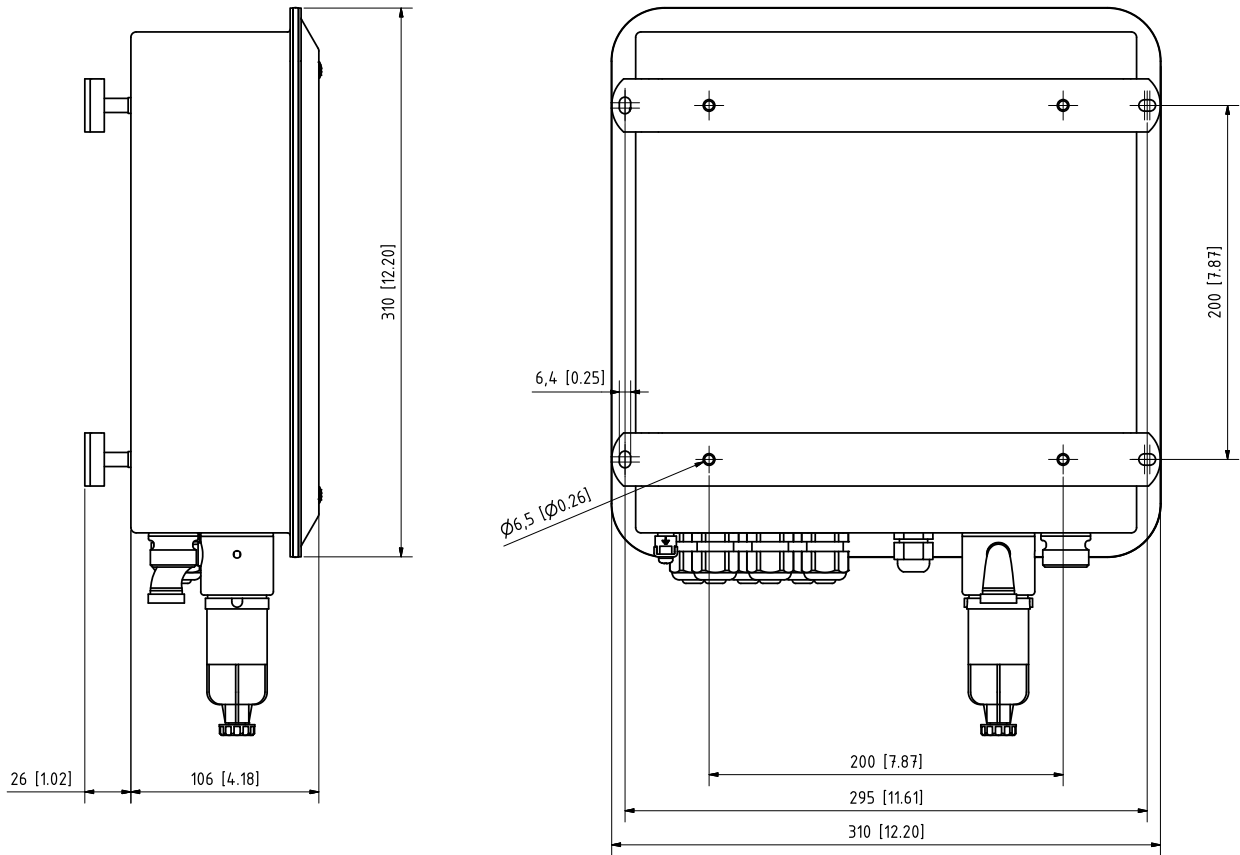

**Unical 9000 Pipe Mounting**

**Note:** All dimensions are given in millimeters [inches].

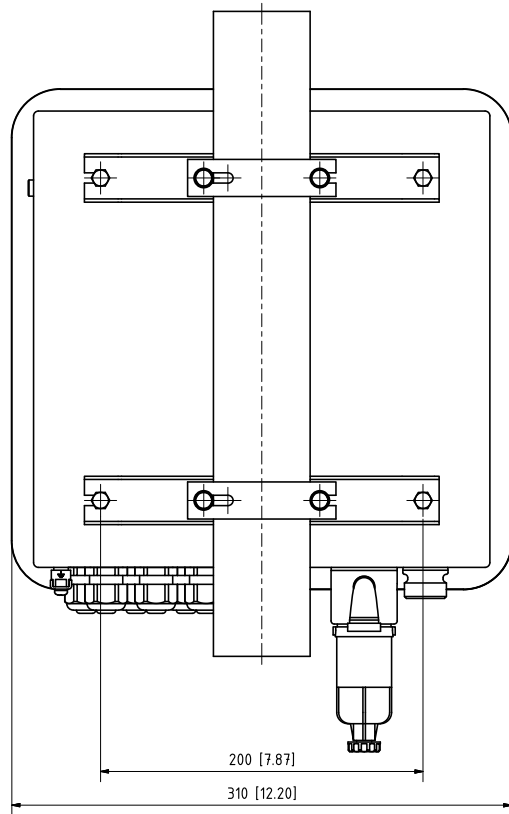
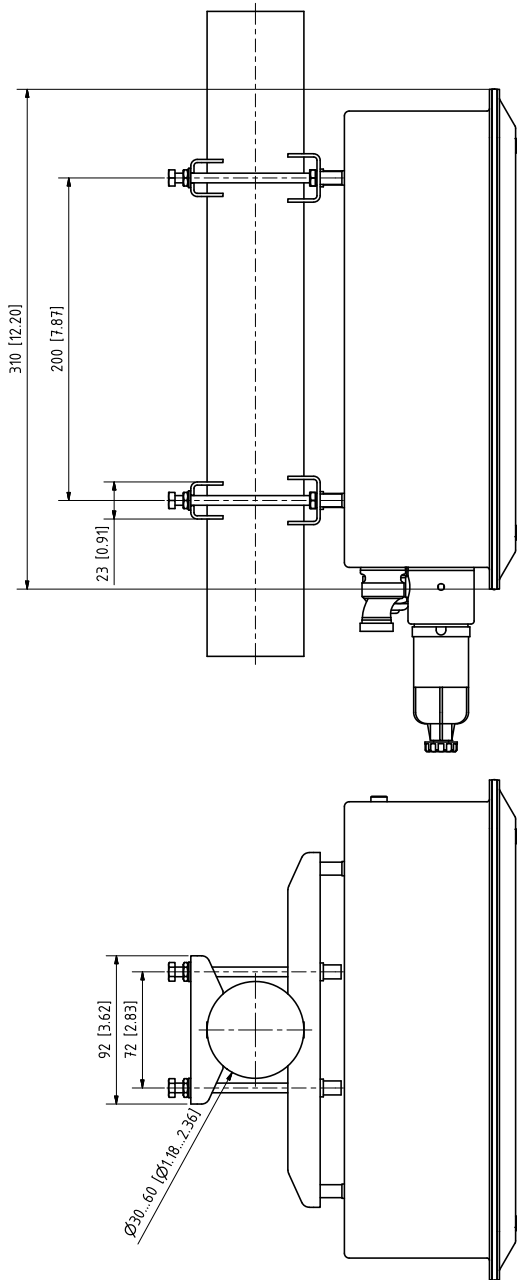

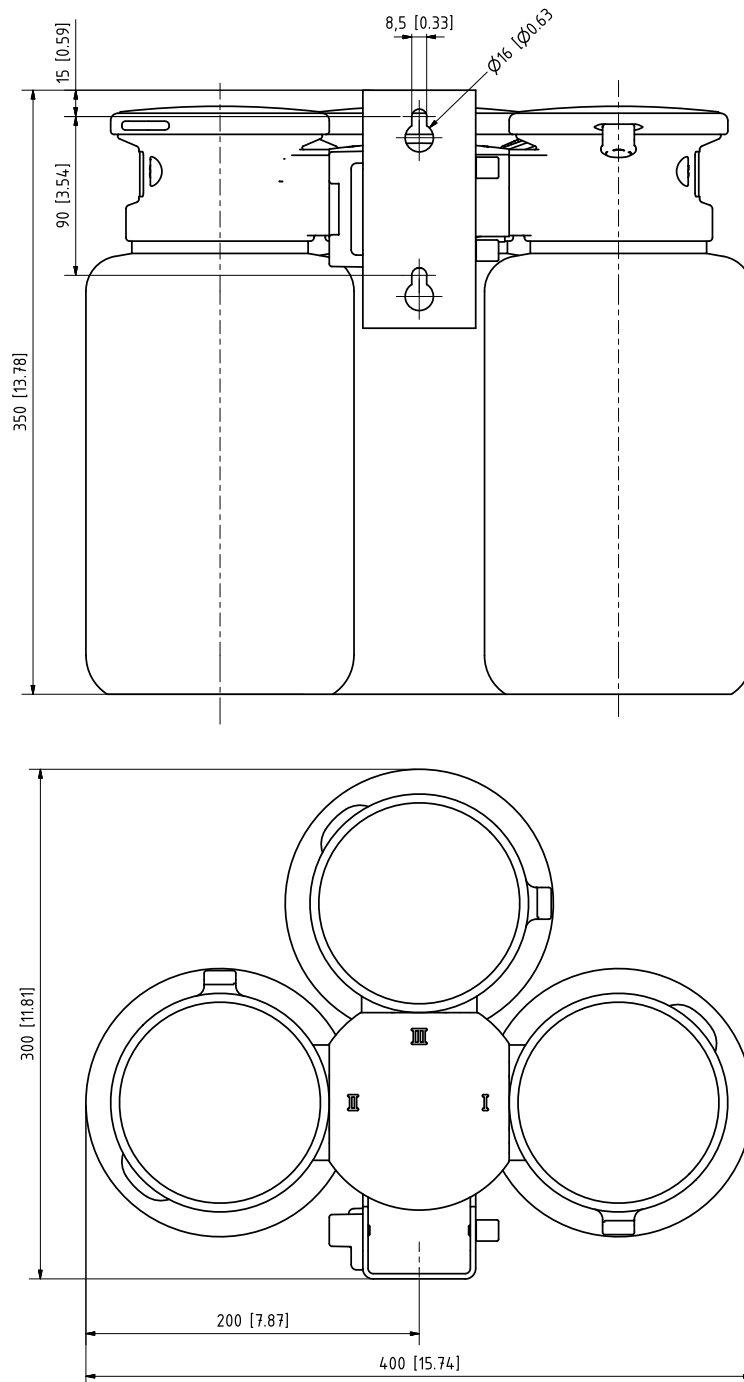

**Media Adapter****Note:** All dimensions are given in millimeters [inches].

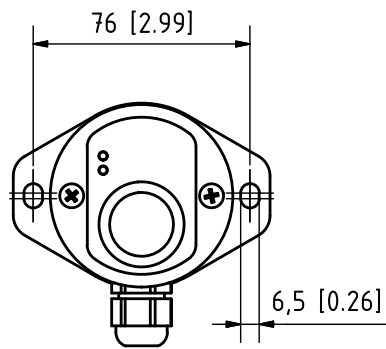
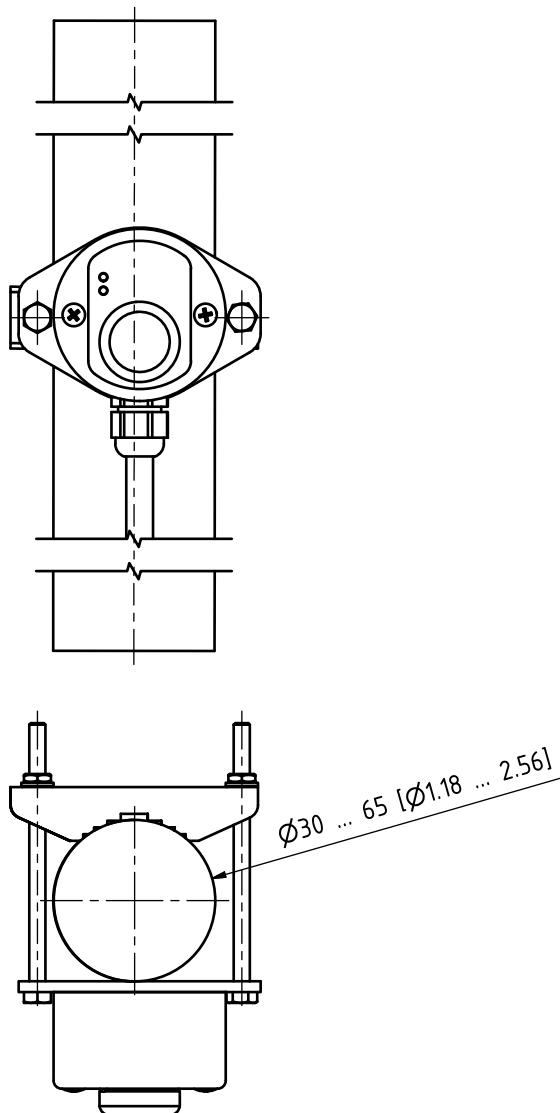
**Service Switch Wall Mounting****Note:** All dimensions are given in millimeters [inches].**Service Switch Pipe Mounting****Note:** All dimensions are given in millimeters [inches].

## 13 Specifications

### Compressed Air

Quality of compressed air according to ISO 8573-1:2001	Quality class 5.3.3
Solid contaminants	5 (max. 40 µm, max. 10 mg/m <sup>3</sup> )
Water content for temperatures ≥ 15 °C (59 °F)	Class 4 <sup>1)</sup>
Water content for temperatures 5 ... 15 °C (41 ... 59 °F)	Class 3, pressure dew point -20 °C (-4 °F) or lower
Oil content	Class 3 (max. 1 mg/m <sup>3</sup> )
Perm. pressure range	4 ... 10 bar (58 ... 145 psi) <sup>2)</sup>
Retractable fitting operating pressure	4 ... 7 bar (58 ... 101.5 psi) <sup>2)</sup>
Pressure monitoring	Automatic monitoring, message
Connection	G <sup>1</sup> / <sub>4</sub> " female thread
Air consumption	Max. 300 l/min during actuation of the retractable fitting
Min. air temperature	5 °C (41 °F)

### Rinse water

Filtered	100 µm
Permissible pressure range	2 ... 6 bar (29 ... 87 psi)
Temperature range	5 ... 65 °C (41 ... 149 °F)
Pressure monitoring	Automatic monitoring, message
Connection	Female thread G <sup>1</sup> / <sub>4</sub> " or male thread G <sup>3</sup> / <sub>4</sub> "

### Media adapter with metering pumps

Number of push-in connections	3
Ports I and II	Calibration buffer
Port III	Cleaner
Material	
Blind plate	PP-GF <sup>3)</sup>
Seal	EPDM <sup>4)</sup>
Enclosure	PP-H
Media connection seal	FKM/EPDM <sup>5)</sup>
Degree of protection	IP65
Installation	Wall or pipe mounting (option)

### Metering pumps

Application	For calibration or cleaning media
Container capacity	3.0 L
Max. lifting height	10 m
Displacement	Approx. 25 cm <sup>3</sup> /stroke
Fill level monitoring	Unical sensor diagram and NAMUR messages: Maintenance Required and Failure

<sup>1)</sup> At operating temperatures > 15 °C (59 °F) a pressure dew point of max. 3 °C (37.5 °F) is permissible.

<sup>2)</sup> Increased minimum pressure 5 bar (72.5 psi) for retractable fitting required for high process pressure or difficult process media.

<sup>3)</sup> Non-process-wetted

<sup>4)</sup> An FKM seal is supplied with the FKM pump.

<sup>5)</sup> Dependent on the version

**Media adapter with metering pumps**

Material	
Pump cover	FKM/EPDM <sup>1)</sup>
Pump diaphragm	FKM/EPDM <sup>1)</sup>
Pump housing	PP-GF
Pump head	PP-GF
Float	PP
Float tube	PVDF
Container	PE-HD
Check valves	
Ball	Glass
Spring	Hastelloy
Seal	FKM/EPDM <sup>1)</sup>
Degree of protection	IP65
Dimensions	See Dimension Drawing → <i>Dimension Drawings, p. 95</i>

**Service switch**

Signaling	Via LEDs → <i>Service Switch Design and Function, p. 19</i>
Material	Stainless steel A4, polished or POM
Degree of protection	IP65
Installation	Wall or pipe mounting
Dimensions	90 x 65 x 43 mm (3.54 x 2.56 x 1.69 inches)

**Media connection**

Corrugated hose with 1 cable and 8 media hoses (4x from Unical to retractable fitting, 1x from Unical to media adapter, 3x from media adapter to retractable fitting)

Dimensions	Ø 30 mm, hose end multiplug: Ø 28 mm, lengths → <i>Installation, p. 21</i>
Material	
Unical joining piece	1.4571
Corrugated hose	PVC and metal spiral
Media adapter compressed air hose DN 6	FEP
Service position compressed air hose DN 6	PA
Process position compressed air hose DN 6	PA
Hose for cleaning and rinsing DN 6 (2x)	FEP
Hose for calibration media, DN 6 (2x)	LD-PE
Hose for cleaning medium, DN 6	FEP
Hose end multiplug	EPDM
Hose manifold	PP-H
Media adapter joining piece	PP-H
Multiplug	PEEK
Check valve multiplug	
Ball (5x)	Glass <sup>2)</sup>
Spring (2x)	Hastelloy
Seals	FKM/EPDM/FFKM <sup>1)</sup>

<sup>1)</sup> Dependent on the version

<sup>2)</sup> Other materials on request

**Ambient conditions**

Ambient temperature (operation) <sup>1) 2)</sup>	Non-Ex: 2 ... 55 °C (35,6 ... 131 °F) Ex: 2 ... 50 °C (35.6 ... 122 °F)
Transport / storage temperature	-20 ... 70 °C (-4 ... 158 °F)
Relative humidity	10 ... 95 %, not condensing

**Degree of protection**

Degree of protection	IP65/NEMA 4X
Cable glands	6 cable glands M20 x 1.5
Weight	Approx. 8.5 kg

**Housing**

Housing surface S	Stainless steel A2, polished
Housing surface C	Stainless steel A2, coated Color: pigeon blue
Installation	Wall or pipe mounting (option)
Dimensions (W x H x D)	Approx. 310 x 410 x 135 mm (12.2 x 16.1 x 5.31 inches)
Degree of protection	IP65 / NEMA 4X
Cable glands	6 cable glands M20x1.5
Weight	Approx. 8.5 kg

**Power connection**

Power supply (Ex ia IIC) <sup>3)</sup>	Power supply by Protos module: 6.8 V (± 10 %) / 15 mA by external power source 15 ... 30 V / 20 mA
Connection <sup>4)</sup>	Terminals, conductor cross-section max. 2.5 mm <sup>2</sup>

**Interfaces**

RS 485 (Ex ia) <sup>3)</sup>	Communication with Protos module or external control computer (e.g., PCS)
Transmission	1200 Baud/8 Data Bit/1 Stop Bit/Parity Odd
Protocol	HART Rev. 5
Connection <sup>4)</sup>	Terminals, conductor cross-section max. 2.5 mm <sup>2</sup>

**External control**

PCS inputs (passive)	
Terminals 37 ... 39: Bin1 ... 3 (Ex ia IIC)	Program start P1 ... P6, U <sub>i</sub> = 30 V, floating, interconnected, galvanic isolation up to 60 V
Switching voltage	Active signal level < 2 V AC/DC bzw. 10 ... 30 V AC/DC, configurable
Connection	Conductor cross-section max. 2.5 mm <sup>2</sup>
Terminals 40 ... 41: Auto/Manual (Ex ia IIC)	Enable automatic program starts, U <sub>i</sub> = 30 V, floating, galvanic isolation up to 60 V
Switching voltage	Active signal level < 2 V AC/DC bzw. 10 ... 30 V AC/DC, configurable
Connection	Conductor cross-section max. 2.5 mm <sup>2</sup>
Terminals 42 ... 43: Process/Service (Ex ia IIC)	Start service mode, U <sub>i</sub> = 30 V, floating, galvanic isolation up to 60 V
Switching voltage	Active signal level < 2 V AC/DC bzw. 10 ... 30 V AC/DC, configurable
Connection	Conductor cross-section max. 2.5 mm <sup>2</sup>

<sup>1)</sup> Other temperature ranges possible on request

<sup>2)</sup> To ensure safe and frost-free operation, the ambient temperature should not fall below 5 °C (41 °F).

<sup>3)</sup> In hazardous locations, observe EU-Type Examination Certificate.

<sup>4)</sup> Pre-assembled cable to the industrial transmitter. Length 10 m

**External control**

## PCS output (passive)

Terminals 32 ... 34: Program Running, Service, Process/Alarm (Ex ia IIC)	Check-back signals: Program Running, Service Position, Process Position Electronic relay contacts, floating, interconnected
---	--

Maximum load

Non-Ex:  $U_i = 30 \text{ V}$   $I_i = 100 \text{ mA}$   
 Ex:  $U_i = 30 \text{ V}$   $I_i = 100 \text{ mA}$   $P_i = 800 \text{ mW}$ ,  
 galvanic isolation up to 60 V

Voltage drop

&lt; 1.2 V

Connection

Conductor cross-section max. 2.5 mm<sup>2</sup>**Conformity**

Explosion protection Unical 9000-X

See EU-Type Examination Certificate and EU Declaration of Conformity

EMC

EN 61326

Lightning protection

EN 61000-4-5, installation class 2

Protection against electric shock

According to EN 61010



**Media Connection Pneumatic Circuit Diagram**

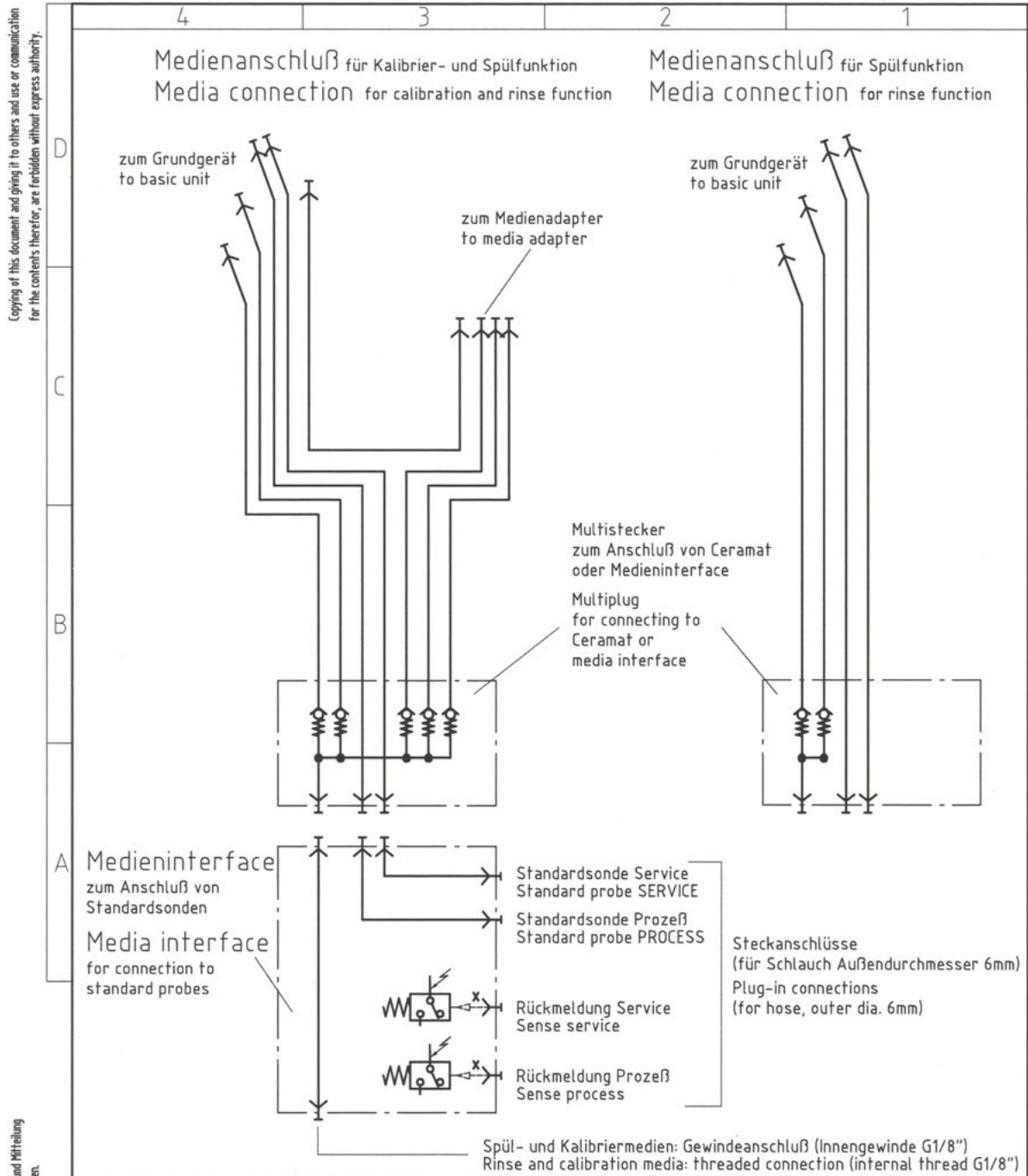

















Copying of this document and giving it to others and use or communication for the contents therefor, are forbidden without express authority.

Weitergabe sowie Vervielfältigung dieser Unterlage, Verwertung und Mitteilung ihres Inhalts nicht gestattet, soweit nicht ausdrücklich zugestanden.

Verteiler: FUL (2x)		Zul. Abweichungen für Maße ohne Toleranzangabe ISO 2768 - m		Oberfläche	Maßstab
		Datum		Benennung	
		Name		Pneumatikschaltbild Unical 9000 Medienanschluß und Medieninterface	
		Bearb. 17.08.04 bos		Pneumatic diagram Unical 9000 Media connection / Media interface	
		Gepr.(KON) 18.08.04 S		Zeichnungsnummer	
		Freigabe(FGL) 18.08.04 W		207.011-250	
		Schutzvermerk nach DIN 34 beachten			
		<b>Knick</b> 			
Nr. AE	Datum	Bearbeiter	FGL KON	Elektronische Messgeräte GmbH & Co. KG	Ungültig ab:
					Ersetzt durch:



## 14.2 Symbols and Markings on the Display

	<p>Function check in accordance with NAMUR NE 107  <i>Wrench symbol in upside-down triangle</i>          The NAMUR "HOLD" contact is active. Current outputs as configured:          Currently measured value: The currently measured value appears at the current output.          Last measured value: The last measured value is held at the current output.          Fixed value: The current output supplies a fixed value.</p>
	<p>Out of specification in accordance with NAMUR NE 107  <i>Black question mark in triangle</i>          The NAMUR "Out of Specification" contact is active.          Error message: <a href="#">Diagnostics</a> ▶ <a href="#">Message List</a></p>
	<p>Failure in accordance with NAMUR NE 107  <i>Blinking black cross icon in circle</i>          The NAMUR "Failure" contact is active.          Error message: <a href="#">Diagnostics</a> ▶ <a href="#">Message List</a></p>
	<p>Maintenance required in accordance with NAMUR NE 107  <i>Oil can icon in square</i>          The NAMUR "Maintenance Required" contact is active.          Error message: <a href="#">Diagnostics</a> ▶ <a href="#">Message List</a></p>
	<p>The device is in calibration mode. Function check (HOLD) is active for the calibrated module.</p>
	<p>The device is in maintenance mode. Function check (HOLD) is active.</p>
	<p>The device is in parameter mode. Function check (HOLD) is active.</p>
	<p>The device is in diagnostics mode.</p>
	<p>Indicates the active parameter set. (The device provides two parameter sets A and B. Up to 5 sets can be added using add-on functions and memory card)</p>
	<p>When in measuring mode, Sensoface smileys indicate the quality of the sensor data:          Happy</p>
	<p>Neutral</p>
	<p>Sad</p>
	<p>A "closed" Data Card (memory card) is located in the device. The memory card can be removed. If you want to continue using the card, select "Open Memory Card" in the Maintenance menu.</p>
	<p>There is an enabled Data Card (memory card) in the device.  <b>Note:</b> Select "Close Memory Card" in the Maintenance menu before removing the memory card.</p>
	<p>There is an FW Update Card (memory card) in the device. You can save the current device firmware or perform a firmware update from the memory card  <b>Note:</b> Check the parameter settings after updating.</p>
	<p>Free firmware repair in the event of device errors. The TAN option FW4400-106 is not required here.          General data cannot be stored on this card.</p>

	Designates the module port (1, 2, or 3) with indication of the channel number for multi-channel modules, allowing the clear assignment of measured value/parameter displays in the case of identical module types.
	
	To the left of a menu line that contains a further menu level. Pressing <i>Enter</i> opens the submenu.
	To the left of a menu line that, at administrator level, can be blocked from access at operator level.
	To the left of a menu line that, at administrator level, was blocked from access at operator level.
	To the left of a Diagnostics menu item set as a "Favorite".
	Delta function is active (output value = measured value - delta value)
	Hourglass indicates that a waiting time is running.
	Limit indication: Lower/upper range limit exceeded.
	
	Calibration: Step 1 of product calibration has been executed. The device is waiting for the sample values.
TC	Calibration: Temperature compensation for process medium is active.
	Sensocheck
	COMFF module: Control via FOUNDATION Fieldbus
	COMPA module: Control via PROFIBUS-PA
	PN module: PROFINET control
	Context menu: Open with the <i>right softkey</i> .
	MSU module: Metering pump for port I, II, or III
	MSU module: Valve for rinse medium



MSU module: Valve for additional medium Aux 1 or Aux 2



Retractable fitting is in process position (probe in PROCESS).



Retractable fitting is in service position (probe in SERVICE).



Probe moving.



Service mode is active. (Example: Probe in SERVICE) → *Service Mode, p. 74*







No Unical connected or no connection to Unical.



Display in status line: Unical is Active.

### 14.3 Overview of Unical Messages









See the relevant Protos User Manual for further message texts

Message type	NAMUR icon
Maintenance required	
Out of specification	
Failure	
Function check	



















Most messages can also be signaled via PROFIBUS (when using a COMPA module) and/or relay contacts; see the table below.





For signaling via PROFIBUS, see the COMPA module User Manual.

For signaling via relay contacts → *Relay Contacts, p. 72*

No.	Type	Message text	Message list	Logbook	Can be signaled via	
					PROFIBUS	Contacts
U001		Configuration Data Loss	x	x		x
U010		Probe in SERVICE		x		
U011		Probe in PROCESS		x		
U012		Service Switch Actuated		x		
U030		Start Program		x		
U031		End Program		x		
U190 U191 U192		Container I/II/III Almost Empty	x	x	x	x
U194 U195 U196		Container I/II/III Empty	x	x	x	x
U217		Immersion Lock: Sensor Not Connected	x	x		x
U218		Immersion Lock: Sensocheck Glass Electrode	x	x		x
U200		Function Check by Unical <sup>1)</sup>	x	x		x
U219		Firmware Error	x	x		x
U220		Compressed Air Sensor	x	x	x	x

<sup>1)</sup> Function check (HOLD) is activated for the assigned sensor channel.

No.	Type	Message text	Message list	Logbook	Can be signaled via	
					PROFIBUS	Contacts
U221		Immersion lock	x	x	x	x
U222		Undefined Safety State	x	x		x
U224		Leakage Sensor	x	x	x	x
U225		Probe Valve Defective	x	x	x	x
U227		Probe SERVICE Limit Position	x	x	x	x
U229		Sensor Dismount Guard Defective	x	x	x	x
U230		Probe PROCESS Limit Position	x	x	x	x
U231		Probe PROCESS Travel Time	x	x	x	x
U233		Water Pressure Sensor	x	x	x	x
U234		Probe SERVICE Travel Time	x	x	x	x
U235		Safety Valve Defective	x	x	x	x
U236 U237 U238		Metering Pump I/II/III Parameter Setting	x	x		x
U239 U240		Aux 1/Aux 2 Parameter Setting	x	x		x
U241		Rinse Medium Monitoring	x	x	x	x
U242 U243 U244		Medium I/III/III Monitoring	x	x	x	x
U245 U246		Aux 1/Aux 2 Monitoring	x	x	x	x
U248		Water Valve Defective	x	x	x	x
U249		Probe Check Counter	x	x		x
U250		Probe Maintenance Counter	x	x		x

No.	Type	Message text	Message list	Logbook	Can be signaled via	
					PROFIBUS	Contacts
U251		Calibration Error pH	x	x	x	x
U252		Communication Error	x	x	x	x
U255		Calibration Error ORP	x	x	x	x
U256		Unclean Not Supported	x	x		x
U257		Hardware 1 Not Supported	x	x		x
U258		Calibration Step Error		x		

## Abbreviations

A/F	Width across flats
Aux	Auxiliary medium
bn	Brown
bu	Blue
CIP	Cleaning in place
DN	Diamètre nominal (nominal size)
EMC	Electromagnetic compatibility
EN	European standard
EPDM	Ethylene propylene diene monomer rubber
Ex	Explosion protected
FDA	U.S. Food and Drug Administration
FFKM	Perfluoro rubber
FKM	Fluoro rubber
FW	Firmware
GN	Green
GND	Ground
GY	Gray
HART	Highway addressable remote transducer
IEC	International Electrotechnical Commission
IP	International Protection / Ingress Protection
NAMUR	User Association of Automation Technology in Process Industries
N/C	Normally closed (contact)
NE 107	NAMUR recommendation 107: "Monitoring and Diagnosis of Field Devices"
NEMA	National Electrical Manufacturers Association, US
N/O	Normally open (contact)
PCS	Process control system
PEEK	Polyether ether ketone
PE-HD	High-density polyethylene
pk	Pink
PP	Polypropylene
PP-GF	Glass fiber reinforced polypropylene
PP-H	Polypropylene homopolymer
PVDF	Polyvinylidene fluoride
T <sub>amb</sub>	Permissible ambient temperature
TAN	Transaction number
USP	U.S. Pharmacopeia
wh	White
ye	Yellow
ZU	Accessories

## Index

### A

Abbreviations	111
Accessories	93
Additional media	
Control valves	27
Parameter setting	65

### C

Cable lengths	21
Calibration	
Unical controller	61
Calibration timer	
Unical controller	44
Certificate	7
Check counter	77
Cleaning media	67
Commissioning	41
Commissioning Program	66
Container with metering pump	19
Filling the containers	67
Continuous measurement	62
Control programs	
General	48
Control valves	27

### D

Declaration of decontamination	88
Declaration of no objection	88
Decommissioning	88
Diagnostic functions	71
Disposal	88

### E

Electrical installation	34
Electrostatic discharge	7
Environmental damage	5
Equipment	7
Error messages	83

### F

Fill level monitoring	
Manual control	75
Network diagram	71
Fixed interval	45

### G

General installation instructions	21
Genuine spare parts	8

### H

Hazardous locations	7
Hazardous substances	7
Housing materials	10

### I

Icons	105
Immersion lock	62
Initial commissioning	41
Parameter Setting	44
Installation	
Electrical	34
Industrial transmitter	33
Mechanical	22
Parameter Setting menu	62
Pipe mounting	24
Retractable fitting	33
Wall mounting	22
Installation location	7
Intended use	5
Introductory safety chapter	2

### L

LED, service switch	19
---------------------	----

### M

Maintenance	74
Maintenance counter	77
Maintenance functions	74
Manual control	75
Passcode	62
Measurement procedure	62
Mechanical installation	22
Media adapter	18
Dimension drawing	97
Parameter setting	65
Media adapter with metering pumps and containers	
Design and function	18
Installation	33
Pipe mounting	25
Wall mounting	23
Media connection	
Design and function	20
Dimensions	22
Installation	26
Media monitoring	66
Media supply	16
Message list	
Diagnostics menu	71
Overview	108
Metering pump with container	19
Filling the containers	67
Mixed equipping	7
Model designation	
Coding	9

### N

Nameplate	11
NAMUR symbols	108
Network diagram	71
Notes on safety information	2



**O**

Operation in hazardous locations	7
Order code	9, 10

**P**

Package contents	9
Personnel	5
Personnel requirements	5
Pilot valves	17
Functional test	78
Pipe mounting	
Media adapter with metering pumps and containers	25
Service switch	25
Unical 9000	24
Pneumatic circuit diagrams	103
Port	18
Recommended medium	67
Preventive maintenance	8
Probe wear	77
Process control system PCS	
Start program	48
Product code	9, 10
Program flows	48, 51
Program steps	49
Programs	48
Progress display	69
Property damage	5
Protos parameter setting	42
Pump with container	19

**Q**

Qualified personnel	5
---------------------	---

**R**

Recycling	88
Relay contacts	
Parameter Setting	72
Repair Service	82
Reset counter	77
Residual risks	6
Retractable fitting supply	16
Return of waste equipment	88
Return form	88
Returns	88
Risk assessment	6

**S**

Safeguards	6
Safety chapter	5
Safety datasheets	7
Safety instructions	2
Safety valve	6
Seal	10
Sensor dismount guard	6
Service mode	74
Service program	
General	48
Program flow	59
Service switch	
Design and function	19
Dimension drawing	98
Electrical installation	38
Pipe mounting	25
Wall mounting	23
Short-time measurement	62
Spare parts	89
Special versions	10
Starting the program	48
Supplemental directives	2
Supply connections	27
Symbols and markings	
Display	105
Product	13

**T**

Terminals	17
Time control	45
Troubleshooting	83
Type designation	9

**U**

Unical 9000 design	14
Unical messages	108

**V**

Valve block	17
Versions	9

**W**

Wall mounting	
Media adapter with metering pumps and containers	23
Service switch	23
Unical 9000	22
Warnings	2
Water leakage, detection	6
Weekly program	46
Wiring	35



**Knick**  
**Elektronische Messgeräte**  
**GmbH & Co. KG**

**Headquarters**

Beuckestraße 22 • 14163 Berlin  
Germany  
Phone: +49 30 80191-0  
Fax: +49 30 80191-200  
info@knick.de  
www.knick.de

**Local Contacts**

www.knick-international.com

Translation of the original instructions  
Copyright 2023 • Subject to change  
Version 2 • This document was published on July 19, 2023.  
The latest documents are available for download on our  
website under the corresponding product description.

TA-207.300-KNEN02



101434